

Systems Reference Library

IBM System/360 and System/370 Bibliography

This bibliography identifies and describes all literature in or related to the Systems Reference Library for the System/360, Model 25 and above, and for System/370. Part 1 is a list of subject codes with publication types shown for each code. Part 2 is a set of publications selector charts for machines and programming systems. These charts are quick and comprehensive guides for locating documents about specific machines or programs. Part 3 provides abstracts of all publications in form-number sequence.

When you order the bibliography, you also get the current SRL Newsletter, Order Number GN20-0360, which should always be used with the bibliography.

Publications relating to the Model 20 are in the *IBM System/360 Model 20 Bibliography*, Order Number GA26-3565. Another publication of interest to the user of System/360 is the Order Number GA24-3089.

Systems Reference Library

For each major IBM data processing system, a Systems Reference Library (SRL) contains all basic reference literature needed to plan, program, install, and operate the system. An SRL Bibliography Supplement, Form A24-3089, covers publications for IBM teleprocessing and data collection equipment. The *Bibliography of Data Processing Techniques*, Form F20-8172, lists selected IBM technique-oriented publications that are applicable to many types of systems.

Bibliography

The bibliography is always associated with the *System/360 SRL Newsletter*, Form N20-0360. When you order the bibliography, you receive the SRL Newsletter. The bibliography provides publications selector charts to aid in quickly finding publications related to specific system models, input/output devices, and programming systems. Additionally, abstracts for all current System/360 SRL publications (except those pertaining to the Model 20) are given in form number sequence.

By reviewing the contents of this bibliography, you may select items of interest for your installation and be aware of other materials that may be useful in the future.

File Numbers, Subject Codes

The cover page of each SRL manual shows the title, abstract, form number, and file number. The file number identifies the system or component discussed and the general subject area.

For publications associated with one or two Libraries, the prefix of the file number is the system type (e.g., S360-, 1130/1800-). When the publication is included in more than two Libraries, the component types (e.g., 1403-, 1418/1428-) are used, if applicable. In other cases "GENL" (general) is used.

The suffix of the file number is the subject code which designates a general subject area and the suggested filing sequence. Code 15, for example, is used for all publications related to physical planning specifications; code 33 appears on all publications related to IBM sort and merge programs for the system. See Part 1 for the list of subject codes and areas covered.

In the bibliography, the subject code for any publication appears to the upper right of its abstract.

Sixteenth Edition (March, 1971)

This is a major revision of, and obsoletes, GA22-6822-15 and all associated SRL Newsletters. Part 1 now contains a numeric-order list of Library subject codes with areas of coverage indicated. Part 2 provides publications selector charts to aid the user in finding documentation for System/360 and System/370 machines and programming systems.

Requests for copies of IBM publications should be made to your IBM representative or to the IBM branch office serving your locality.

A complete list of publications appears as an accumulative index in subject-code sequence in the *System/360 SRL Newsletter*, Form GN20-0360.

Technical Newsletters

To keep publications current, additions and other modifications are distributed as Technical Newsletters (TNLS). The TNL masthead carries the file number and form number of the publication to which it applies. Also, all previously issued TNLS are listed so that you may verify receipt of all changes.

SRL Newsletter

The *System/360 SRL Newsletter*, Form GN20-0360, is issued every four weeks (if changes have occurred during that period) to update the System/360, System/370 Bibliography. All current publications are listed in subject code sequence. Each entry shows the form number and title of the publication as well as the form numbers of applicable TNLS. Obsolete publications are listed separately, with replacement form numbers (if any) indicated. Abstracts of new publications are also included.

The SRL Newsletter gives the form number suffix so that you may verify your publications as current. Some publications have more than one current edition, since a reprint that incorporates previously distributed replacement pages is given a new suffix. All current editions and applicable TNLS are listed in the SRL Newsletter.

SRL Subscription Service

A direct-mail service is available to IBM system users to supply new publications, major revisions, and Technical Newsletters for a library that is formed and maintained according to a profile of the user's interests.

To subscribe, see your local IBM representative.

IBM Programming Systems

SRL Newsletters also show the current status of programming systems available for a system. Additional data, including ordering instructions, for these and application programs are in the *Catalog of Programs for IBM System/360*, Form GC20-1619.

- | | | | |
|----|---|----|--|
| 00 | General Information
Bibliographies, System Summaries, Configurators | 26 | ALGOL |
| 01 | Machine System
Principles of Operation, Functional Characteristics, Operating Procedures | 28 | Report Program Generator (RPG) |
| 03 | Input/Output
Component Descriptions | 29 | PL/I |
| 05 | Magnetic Tape Units and Controls
Component Descriptions, Operator Cards | 30 | Input/Output Control System (IOCS), Data Management |
| 07 | Direct Access Storage Units and Controls
Component Descriptions, Handling Procedures | 31 | System Service Programs |
| 09 | Teleprocessing Equipment
Component Descriptions | 32 | Utility Programs |
| 10 | Auxiliary Equipment
Component Descriptions | 33 | Sort/Merge |
| 13 | Special and Custom Features
Special Feature Descriptions, Custom Feature Descriptions | 35 | Simulation, Emulation |
| 15 | Physical Planning Specifications
Installation Manuals—Physical Planning | 36 | Control Programs |
| 19 | Original Equipment Manufacturers' Information | 37 | Automatic Testing Programs |
| 20 | Programming Systems—General | 48 | Miscellaneous Programs |
| 21 | Assembler | 50 | Systems Techniques |
| 22 | APL | 60 | Application Programs |
| 23 | Basic | 61 | Type II Programs with Class "A" Maintenance |
| 24 | COBOL | 65 | Program Products - Applications |
| 25 | FORTRAN | 70 | Special Installation Services |
| | | 80 | Installation Supplies
Worksheets, Coding Forms, Physical Planning Templates |
| | | 85 | Reference Summaries
Formats, Capacities, Characteristics |
| | | 90 | Education Literature
Course Descriptions |
| | | 95 | Student Texts
Guides, Introductions, Illustrations |
| | | 99 | Other Supplementary Information
KWIC Index, Application Bibliographies |

Part 2—Publications Selector Charts

These charts are aids for quickly finding order numbers for System/360 and System/370 publications about a specific machine or programming system, except for those pertaining to the System/360 Model 20. The machine charts are arranged according to the numbers of the system models and the I/O devices. The programming charts are arranged to show prerequisite publications and categories of

publications for a particular system. To determine the models of System/360 and/or System/370 to which an I/O device currently may attach, see *IBM System/360 Input/Output Configurator*, GA22-6823, and *IBM System/370 Input/Output Configurator*, GA22-7002. See *IBM System/360 Model 20 Bibliography*, GA26-3565, for information about System/360 Model 20 machines and programming systems.

Machine System - System/360

Publication Description	Publication Order Number										
	Model 25	Model 30	Model 40	Model 44	Model 50	Model 65	Model 67	Model 75	Model 85	Model 91	Model 195
System Summary		GA22-6810 (for all models)									
System References		GA22-6821 (for all models)									
System Physical Planning Reference		GC22-6820 (for all models)									
Model Reference	GA24-3510	GA24-3231 (CPU) GA24-3411 (Channel)	GA22-6881	GA22-6875	GA22-6898	GA22-6884	GA27-2719	GA22-6889	GA22-6916	GA22-6907	GA22-6943
Model Configurator	GA24-3511	GA24-3232	GA22-6813	GA22-6874	GA22-6814	GA22-6887	GA27-2713	GA22-6888	GA22-6920	(in GA22-6907)	GA22-6944
Model Operating Procedures	GA24-3523	GA24-3373	GA22-6911	GA22-6910	GA22-6908	GA27-2728		GA22-6909	GA22-6927		GA22-6954
Model Physical Planning Template	GX22-6894	GX22-6894	GX22-6894	GX22-6914	GX22-6914	GX22-6856 GX22-6924	GX22-6905	GX22-6856	GX22-6923		GX22-6981
I/O Reference		See separate I/O chart.									
I/O Configurator		GA22-6823 (for all models)									
OEMI: Channel-to-Control Unit Interface		GA22-6843 (for all models)									
OEMI: Power Control Interface		GA22-6906 (for all models except 91)									
OEMI: Direct Control Feature		GA22-6845 (for all models except 44)									
Channel-to-Channel Adapter Feature		GA22-6892 (for all models)									
Other Features	GA24-3512 GA24-3524 GA24-3526	GA24-3255 GA24-3365 GC20-1650	GL22-6902 GL22-6903 GL22-6904	GA22-6900	GA27-2717	GA27-2715 GA27-2716 GA27-2717	GA27-2715		GA27-2733		

Machine System - System/370

Publication Description	Publication Order Number		
	Model 145	Model 155	Model 165
System Summary		GA22-7001 (for all models)	
System Reference		GA22-7000 (for all models)	
System Physical Planning Reference		GA22-7004 (for all models)	
Model Reference	GA24-3557	GA22-6942 (CPU) GA22-6962 (Channel)	GA22-6945
Model Configurator		GA22-6957	GA22-6956
Model Operating Procedures	GA24-3554		
Model Physical Planning Template	GX22-7005	GX22-7006	GX22-7007
I/O Reference		See separate I/O chart.	
I/O Configurator		GA22-7002 (for all models)	
OEMI: Channel-to-Control Unit Interface		GA22-6843 (for all models)	
OEMI: Power Control Interface		GA22-6906 (for all models)	
OEMI: Direct Control Feature		GA22-6845 (for all models)	
Other Features			GA22-6955 GA22-6958

Input/Output

I/O Device or Control Unit	Publication Order Number		
	Reference Manual	OEM Manual	Physical Planning Template
50 Magnetic Data Inscrber Model 1	GA27-2725		
1017 Paper Tape Reader Models 1, 2	GA33-4500		GX22-6834
1018 Paper Tape Punch Model 1	GA33-4500		GX22-6834
1051 Control Unit Models 1, N1	*	*	GX22-6894 GX24-3381
1052 Printer-Keyboard Models 3,5,8	*	*	
1052 Printer-Keyboard Model 7	GA22-6877		GX22-6894
1053 Printer Models 1,4	*	*	GX22-6894
1231 Optical Mark Page Reader Model N1	GA21-9031 (GA21-9012)		GX22-6860
1255 Magnetic Character Reader Models 1-3	GA24-3542		
1259 Magnetic Character Reader Model 2	GA24-3500		GX22-6860
1285 Optical Reader Model 1	GA24-3256		GX22-6860
1287 Optical Reader Models 1-4	GA21-9064		GX22-6860
1288 Optical Page Reader Model 1	GA21-9081		GX22-6860
1403 Printer Models 2,3,7,N1	GA24-3073 (GA24-3488)	GA24-1431	GX22-6834
1404 Printer Model 2	GA24-1446	GA24-3356	GX22-6834
1412 Magnetic Character Reader Model 1	GA24-1421		GX22-6860
1418 Optical Character Reader Models 1,2	GA24-1473 (GA24-1452) (GA24-3081)		GX22-6860
1418 Optical Character Reader Model 3	GA24-1473 GA24-3059 (GA24-1452) (GA24-3081)		GX22-6860
1419 Magnetic Character Reader Model 1	GA24-1499 (GA24-3342)		GX22-6860
1428 Alphameric Optical Reader Models 1,2	GA24-1473 (GA24-1452) (GA24-3081)		GX22-6860
1428 Alphameric Optical Reader Model 3	GA24-1473 GA24-3059 (GA24-1452) (GA24-3081)		GX22-6860
1442 Card Read Punch Model N1	GA21-9025		GX22-6834
1442 Card Punch Model N2	GA21-9025		GX22-6834
1443 Printer Model N1	GA24-3120 (GA24-3488)		GX22-6834
1445 Printer Model N1	GA24-3120		GX22-6834
1827 Data Control Unit Model 1	GA22-6868 (GA22-6872)		GX26-5508
2150 Console Model 1	GA22-6877		GX22-6859
2250 Display Unit Model 1	GA27-2701		GX22-6859
2250 Display Unit Model 3	GA27-2721		GX22-6859
2260 Display Station Models 1,2	GA27-2700 (GC20-1688)		GX22-6859
2285 Display Copier Model 1	GA27-2730		GX22-6859
2301 Drum Storage Model 1	GA22-6895 (GC20-1649)	GA26-5661	GX22-6858
2302 Disk Storage Models 3,4	GA26-5988 (GC20-1649)		GX22-6858
2303 Drum Storage Model 1	GA26-5988	GA26-5663	GX22-6858
2305 Fixed-Head Storage Models 1,2	GA26-1589		
2311 Disk Storage Drive Model 1	GA26-5988 (GC20-1649)	GA26-3567	GX22-6858

I/O Device or Control Unit	Publication Order Number		
	Reference Manual	OEM Manual	Physical Planning Template
2314 Direct Access Storage Facility Model 1, A Series, and B Series	GA26-3599 (GC20-1649)		GX22-6858
2321 Data Cell Drive Model 1	GA26-5988 (GA26-3633) (GC20-1649)	GA26-3674	GX22-6858
2401 Magnetic Tape Unit Models 1-6,8	GA22-6866	GA22-6862	GX22-6855
2415 Magnetic Tape Unit and Control Models 1-6	GA22-6866		GX22-6855
2420 Magnetic Tape Unit Model 5	GA32-0007		GX22-6855
2420 Magnetic Tape Unit Model 7	GA22-6918		GX22-6855
2495 Tape Cartridge Reader Model 1	GA27-2726		GX22-6855
2501 Card Reader Models B1,B2	GA21-9026		GX22-6834
2520 Card Read Punch Model B1	GA21-9027		GX22-6834
2520 Card Punch Models B2,B3	GA21-9027		GX22-6834
2540 Card Read Punch Model 1	GA21-9033		GX22-6834
2560 Multifunction Card Machine Model A1	GA26-5893		GX22-6894
2671 Paper Tape Reader Model 1	GA24-3388		GX22-6834
2701 Data Adapter Unit Model 1	GA22-6864	GA22-6844	GX22-6857
2702 Transmission Control Model 1	GA22-6848	GA27-3012	GX22-6857
2703 Transmission Control Model 1	GA27-2703	GA27-3012	GX22-6857
2803 Tape Control Models 1,2,3	GA22-6866		GX22-6855
2804 Tape Control Models 1,2,3	GA22-6866		GX22-6855
2816 Switching Unit Model 1	GA22-6866		GX22-6855
2820 Storage Control Model 1	GA22-6895		GX22-6858
2821 Control Unit Models 1-5	GA24-3312		GX22-6834
2822 Paper Tape Reader Control Model 1	GA24-3388		GX22-6834
2826 Paper Tape Control Models 1,2	GA33-4500		GX22-6834
2835 Storage Control Models 1,2	GA26-1589		
2840 Display Control Model 2	GA27-2721		GX22-6859
2841 Storage Control Model 1	GA26-5988		GX22-6858
2844 Auxiliary Storage Control Model 1	GA26-3599		GX22-6858
2848 Display Control Models 1-3,21,22	GA27-2700 (GC20-1688)		GX22-6859
3210 Console Printer-Keyboard Models 1,2	GA24-3552		GX22-7006
3211 Printer	GA24-3543		
3215 Console Printer-Keyboard Model 1	GA24-3550		GX22-7006
3330 Disk Storage Model 1	GA26-1592		
3420 Magnetic Tape Unit Models 3,5,7	GA32-0012		
3803 Tape Control Model 1	GA32-0012		
3811 Control Unit	GA24-3543		
3830 Storage Control Model 1	GA26-1592		
7770 Audio Response Unit Model 3	GA27-2712	GA27-2706	GX22-6857
7772 Audio Response Unit Model 3	GA27-2711 (GA27-2710)	GA27-2706	GX22-6857

Publications shown in parentheses are related but not primary references.
*See IBM SRL Bibliography Supplement — Teleprocessing, Order Number GA24-3089.

Basic Operating System

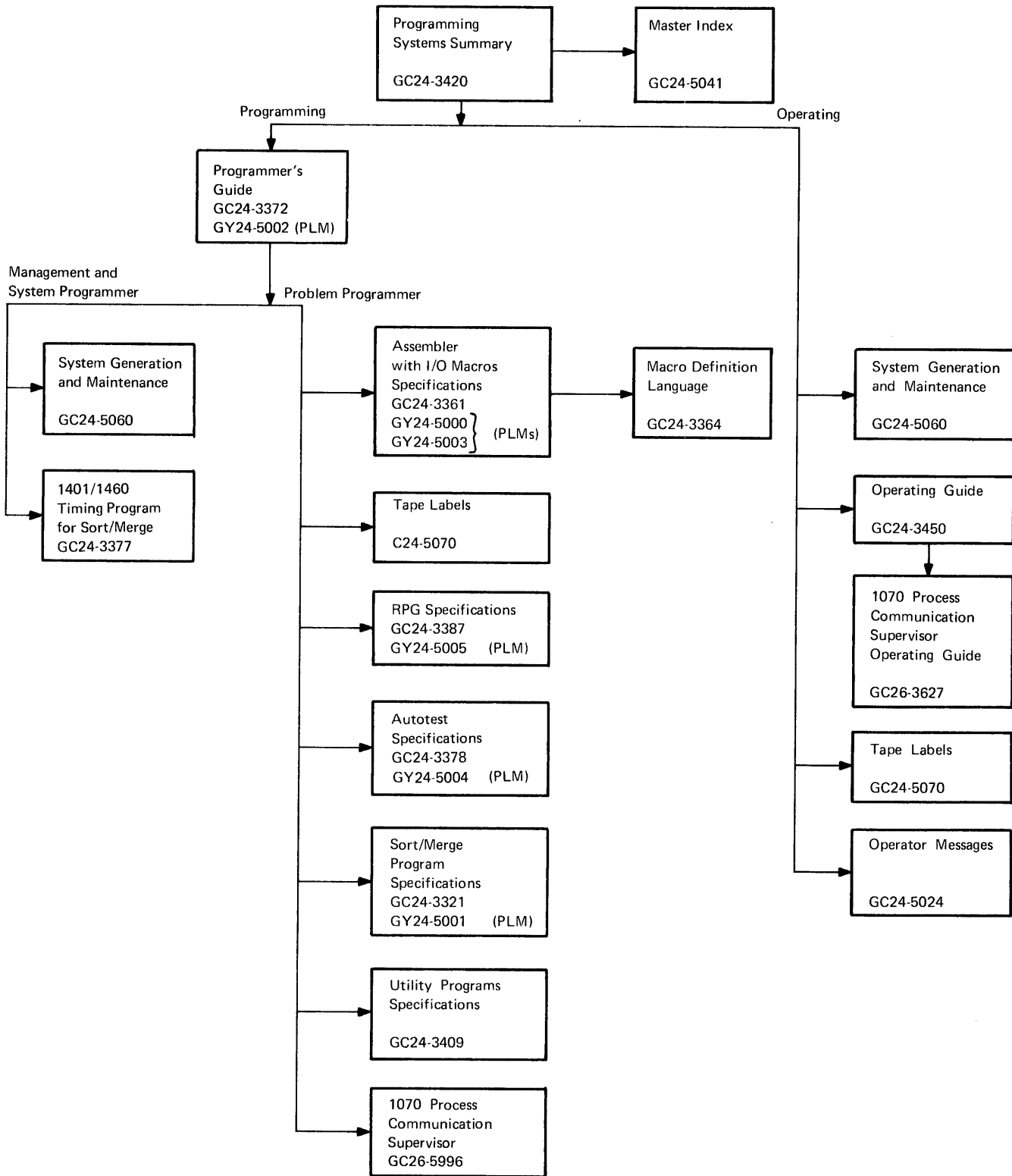

Basic Programming Support

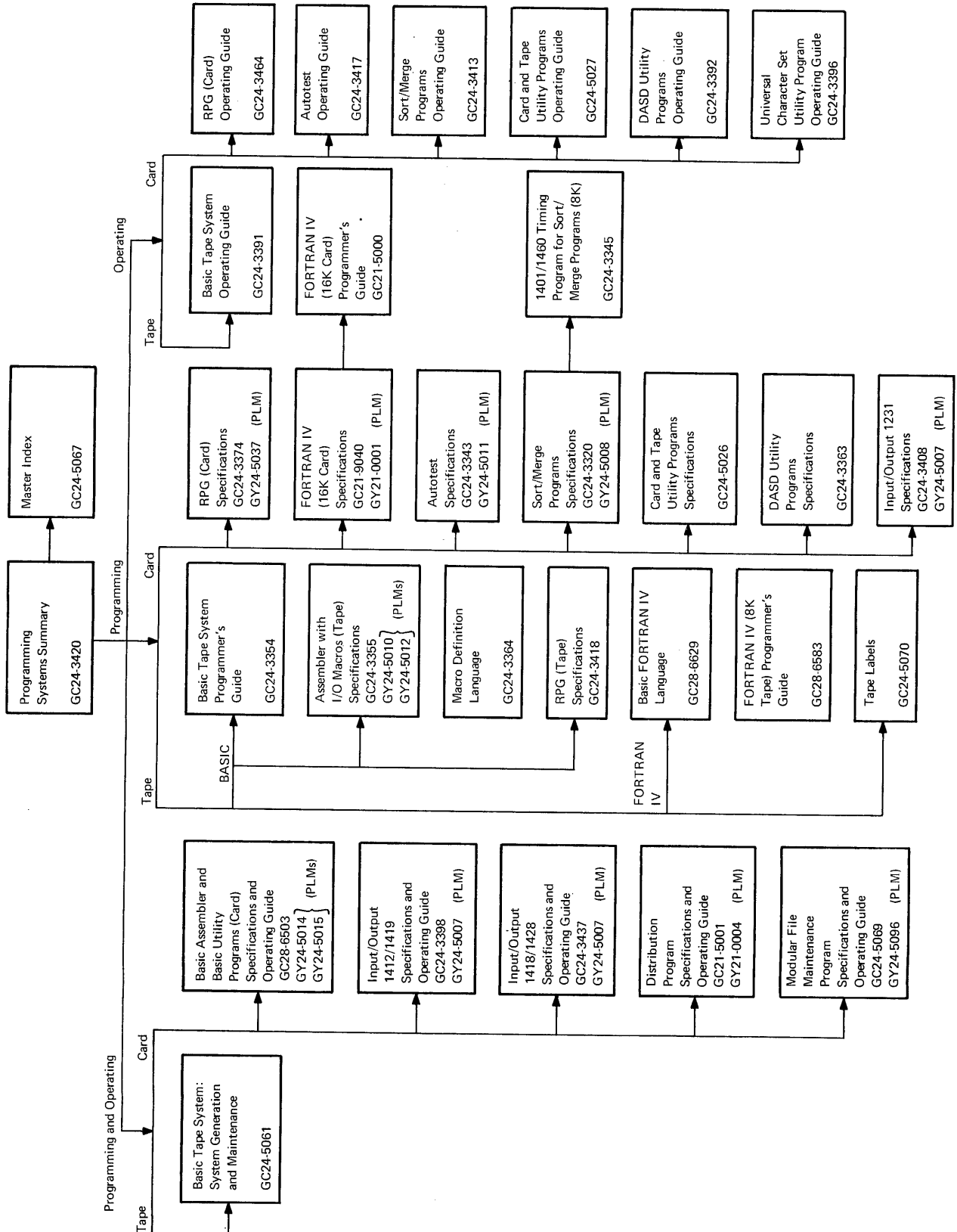

Tape Operating System

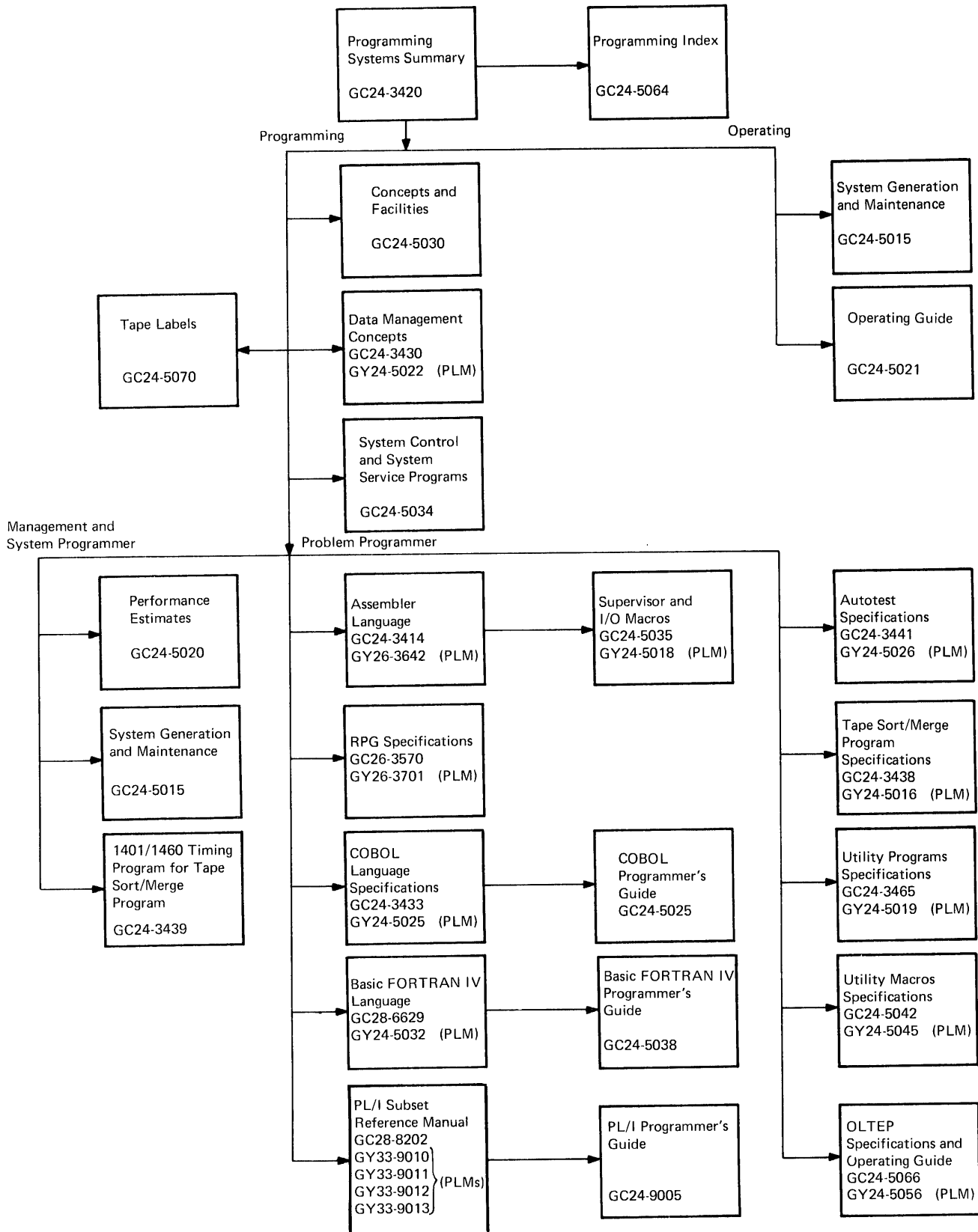

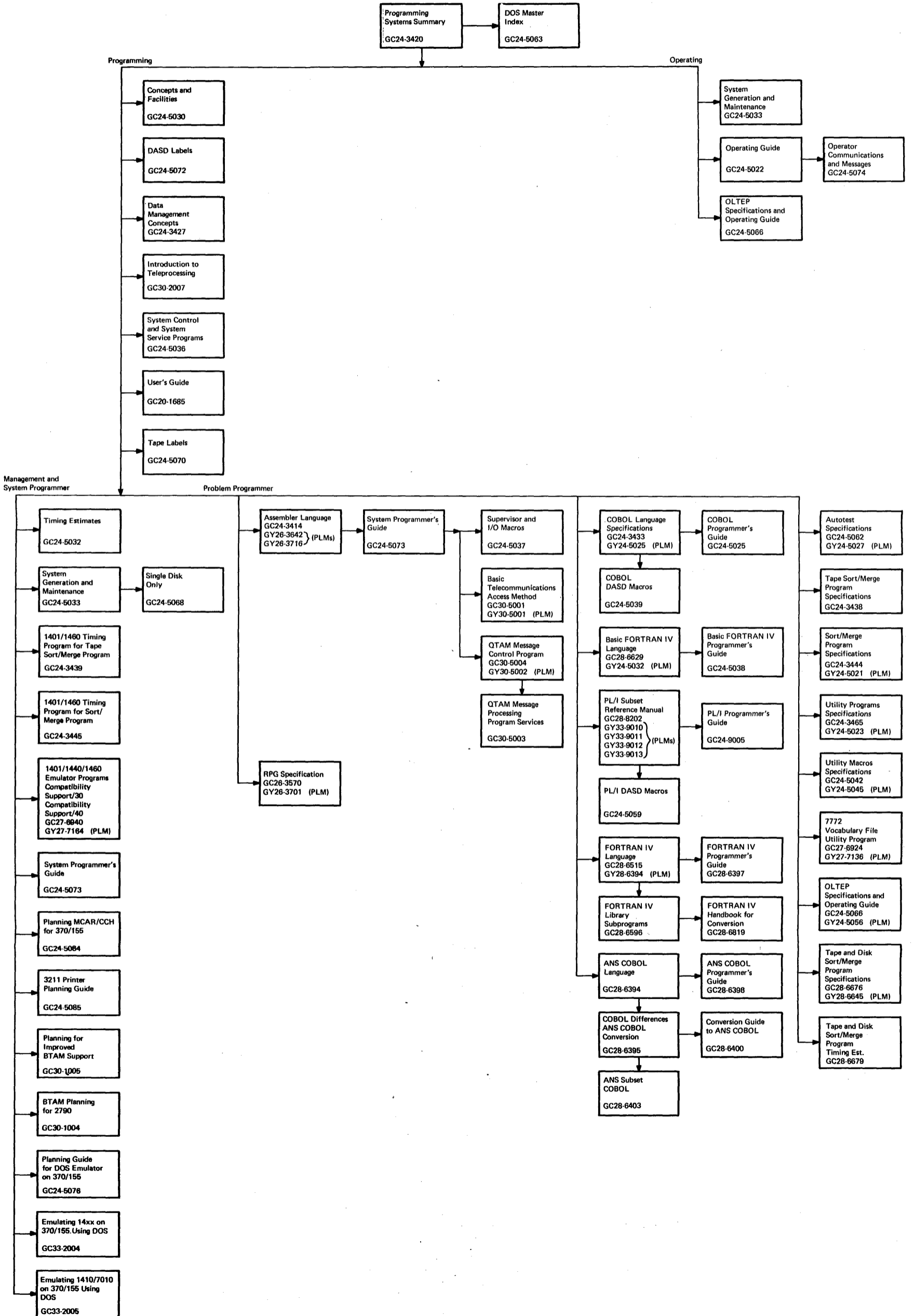

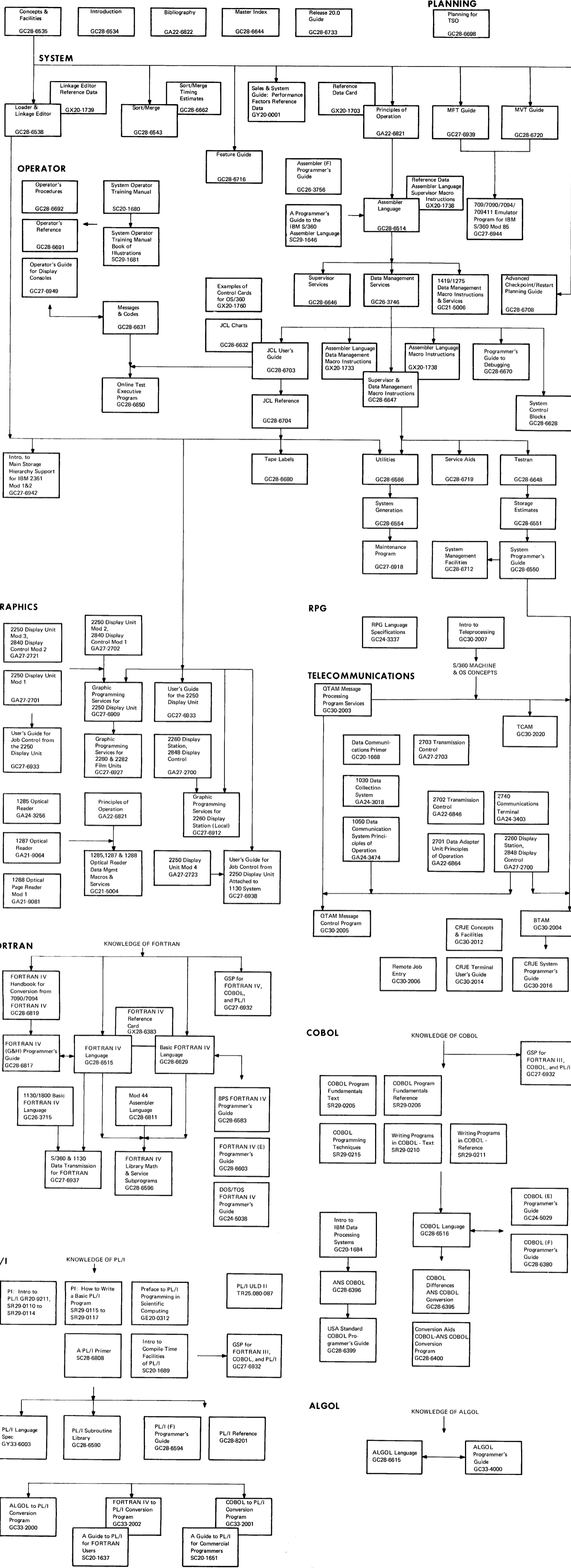

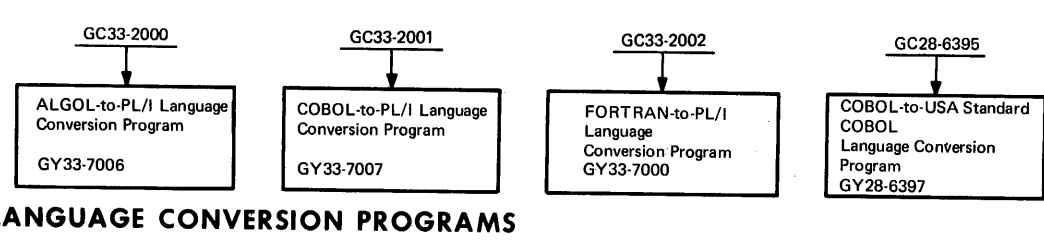
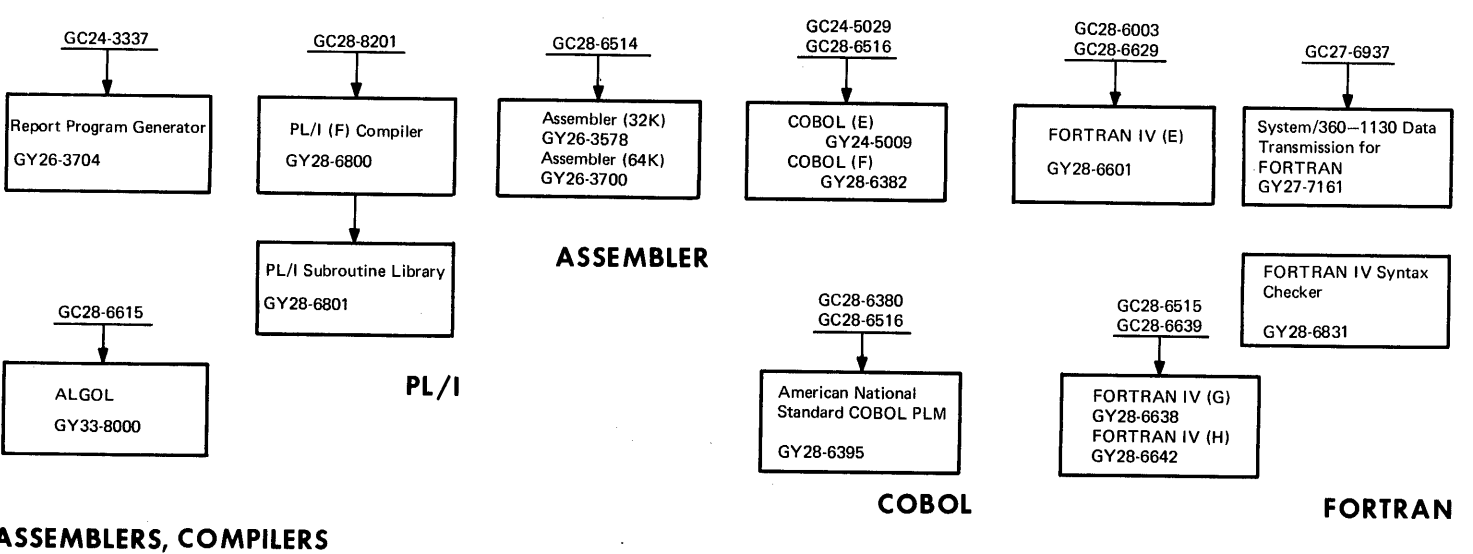
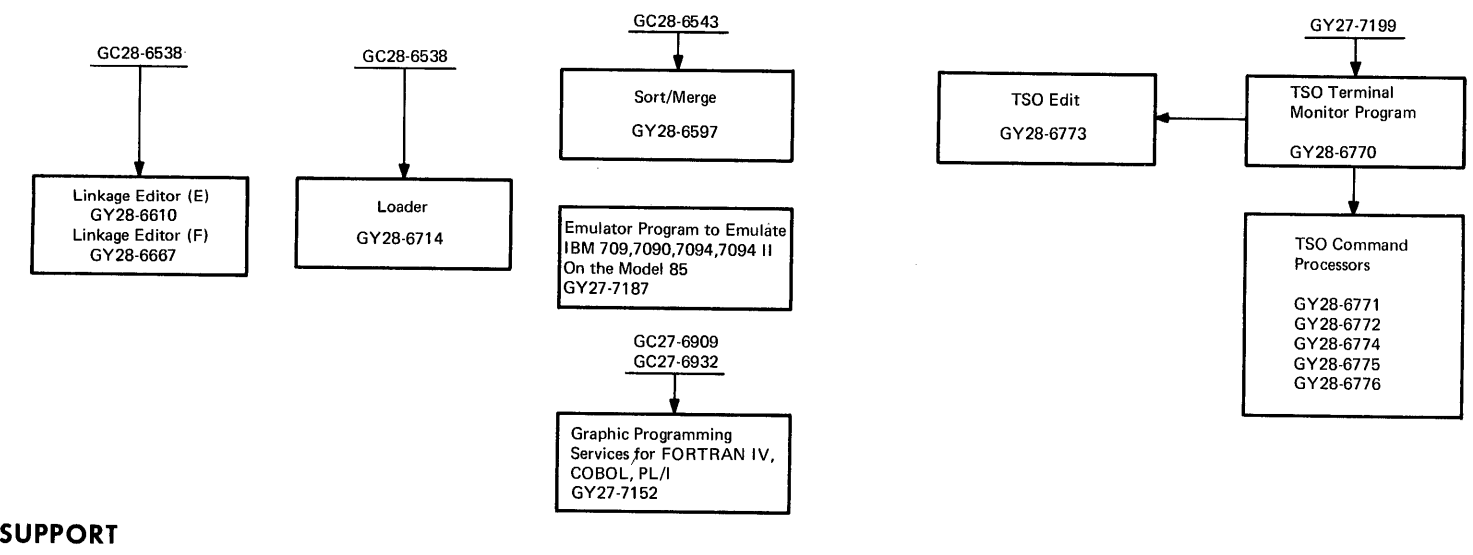
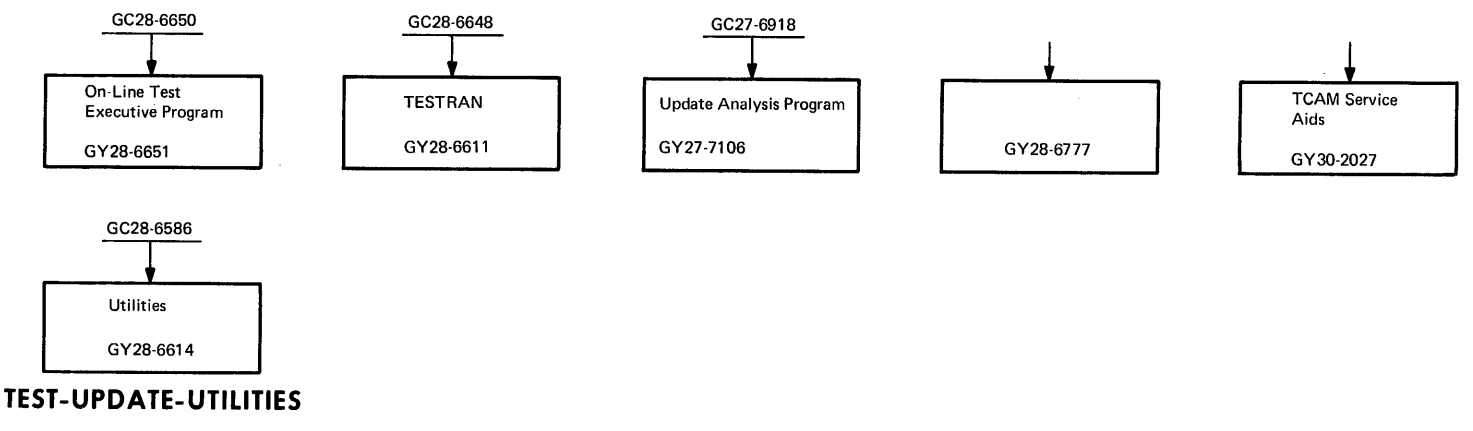
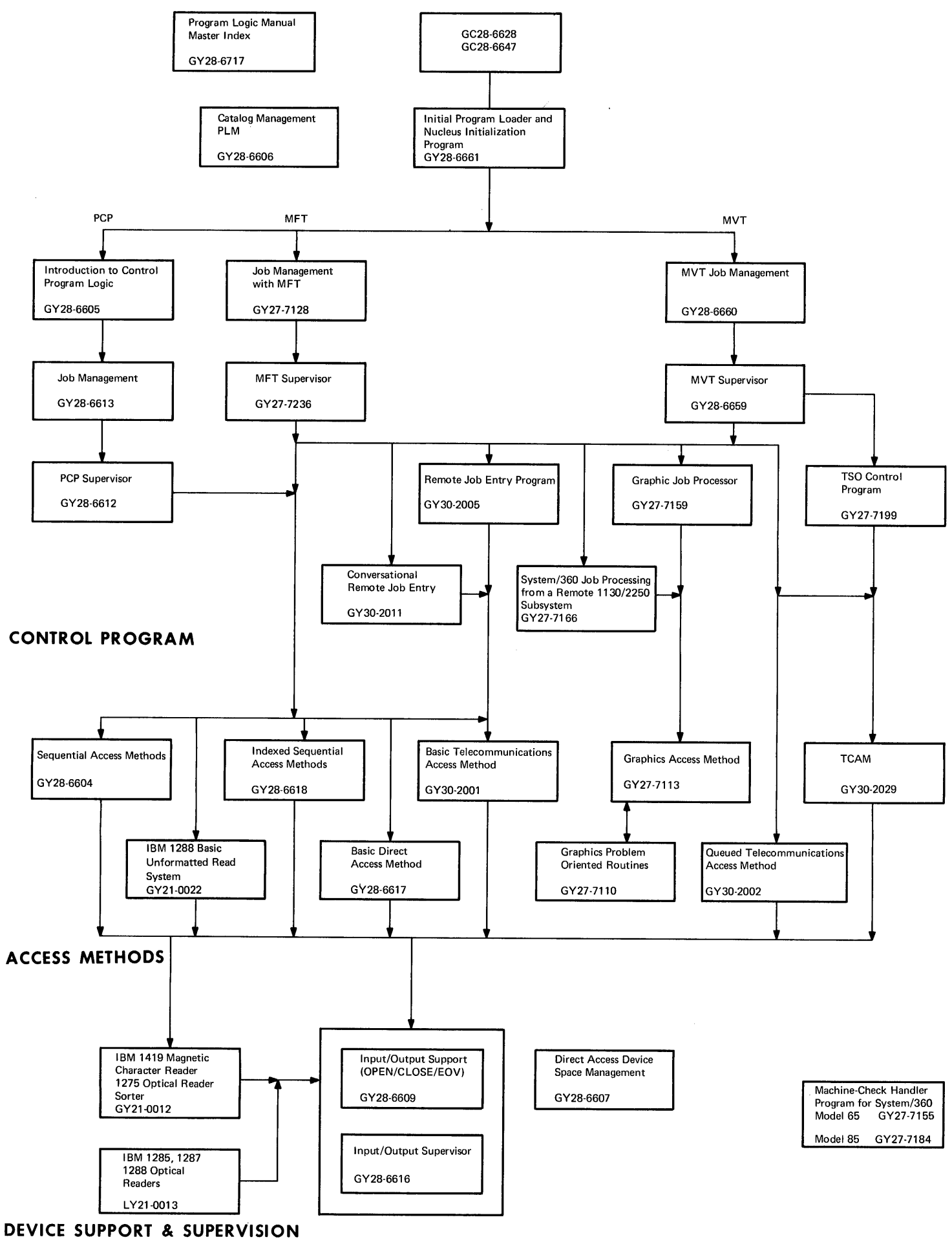

THIS PAGE INTENTIONALLY LEFT BLANK

Time Sharing System-SRLs

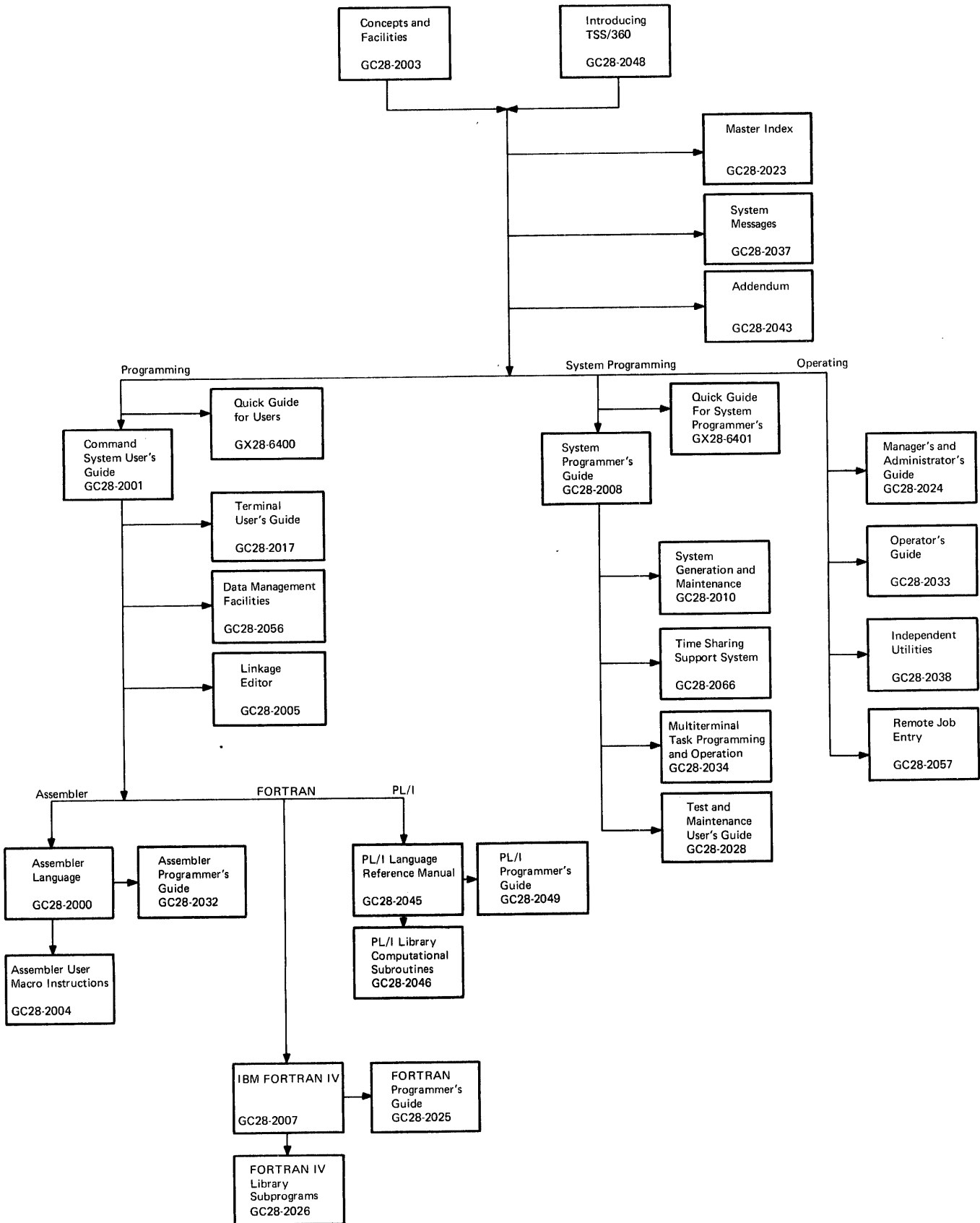

Time Sharing System-PLMs

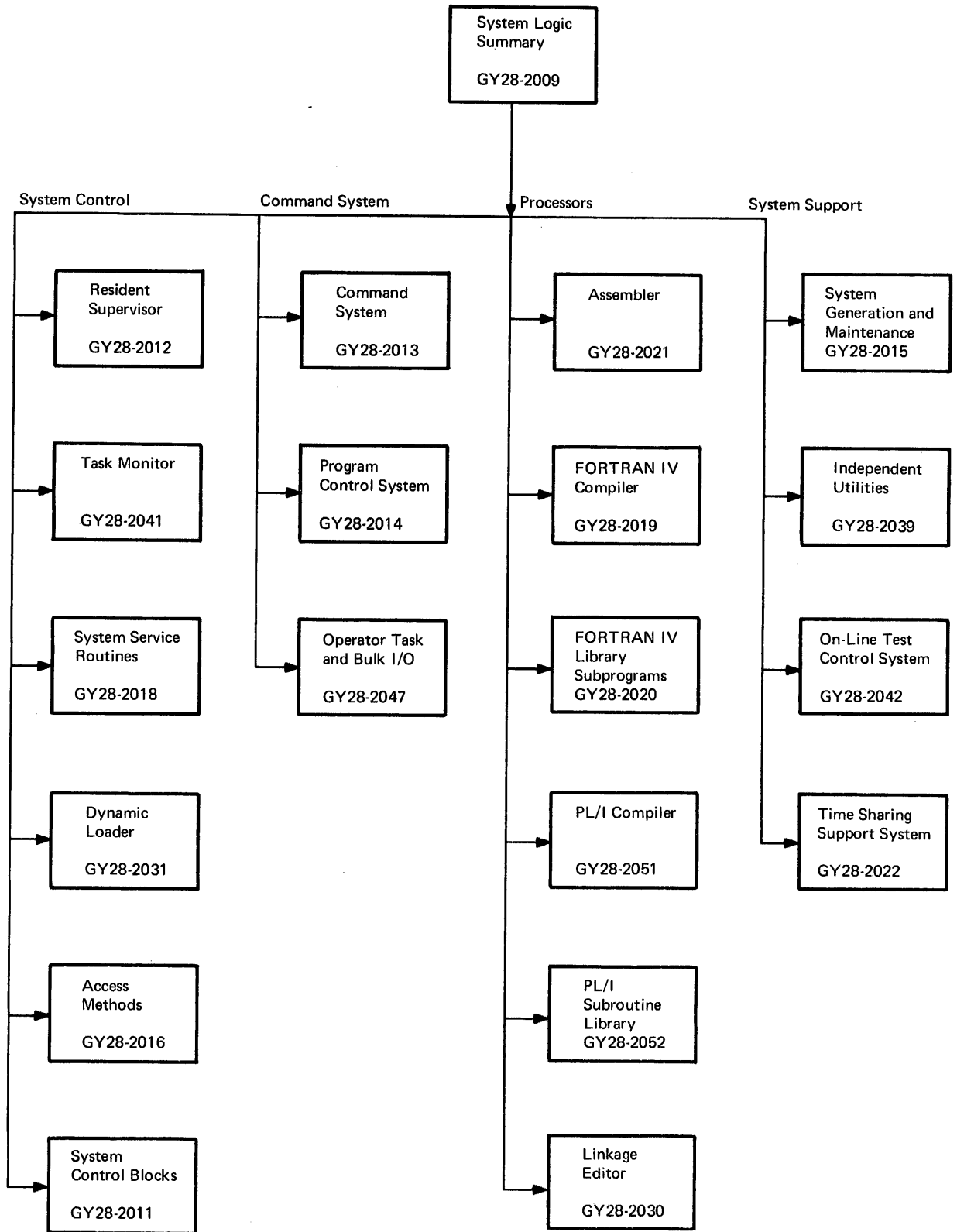

Part 3—Abstracts

The abstracts for all System/360 publications and materials, except those pertaining to the Model 20, are listed by order number. From the abstract, the System/360 user can determine if a particular publication is applicable. The subject code number is shown at the right of the title.

G229-3169 System/360 Operating 99
System — Handbook FE
Handbook

A handbook is a summary of basic maintenance documentation. It is the information on a system that the customer engineer requires at the system console to isolate a malfunction to a specific unit or function. The Handbook contains: general system reference data, including instruction formats; operation codes; code translation charts; interface information; error indication data; reference to diagnostic programs; etc. (198 pages)

G232-0001 IBM 2420 Model 7 Tape 05
Drive Operator's Guide Card

This reference guide card provides a convenient reference to the procedures for loading, unloading, and inserting the tape reel in cartridges. The procedures to follow for various problems are also included. (1 page)

G320-0956 ATS/360 Terminal 60
Operator's Quick
Reference Guide

This guide is intended to facilitate rapid instruction for the computer center operator using System/360 ATS/DOS. It is essentially based on information appearing in the ATS/DOS Computer Center Operator's Manual (GH20-0511).

This reference guide will be updated from time to time to reflect system changes and improvements; however, the reader should remember that the basic program documentations (which includes GH20-0511) is the authoritative source of the program information and will first reflect such changes. (76 pages)

G320-0958 ATS/360—DOS 60
Computer Operator's
Quick Reference Guide

This guide contains step-by-step procedure intended to facilitate rapid instruction of the computer center operator using System/360 Administrative Terminal System DOS (ATS/DOS). It is essentially based on information appearing in the ATS:DOS Computer Center Operator's Manual (GH20-0511). (39 pages)

G320-1002 ATS/360 — OS 60
Computer Operator's
Quick Reference Guide
Manual

This guide is intended to provide the computer center operator using System/360 ATS/OS with a quick reference to operational commands. It is not an instruction manual. The table of contents is organized by sequence of operations. An index is provided at the back of the guide. (40 pages)

GA19-0004 IBM 1219 Reader Sorter 03
Model 32 IBM 1419 Magnetic Character
Reader Model 32; For IBM World
Trade Use Only

This publication contains detailed information about the keys, lights, switches, mechanical features, and special features of the IBM 1219 Reader Sorter Model 32 and the IBM 1419 Magnetic Character Reader Model 32.

On-line and off-line data-flow and operating theory are fully discussed, with step-by-step procedures for each reader operation. Programming notes and error-correction routines are also covered in detail. It should be noted that, in the areas of on-line operation, error-recovery, and programming notes, this manual refers to the 1401 attachment only.

For additional information, readers are referred to the following publications: *IBM 1401/1460 Miscellaneous Input/Output Instructions*, Order Number GA24-3068; and *IBM 1419 Magnetic Character Reader with IBM 1410 System*, Order Number GA22-0536. For information concerning the attachment of the IBM 1219/1419 Model 32 to the IBM System/360 Models 30 or 40, readers are referred to *IBM 1419 Model 32 Attached to IBM System/360 Model 30 or 40*, Order Number GA19-0023. (60 pages)

GA19-0010 IBM 3944 Dial Terminal 09
Unit For World Trade Use Only

The IBM 3944 Dial Terminal Unit is designed to be used as an input device to Audio Response Units through a telephone network.

The IBM 7772 Audio Response Unit is an input/output unit of the IBM System/360 Models 30, 40, 50, 65, and 75, interfacing the computer and a telephone network. The Audio Response Unit provides, under program control, composed messages of spoken words in response to digital inquiries or input messages. Except for the use of digital language from the calling to the called line, communication between remote inquiry terminals and the Audio Response Unit is conducted in the same manner as an ordinary telephone call. (4 pages)

GA19-0019 IBM System/360 Model 13
30, 1401/1440/1460 Compatibility
Feature Inverted Print Edit and Sterling
Sub-Features

This publication is a supplement to the source manual entitled *IBM System/360 Model 30, 1401/1440/1460 Compatibility Feature*, Order Number GA24-3255, and should be read in conjunction with it. The information contained herein is intended primarily for users in World Trade sterling countries.

This publication is limited to a description of (1) the use of the Comma and Decimal Point Inversion Sub-Feature; and (2) how sterling-currency applications can be processed with the Sterling Currency Sub-Feature without conversion of existing 1400-series programs.

The reader is also referred to the *IBM System/360 Model 30, Functional Characteristics*, Order Number GA24-3231, for a description of the capabilities, functions, and operational characteristics of the System/360 Model 30; and to *Reference Manual, IBM 1401 Data Processing System Sterling Currency Features*, Order Number UK31401-0. (2 pages)

GA19-0023 IBM 1419 Model 32 03
Attached to IBM System/360 Model
25, 30, 40, 50, or 65 Systems
Reference Library Manual

This publication is a supplement to IBM 1219 Reader Sorter, Model 32—IBM 1419 Magnetic Character Reader, Model 32, Order Number GA19-0004 and should be read in conjunction with it.

This publication is limited to certain additions to GA19-0004. Additional operating information relating to Power On-Power Off, Channel Line Termination and Sort Mode Selection is provided.

GA19-0036 Paper and Print Quality 03
Requirements for IBM 1270 and 1275
Optical Reader Sorters

This publication describes the quality of paper and print required for documents that are to be read by the IBM 1270 and 1275 Optical Reader Sorters. The manual is intended for those responsible for providing the documents and for those who plan and maintain the optical character recognition system.

The following topics are dealt with:

1. The mechanical and optical characteristics desired of the paper.
2. The sizes and conditions of documents.
3. The quality of the printing, and the printing devices that can be used to obtain this quality.
4. The procedures for manual, as well as machine handling of the documents.

For information on the 1270 and 1275 Optical Reader Sorters, refer to Systems Reference Library (SRL) *IBM System/360 Component Description—IBM 1270 Optical Reader Sorter*, Order Number GA19-0035 and *IBM System/360 Component Description—IBM 1275 Optical Reader Sorter*, Order Number GA19-0034. For information on the design of documents, refer to *SRL Form-Design Considerations—System Printers*, Order Number GA24-3488.

For information on the IBM printing devices dealt with in the manual, refer to *SRL IBM 1403 Printer Component Description*, Order Number GA24-3073 and to the booklet *IBM Typing Instructions for Optical Character Recognition*. (38 pages)

GA19-0038 IBM System/370 15
Model 155 Installation Information
Physical Planning IBM World Trade
50-Hertz Requirements

This manual contains provisional physical information for installing the IBM System/370 Model 155, including floor planning and electrical, environmental, and structural requirements. It describes the physical characteristics of each unit and their effect on installation requirements.

This publication is intended for IBM World Trade usage by installation planners and it is assumed that the reader has a background knowledge of data processing equipment and installation planning techniques. (16 pages)

GA19-0039 IBM System/370 15
Model 165 Installation Information
Physical Planning IBM World Trade
50-Hertz Requirements

This manual contains provisional physical information for installing the IBM System/370 Model 165, including floor planning and electrical, environmental, and structural requirements. It describes the physical characteristics of each unit and their effect on installation requirements.

This publication is intended for IBM World Trade usage by installation planners and it is assumed that the reader has a background knowledge of data processing equipment and installation planning techniques. (24 pages)

GA21-9025 IBM 1442 N1 and N2 03
Component Description and Operating
Procedures

This publication describes the operating principles, machine features, and operating procedures of the IBM 1442 N1 Card Read Punch and the IBM 1442 N2 Card Punch. Also, it discusses in general the operation of these devices with IBM System/360.

For further information about these machines as they are used with System/360, refer to *IBM System/360 Principles of Operation*, Order Number GA22-6821, and other publications listed in *IBM System/360 Bibliography*, Order Number GA22-6822. (15 pages)

GA21-9026 IBM 2501 Models B1 03
and B2 Component Description and
Operating Procedures

This publication describes the operation of the IBM 2501 Card Reader Models B1 and B2 with IBM System/360 Models 30 and higher. Operating principles, system communication, and operating procedures are presented.

This manual assumes that the reader is familiar with the operation of the IBM System/360, as described in the SRL publication, *IBM System/360 Principles of Operation*, Order Number GA22-6821. (16 pages)

GA21-9027 IBM 2520—B1, B2, and 03
B3 Component Description and
Operating Procedures

This publication describes the IBM 2520 Card Read Punch Model B1 and the IBM 2520 Card Punch Models B2 and B3 with IBM System/360 Models 30 and above. Included are discussions of machine features and operating principles and procedures. (32 pages)

GA21-9031 IBM System/360 03
Component Description and Operating
Procedures: 1231-N1

This publication is a reference manual for the IBM 1231 Optical Mark Page Reader, which serves as an input device (reading handwritten marks from sheets of paper) for IBM System/360 Models 25, 30, 40, and 50. The manual provides reference information about the 1231-N1, explaining 1231-N1 operation and its interaction with the system to which it is attached.

The principle audience for this publication will be IBM System/360 programmers, system analysts, supervisors, and operators. Others who will use the manual are form designers, forms manufacturers, and input document printers.

Programmers, systems analysts, and supervisors using this manual will need to be familiar with the system to which the 1231-N1 is attached. For the form numbers and names of other publications describing the IBM System/360, see *IBM System/360 Bibliography*, Order Number GA22-6822. (40 pages)

GA21-9033 IBM System/360 Compo- 03
nent Description and Operating
Procedures IBM 2540 Card Read
Punch

This publication explains the operating principles, procedures, and controls of the IBM 2540 Card Read Punch. Special features for the 2540 are also discussed.

Refer to the *IBM 2821 Control Unit*, Form A24-3312, for information concerning the commands, status and sense indicators, and other programming considerations that affect the 2540. For similar information about an IBM 2540 attached to an IBM System/360 through the integrated 2540 attachment feature, refer to *IBM System/360 Model 25 Functional Characteristics*, Order Number GA24-3510

Additional information about the operation of the 2540 with various models of the System/360 is available in the appropriate System/360 operator's guides (see the *IBM System/360 Bibliography*, Order Number GA22-6822, for the order numbers of the required manual). (16 pages)

GA21-9050 IBM 2956 Optical Mark/ 03
Hole Reader Models 2 and 3 Com-
ponent Description and Operating
Procedures Systems Reference
Library Manual

This publication describes the IBM 2956 Optical Mark/Hole Reader and its operation with the IBM 2740 Communications Terminal. Included are descriptions of the 2956 operating principles, input forms design considerations, throughput timing, operator controls, and operating procedures.

Familiarity with 2740 operation, as described in the SRL manual, *IBM 2740 COMMUNICATIONS TERMINAL*, Order Number GA24-3403, is prerequisite to the use of this publication. (24 pages)

GA21-9064 IBM 1287 Optical 03
Reader Component Description and
Operating Procedures

This publication describes the IBM 1287 Optical Reader and its features, operating principles and procedures, and operations with IBM System/360. The manual also contains detailed specifications for input documents and tapes and for input data quality.

For other publications that describe IBM System/360, see the SRL manual *IBM System/360 Bibliography*, Order Number GA22-6822.

For more information about proper numeric handwriting for 1287 input, see *Handwriting Numbers and Symbols for the IBM Optical Reader*, Order Number SR29-1280, and the handwriting practice sheet, Order Number SR29-1281.F

For more detailed programming information, see one or more of these SRL manuals as appropriate:

IBM System/360 Basic Programming Support Specifications, Assembler with Input/Output Macros (8K Tape), Order Number GC24-3355.

IBM System/360 Basic Programming Support, Programmer's Guide (8K Tape), Order Number GC24-3354.

IBM System/360 Basic Operating System Specifications, Assembler with I/O Macros, Order Number GC24-3361.

IBM System/360 Basic Operating System Programmer's Guide, Order Number GC24-3372.

IBM System/360 Disk Operating System, Extended Supervisor and Input/Output Macros, Order Number GC24-5037.

IBM System/360 Disk Operating System, Data Management Concepts, Order Number GC24-3427.
IBM System/360 Tape Operating System, Extended Supervisor and Input/Output Macros, Order Number GC24-5035.
IBM System/360 Tape Operating System, Data Management Concepts, Order Number GC24-3430.
 (60 pages)

Programmers, systems analysts, and supervisors using this manual will need to be familiar with the system to which the 1288 is attached. For the form numbers and names of other publications describing the IBM System/360, see *IBM System/360 Bibliography*, Order Number GA22-6822. See *Handwriting Numbers and Symbols for the IBM Optical Reader*, Order Number SR29-1280 and the handwriting practice sheet, Order Number SR29-1281, for proper handwriting for 1288 input. (56 pages)

comprehensive description of the system structure; of the arithmetic, logical, branching, status switching, and input/output operations; and of the interruption system.
 The reader is assumed to have a basic knowledge of data processing systems and to have read the *IBM System/360 System Summary*, Order Number GA22-6810, which describes the system briefly and discusses the input/output devices available.
 For information about the characteristics, functions, and features of a specific System/360 model, use the functional characteristics manual for that model in conjunction with the *IBM System/360 Principles of Operation*. Descriptions of specific input/output devices used with the System/360 appear in separate publications. Publications that relate to the IBM System/360 Model 20 are described in the *IBM System/360 Model 20 Bibliography*, Order Number GA26-3565. (172 pages)

GA21-9070 IBM 1050 Special Features 13
Description—IBM ASCII Data Communication System with RPQ Features E18589, 82027, 842028 and 842029

This publication serves as a reference manual for the IBM 1050 ASCII Data Communication System, which provides the IBM System/360 Data Processing System with remote input and output capabilities using the American Standard Code for Information Interchange.
 Detailed information about the IBM System/360 and the appropriate transmission control unit will be found in their respective SRL publications. Site preparation information in the publication, *IBM 1050 Data Communication System Installation Manual, Physical Planning*, Order Number GA24-3022 applies for this system. For titles and abstracts of associated publications, see the *IBM Teleprocessing Bibliography*, Order Number GA24-3089 and the *IBM System/360 Bibliography*, Order Number GA22-6822. (52 pages)

GA22-6810 IBM System/360 00
System Summary

This publication provides basic information about the IBM System/360, with the objective of helping readers to achieve a general understanding of this new data processing system and the interrelationships of its models and parts. Broad system concepts, basic and optional features, and specific input/output devices are briefly discussed.
 It is assumed that the reader has a basic knowledge of data processing systems as in *Introduction to IBM Data Processing Systems*, Order Number GC20-1684.

This publication does not apply to System/360 Model 20. All Model 20 publications are listed in the *IBM System/360 Model 20 Bibliography*, Order Number GA26-3565.
 Detailed information on processing is in *IBM System/360 Principles of Operation*, Order Number GA22-6821. Description of programming systems and languages, as well as further details on the I/O devices and teleprocessing capabilities described herein, are in publications listed in the *IBM System/360 Bibliography*, Order Number GA22-6822 and *IBM Teleprocessing Bibliography*, Order Number GA24-3089. (120 pages)

GA22-6823 IBM System/360 Input/ 00
Output Configurator

This configurator deals with the input/output equipment available for the IBM System/360 Models 25-91.
 The presentation is arranged in two ways: by type of equipment (such as "direct access," "display," and "printers") and by machine number (such as 1052, 1403, and 7770). For each item of equipment, information is given concerning the way in which the item attaches to the system and the number of items that can be attached.
 Available System Reference Library (SRL) publications about individual items of I/O equipment are listed and described in the *IBM System/360 Bibliography*, Order Number GA22-6822. (6 pages)

GA21-9081 IBM System/360 Compo- 03
nent Description: IBM 1288 Optical Page Reader Model 1

This publication is a reference manual for the IBM 1288 Optical Page Reader, which serves as an input device for the IBM System/360 Models 25, 30, 40, and 50. This manual, which is organized by function, discusses:
 Interconnection between the 1288 and the processing unit.
 Characters read by the 1288 and their data codes.
 Data transfer between the 1288 and the system.
 Programming information about 1288 control, status signals, and sense indications.
 Optical mark data recording and reading.
 Operator controls for the 1288.
 Operating procedures for the 1288 that are not application dependent.
 Input document design and printing.
 Special features for the 1288.
 Input data printing.

The principle audience for this publication will be IBM System/360 programmers, system analysts, supervisors, and operators. Others who will use the manual are forms designers, forms manufacturers, and input document printers.

GA22-6813 IBM System/360 00
Model 40 Configurator

A schematic drawing shows the complete Model 40 processor with all standard and optional features. Input/output devices are shown on Order Number GA22-6823 and data communications devices on Order Number GA22-6824. (1 page)

GA22-6814 IBM System/360 00
Model 50 Configurator

A schematic drawing shows the complete Model 50 processor with all standard and optional features. Input/output devices are shown on Order Number GA22-6823 and data communications devices on Order Number GA22-6824. (1 page)

GA22-6824 IBM System/360 Data 00
Communications and Acquisition Configurator

This configurator presents the various possible configurations for the IBM 2701 Data Adapter Unit and the IBM 2702 Transmission Control. Examples are given of the adapters and machine features needed for specific configurations.
 Included are the following configurations:

	Page
Configurator for 2701 Low Speed Communication Lines	3
Configurator for 2701 Synchronous Communication Lines	5
Configurator for Combinations of 2701 Low Speed and Synchronous Communication Lines	7
Configurator for 2701 Data Acquisition	9
Configurator for Combinations of 2701 Data Acquisition and Communication Lines	11
Configurator for the IBM 2702	13
Configurator for a 2701/1030 System	15
Configurator for a 2702/1030 System	17
	(19 pages)

GA22-6821 IBM System/360 Principles 01
of Operation

This publication is the machine reference manual for the IBM System/360. It provides a direct,

GA22-6828 IBM 7340 Hypertape Drive Model 3 with IBM System/360 05

This publication describes the functions, operations, controls, and timings of the IBM 7340 Hypertape Drive Model 3, including the dynamics of 7340 reading and writing and details on the tape, tape cartridge, and optional automatic cartridge loader. In addition, all necessary details on the function and operation of the IBM 2802 Hypertape Control are presented.

This manual provides information for customer systems personnel and is designed as a reference and guide in the training of operators, system engineers, programmers, managers, and others who need a general idea of how Hypertape operates within the System/360. It is an I/O adjunct to *IBM System/360 Principles of Operation*, Order Number GA22-6821. (28 pages)

GA22-6843 IBM System/360 I/O Interface Channel to Control Unit—Original Equipment Manufacturers' Information 19

This Original Equipment Manufacturers' Information (OEMI) manual provides the definitions and functional descriptions of the interface lines for the IBM I/O Interface-Channel to Control Unit. In addition, it contains electrical, mechanical, and cabling considerations and specifications of this interface. (60 pages)

GA22-6844 IBM 2701 Data Adapter Unit Original Equipment Manufacturers' Information 18

This publication describes the IBM 2701 Data Adapter Unit interfaces. The processor interface description includes a description of the operating signals and responses. The transmission-adapter interface descriptions provide device-attachment information. The electrical, mechanical, and cabling specifications of these interfaces are provided, together with physical-planning requirements. (144 pages)

GA22-6845 IBM System/360 Direct Control and External Interrupt Features—Original Equipment Manufacturers' Information 19

This manual describes the specifications, timings, circuits and characteristics of the IBM System/360 Direct Control and External Interrupt features. The External Interrupt feature provides the means by which external devices may signal the CPU to gain its attention. The Direct Control feature includes the External Interrupt and provides an interface, exclusive of the channel, for the exchange of information between two central processing units, or between a central processing unit and external devices. (24 pages)

GA22-6846 IBM System/360 Component Description—IBM 2702 Transmission Control 05

This publication provides information concerning the operation of the IBM 2702 Transmission Control.

The first section contains a general description of the 2702, including the data communication terminals operable with the 2702, the terminal controls used by the 2702 to operate with the various terminals, and the data sets and communication facilities used.

The Operational Functions section discusses communication line addressing, 2702-multiplexor channel operation, and I/O instructions concerning the 2702. This section also contains the various commands and orders used by the 2702 and the transmit and receive operation sequences and, in addition, describes the functions of the status and sense bytes and the polling and addressing of the terminals. (32 pages)

GA22-6861 IBM 7340 Model 3 Hypertape Drive—Original Equipment Manufacturers' Information 19

The information in this manual is provided to assist designers of accessory equipment for IBM 7340 Model 3 Hypertape Drives. It includes all specifications, timing information, circuit descriptions, and cable information necessary for attaching a 7340-3 to a control unit. Additional details about the operation and maintenance of the 7340-3 may be obtained from the Customer Engineer's Manual of Instruction, the CE Reference Manual and the CE Maintenance Diagram Manual. (31 pages)

GA22-6862 IBM 2400-Series Magnetic Tape Units—Original Equipment Manufacturers' Information 19

This manual will assist designers of accessory equipment for IBM 2401, 2402 Models 1-6 Magnetic Tape Units, IBM 2403 Models 1-6 and 2404 Models 1-3 Magnetic Tape Units and Controls and IBM 2803/2804 Models 1 and 2 Tape Control Units.

Additional information about the operation and use of these tape units in integrated data processing systems can be obtained from the *IBM 2400 Magnetic Tape Units and 2816 Switching Unit Component Description*, Order Number GA22-6866, and from the local IBM Office. Information concerning I/O operations is in *IBM System/360 Channel to Control Unit OEMI*, Order Number GA22-6843. (46 pages)

GA22-6864 IBM 2701 Data Adapter Unit Principles of Operation 05

This manual provides information concerning the operation of the IBM 2701 Data Adapter Unit. The manual is divided into three sections.

The first section gives a general description of the 2701, including: the terminals operating with the 2701, the functional organization of the 2701, the special features on the 2701, and various configurations of the 2701.

The second section describes the operation of the 2701 with the System/360. Subjects discussed here include communication line addressing, multiplexor and selector channel operation, and I/O instructions concerning the 2701.

The third section covers the 2701's transmission adapters. A complete description on the operation of each adapter is made here. This description includes transmit and receive operation sequences, status and sense bytes, and the polling and addressing of the terminals. (48 pages)

GA22-6866 IBM System/360 Component Description—2400-Series Magnetic Tape Units, 2803/2804 Tape Controls, and 2816 Switching Unit, Model 1 05

This manual contains a comprehensive presentation of the characteristics, functions, and features of the IBM 2400-Series Magnetic Tape Units, 2803/2804 Tape Controls, and a general description of the IBM 2816 Model 1 Switching Unit. The 2400-series consists of the 2401, 2402, and 2420 Magnetic Tape Units, and 2403, 2404, and 2415 Magnetic Tape Units and Controls.

In most instances, operational descriptions are limited to the channel and command level. Operating functions and procedures common and fundamental to all I/O operations are described in *IBM System/360 Principles of Operation*, Order Number GA22-6821.

Subjects covered include magnetic tape unit principles; keys and lights; tape load, unload, and cleaning procedures; status and sense information; magnetic tape handling; tape block and reel organization; and error recovery procedures. (66 pages)

GA22-6868 IBM System/360 Component Description—IBM 1827 Data Control Unit 03

This publication contains the functional characteristics and operating information for the IBM 1827 Data Control Unit. Operations with the IBM System/360 Models 30, 40, 44, and 50 are described. The following IBM 1800 Data Acquisition and Control System Process I/O features are described: Digital Input, Digital Output, Analog Output, Analog Input, and Comparator. (40 pages)

GA22-6869 IBM 2361 Core Storage—OEMI 19

The information in this manual is provided to assist designers of accessory equipment for IBM 2361 Core Storage Model 1 and Model 2. It includes all specifications, timing information, circuit descriptions, and cable information necessary for attaching a 2361 to a system. Additional details about the operation and maintenance of the 2361 may be obtained from the local IBM Branch Office. (22 pages)

GA22-6872 1827 Data Control Unit 00
Configurator

A schematic drawing shows the attachment of IBM 1800 components to an IBM System/360. (1 folded page)

GA22-6874 IBM System/360 00
Model 44 Configurator

A schematic drawing shows the complete Model 44 processor with all standard and optional features. Input/output devices are shown on Order Number GA22-6823, and Data Communications Devices on Order Number GA22-6824. (1 page)

GA22-6875 IBM System/360 01
Model 44 Functional Characteristics

This manual describes the system structure, features, instruction timings and formulas, channels, device addressing, and operator controls unique to System/360 Model 44.

It is assumed the reader has a knowledge of the System/360 as defined in the *IBM System/360 Principles of Operation*, Order Number GA22-6821 and the *IBM System/360 System Summary*, Order Number GA22-6810.

For installations using the direct word, direct data channel, or priority interrupt features, a companion publication is *Data Acquisition Special Features for the IBM System/360 Model 44*, Order Number GA22-6900. Other related literature is described in *IBM System/360 Bibliography*, Order Number GA22-6822. (56 pages)

GA22-6877 IBM System/360 03
Component Descriptions and Operating Procedures IBM 1052 Printer-Keyboard Model 7 with IBM 2150 Console

This publication describes the functional and operational characteristics of the IBM 1052 Printer-Keyboard Model 7 with the IBM 2150 Console. (20 pages)

GA22-6881 IBM System/360 Model 40 01
Functional Characteristics

This manual presents the organization, characteristics, functions and features unique to the IBM System/360 Model 40. Major areas described are system structure, generalized information flow, standard and optional features, system control panel, instruction timings, and channel characteristics and functional evaluation.

Descriptions of specific input/output devices used with the IBM System/360 Model 40 appear in separate publications. Configurators for the IBM 2040 Processing Unit and I/O devices are available.

It is assumed that the reader has a knowledge of the System/360 as defined in the *IBM System/360 Principles of Operation*, Order Number GA22-6821 and the *IBM System/360 System Summary*, Order Number GA22-6810. (112 pages)

GA22-6884 IBM System/360 Model 65 01
Functional Characteristics

This manual presents the organization, characteristics, functions and features unique to the IBM System/360 Model 65. Major areas described are system structure, generalized information flow, standard and optional features, instruction timings, and the system control panel. (29 pages)

GA22-6887 System/360 Model 65 00
Configurator

A schematic drawing shows the complete Model 65 processor with all standard and optional features. Input/output devices are shown in Order Number GA22-6823, and Data Communications devices on Order Number GA22-6824. (1 page)

GA22-6888 IBM System/360 Model 75 00
Configurator

A schematic drawing shows the complete Model 75 processor with all standard and optional features. Input/output devices are shown on Order Number GA22-6823 and Data Communications devices on Order Number GA22-6824. (2 pages)

GA22-6889 IBM System/360 Model 75 01
Functional Characteristics

This manual presents the organization, characteristics, functions and features unique to the IBM System/360 Model 75. Major areas described are: system structure, generalized information flow, standard and optional features, instruction timings, and the system control panel.

Descriptions of specific input/output devices used with the IBM System/360 Model 75 appear in separate publications.

This manual assumes that the reader has a knowledge of System/360 as defined in the *IBM System/360 Principles of Operation*, Order Number GA22-6821 and the *IBM System/360 System Summary*, Order Number GA22-6810. (36 pages)

GA22-6892 IBM System/360 Special 13
Feature Channel-to-Channel Adapter

This manual describes the functions and operating characteristics of the channel-to-channel adapter in either multiple-processor or single-processor systems.

IBM System/360 input/output operations that are exclusive of device considerations are described in detail in the *IBM System/360 Principles of Operation*, Order Number GA22-6821. (16 pages)

GA22-6895 IBM System/360 07
Component Descriptions—2301 Drum Storage and 2820 Storage Control

This manual describes the operating characteristics of the IBM 2301 Drum Storage and the IBM 2820 Storage Control and discusses in detail the input/output operations performed by those units.

Input/output operations in the IBM System/360 that are exclusive of device considerations are described in detail in the *IBM System/360 Principles of Operation*, Order Number GA22-6821. (20 pages)

GA22-6898 IBM System/360 Model 50 01
Functional Characteristics

This manual presents the organization, characteristics, functions and features unique to the IBM System/360 Model 50. Major areas described are system structure, generalized information flow, standard and optional features, system control panel, instruction timings, channel characteristics, concurrent input/output capabilities, selector channel loading, multiplexer channel loading, and channel interference with the CPU.

Descriptions of specific input/output devices used with the IBM System/360 Model 50 appear in separate publications.

Configurators for the IBM 2050 Processing Unit and I/O devices are available. See *IBM System/360 Bibliography*, Order Number GA22-6822.

It is assumed that the reader has a knowledge of the System/360 as defined in the *IBM System/360 Principles of Operation*, Order Number GA22-6821 and the *IBM System Summary*, Order Number GA22-6810. (96 pages)

GA22-6900 Data Acquisition Special 13
Features for the IBM System/360 Model 44

This publication provides information about the operation, control, and interface of three special features:

- Direct Word
- Direct Data Channel
- Priority Interrupt

These features are particularly suitable for high-speed data acquisition and relatively complex control applications in the scientific fields.

Additional information can be found in *IBM System/360 Model 44 Functional Characteristics*, Order Number GA22-6875, and *IBM System/360 Principles of Operation*, Order Number GA22-6821. (26 pages)

GA22-6906 IBM System/360 Power 19
Control Interface—Original Equipment Manufacturers' Information

This Original Equipment Manufacturers' Information (OEMI) manual provides the definitions and descriptions of the power control interface lines. In addition, the manual contains the emergency power off operations and procedures. (10 pages)

GA22-6907 IBM System/360 Model 91 01
Functional Characteristics

This publication describes the organization and the functional characteristics of the IBM System/360 Model 91, an information-processing system designed for ultrahigh-speed, large-scale scientific and business applications.

The system components are described, and a detailed consideration is given to the functions of processor storage, the central processing unit, the input/output channels, and the operator-control and operator-intervention portions of the system control panel. In addition, certain coding and timing considerations are discussed.

The reader is assumed to have a knowledge of information-processing systems and to have read the *IBM System/360 Principles of Operation*, Order Number GA22-6821. (33 pages)

GA22-6908 IBM System/360 Model 50 01
Operating Procedures

The manual describes operator procedures for an IBM 2050 Processing Unit, operating with or without an associated IBM 1052 Printer-Keyboard. The manual describes machine functions, machine procedures, program-oriented procedures, and operator-intervention procedures. An appendix of reference material and an index are also included.

The reader should also refer to the following SRL publications:

IBM System/360 Principles of Operation, Order Number GA22-6821.

IBM System/360 Model 50 Functional Characteristics, Order Number GA22-6898.

IBM System/360 Tape Operating System Operating Guide, Order Number GC24-5021.

IBM System/360 Disk Operating System Operating Guide, Order Number GC24-5022.

IBM System/360 Operating System Operator's Guide, Order Number GC28-6540.

(Of the three operating system publications listed above, at least one applicable to the system in use should be read by the operator.)

For information pertaining to the operation of I/O units attachable to the System/360 Model 50, refer to the appropriate SRL publication. SRL publications that pertain to IBM System/360 and attachable units are abstracted and listed by order number in *IBM System/360 Bibliography*, Order Number GA22-6822. (96 pages)

GA22-6909 IBM System/360 Model 75 01
Operating Procedures

This manual describes operator procedures for an IBM 2075 Processing Unit, operating with or without an associated IBM 1052 Printer-Keyboard. The manual describes system control panel machine functions, machine procedures, program-oriented procedures, and operator-intervention procedures. An appendix of reference material and an index are included.

The reader is assumed to have a knowledge of the following SRL publications:

IBM System/360 Principles of Operation, Order Number GA22-6821 (sections on "System Structure" and "System Control Panel").

IBM System/360 Model 75 Functional Characteristics, Order Number GA22-6889.

IBM System/360 Tape Operating System Operating Guide, Order Number GC24-5021.

IBM System/360 Disk Operating System Operating Guide, Order Number GC24-5022.

IBM System/360 Operating System Operator's Guide, Order Number GC28-6540.

For information pertaining to the operation of I/O units that are attachable to the System/360 Model 75, refer to the appropriate SRL publication. All System/360 SRL publications that pertain to IBM System/360 and attachable units are abstracted and referenced by order number in *IBM System/360 Bibliography*, Order Number GA22-6822. (39 pages)

GA22-6910 IBM System/360 Model 44 01
Operating Procedures

This manual describes operator procedures for an IBM 2044 Processing Unit, operating with its associated Console Printer-Keyboard. The manual has sections devoted to system control panel machine functions, machine procedures, program-oriented procedures, operator-intervention procedures, and command examples, plus an appendix of reference material, and a complete index.

The reader should also refer to the following SRL publications:

IBM System/360 Principles of Operation, Order Number GA22-6821 (sections on System Structure and System Control Panel).

IBM System/360 Model 44 Functional Characteristics, Order Number GA22-6875.

IBM System/360 Model 44 Programming System, Guide to System Use, Order Number GC28-6812.

IBM System/360 Model 44 Programming System Operator's Guide, Order Number GC28-6815

For information pertaining to the special features for this model, refer to *Data Acquisition Special Features for the IBM System/360 Model 44*, Order Number GA22-6900. For information pertaining to operation of the I/O units attachable to System/360 Model 44, refer to the appropriate SRL publication. All System/360 SRL publications are abstracted and listed by order number in *IBM System/360 Bibliography*, Order Number GA22-6822. (68 pages)

GA22-6911 IBM System/360 Model 40 01
Operating Procedures

This manual describes operator procedures for an IBM 2040 Processing Unit, operating with or without an associated IBM 1052 Printer-Keyboard. The manual has sections devoted to system control panel functions, system procedures, program-oriented procedures, operator-intervention procedures, and command examples, plus an appendix of reference material, and a complete index.

The reader is assumed to have a knowledge of the following SRL publications:

IBM System/360 Principles of Operation, Order Number GA22-6821 (sections on "System Structure" and "System Control Panel").

IBM System/360 Model 40 Functional Characteristics, Order Number GA22-6881.

IBM System/360 Tape Operating System Operating Guide, Order Number GC24-5021.

IBM System/360 Disk Operating System Operating Guide, Order Number GC24-5022.

IBM System/360 Operating System Operator's Guide, Order Number GC28-6540.

(Of the three operating system publications listed above, at least one applicable to the system in use should be read by the operator.)

For information pertaining to operation of the I/O units that are attachable to the System/360 Model 40, refer to the appropriate SRL publication. All System/360 SRL publications are abstracted and listed by order number in *IBM System/360 Bibliography*, Order Number GA22-6822. (84 pages)

GA22-6916 IBM System/360 Model 85 01
Functional Characteristics

This publication describes the organization and the functional characteristics of the IBM System/360 Model 85, an information-processing system designed for very high-speed, large-scale scientific and business applications.

The system components are described, and a detailed consideration is given to the functions of processor storage, the central processing unit, the input/output channels, and the operator-control and operator-intervention portions of the system control panel. In addition, certain coding and timing considerations are described.

The reader is assumed to have a knowledge of information-processing systems and to have read the *IBM System/360 Principles of Operation*, Order Number GA22-6821. Other related literature is referenced by order number and briefly described in *IBM System/360 Bibliography*, Order Number GA22-6822. (40 pages)

GA22-6920 IBM System/360 Model 85 00
Configurator

A schematic drawing showing the complete Model 85 processor with all standard and optional features. Input/output control units and devices are shown on the *IBM System/360 I/O Configurator*, Order Number GA22-6823. (2 pages)

GA22-6935 IBM System/370 Model 01
165 Functional Characteristics

This publication describes the organization and the functional characteristics of the IBM System/370 Model 165, an information-processing system designed for very high-speed, large-scale scientific and business applications.

The system components are described, and a detailed consideration is given to the functions of processor storage, the central processing unit, the input/output channels, and the operator-control and operator-intervention portions of the system control panel. In addition, certain coding and timing considerations are described.

The reader is assumed to have a knowledge of information-processing systems and to have an understanding of the System/360, as that system is described in the *IBM System/360 Principles of Operation*, Order No. GA22-6821. The *IBM System/370 Principles of Operation*, GA22-7000, should be used in conjunction with the *IBM System/360 Principles of Operation*. (48 pages)

GA22-6942 IBM System/370 Model 01
155 Functional Characteristics

This publication describes the organization, functional characteristics, and features of the IBM System/370 Model 155. System components are described, and consideration is given to the central processing unit, main storage, input/output channels, and the operator control and operator intervention portions of the system control panel.

This publication is intended for users and potential users of the Model 155. The reader is assumed to have a background knowledge of data processing systems. (48 pages)

GA22-6951 0050 Magnetic Data 10
Inscriber Operator's Guide Manual

This manual for the IBM 50 Magnetic Data Inscribe (MDI) has been prepared to satisfy the requirements of the operator. It contains descriptions, in text and illustrations, of all the possible operations. Included are a general description of the machine and its capabilities, procedures for readying the machine, and detailed descriptions of operations, recovery procedures, specific applications, special features, and available accessories. (129 pages)

GA22-6954 IBM System/360 Model 01
195 Operating Procedures

This manual describes operator procedures for an IBM System/360 Model 195, operating with or without an associated IBM 1052 Printer-Keyboard. The manual describes the system control panel, system procedures, program-oriented procedures, operator-intervention procedures, and IPL procedures. An appendix of reference material and an index are also included. This manual is intended for the Model 195 system operator.

The reader is assumed to have a knowledge of information-processing systems and to have read the *IBM System/360 Operating System, Operator's Guide*. Order Number GC28-6540. (88 pages)

GA22-6956 IBM System/360 Model 00
165 Configurator

Diagram of 3165 Processing Unit and attachable channels (no I/O units) showing capacities and all standard and special features. (2 pages)

GA22-6957 IBM System/360 Model 00
155 Configurator

This sheet shows standard and optional features, main storage sizes by model, channel and sub-channel availability by model, and adapters required for console I/O units on the System/370 Model 155. (1 page)

GA22-6962 IBM System/370 Model 01
155 Channel Characteristics

This publication describes methods used to calculate System/370 Model 155 data handling capabilities that are dependent upon I/O-channel configurations and operations. Considerations of methods are also presented for:

1. Priority attachment of I/O devices for maximum throughput.
2. Calculating interference (with the processing unit) caused by channel operations.

Information related to specific I/O devices is contained in separate Systems Reference Library publications. These publications are listed by order number and briefly described in *IBM System/360 Bibliography*, GA22-6822.

This manual is intended for users at the system programmer level; it assumes a thorough background in I/O programming techniques. (52 pages)

GA22-6970 IBM System/370 Model 15
155 Installation Information
Physical Planning

This manual contains provisional physical information for installing the IBM System/370 Model 155, including floor planning and electrical, environmental, and structural requirements. It describes the physical characteristics of each unit and their effect on installation requirements.

This publication is intended for use by installation planners and it is assumed that the reader has a background knowledge of data processing equipment and installation planning techniques. (16 pages)

GA22-6971 IBM System/370 Model 15
165 Installation Information
Physical Planning

This manual contains provisional physical information for installing the IBM System/370 Model 165, including floor planning and electrical, environmental, and structural requirements. It describes the physical characteristics of each unit and their effect on installation requirements.

This publication is intended for use by installation planners and it is assumed that the reader has a background knowledge of data processing equipment and installation planning techniques. (28 pages)

GA22-7000-0 IBM System/370 01
Principles of Operation

The IBM System/370 is a data processing system that is based on the IBM System/360 but that extends the capabilities of that system. This manual describes extensions to the functional design of the System/360 that are incorporated in models of the System/370.

The reader is assumed to have an understanding of the System/360, as described in the *IBM System/360 Principles of Operation*, GA22-6821. The *System/370 Principles of Operation* should be used in conjunction with the *System/360 Principles of Operation*.

For information about the characteristics, functions, and features of a specific System/370 model, use the functional characteristics manual for that model. (32 pages)

GA22-7001 IBM System/370 System 00
Summary

This publication is intended to provide basic information about IBM System/370, the data processing system based on IBM System/360 but extending beyond the capabilities of that system. The objective of this publication is to help readers achieve a general understanding of this data processing system and of the interrelationships of its components. Briefly discussed are the system concepts, features, individual models, programming systems, and attachable input/output devices of System/370.

A basic knowledge of data processing systems, such as that given in the *Introduction to IBM Data Processing Systems*, GC20-1684, is assumed.

More detailed information about System/370 is available in *IBM System/370 Principles of Operation*, GA22-7000, and the associated publication, *IBM System/360 Principles of Operation*, GA22-6821. For more information about any individual System/370 model, see the functional characteristics manual for that model. (120 pages)

GA22-7002 System/370 Input/Output 00
Configuration

This document highlights all of the Input/Output devices that can be configured on the System/370. (8 pages)

GA22-1421 1412 Magnetic Character 03
Reader Model 1

Describes the features and functions of the IBM 1412 Magnetic Character Reader Model 1. Explains in detail its operating principles, including document feeding, reading, and distribution, as well as control of both on-line and off-line operations. A section on operating procedures is included.

Programming notes and an explanation of 1401 stored program instructions used to control 1412 operations are presented.

Explains the use and operation of four special features: Multiple Columns Select-Sort Suppress Feature, Auxiliary Document Counter, Self-Checking Number Verification, and Electronic-Accumulator and Sequence-Checking Feature. (56 pages)

GA24-1431 IBM 1403 Printer—OEMI 19

This manual contains information that will assist non-IBM engineers to attach the IBM 1403 Printer to their equipment. It includes a general description of machine functions and a reference listing of publications and engineering documents. It also contains information concerning machine interface not readily available in other publications. Charts of signal connectors and power plug pin assignments are included. (16 pages)

GA24-1446 IBM 1404 Printer 03

The IBM 1404 Printer, an output unit for the IBM 1401 Data Processing System and the IBM System/360, Models 30, 40, and 50, is capable of printing either cut-card forms or continuous forms. This reference publication presents the functional and operational characteristics of the 1404, including the settings of the feed mechanism and the print unit. It also describes the read-compare special feature. Information on timing and on certain normal operating procedures is presented. (24 pages)

**GA24-1452 Print Quality Considerations 03
IBM 1418 and IBM 1428**

This publication contains a detailed description of the print quality requirements of printing to be read by the IBM 1418 Optical Character Reader and the IBM 1428 Alphameric Optical Reader and to be used as input to an IBM 1401 Data Processing System, IBM 1460 Data Processing System, and IBM System/360 Model 30. The use of print-quality measuring devices is fully explained with examples of the range of acceptable printing produced by the IBM 407 Accounting Machine, IBM 1403 Printer, IBM Selectric® Typewriter and IBM Electric Typewriter.

Refer to *IBM 1401/1460 Bibliography*, Order Number GA24-1495, for other publications. (44 pages)

**GA24-1473 IBM 1418 Optical Character 03
Reader—IBM 1428 Alphameric
Optical Reader**

This publication describes the operation of the IBM 1418 Optical Character Reader and the IBM 1428 Alphameric Optical Reader used as input devices to an IBM 1401 Data Processing System.

Included are a description of character and mark-reading capabilities, off-line sorting, document-design requirements, and examples of the range of acceptable print quality of the documents to be scanned by both machines. The use of the IBM 1418/1428 Document Design and PDS Timing Chart and the formulas for calculating document output and maximum character reading per document are also fully discussed as an aid in optimizing the design of documents to be read by both machines. (44 pages)

**GA24-1499 IBM 1219 Reader Sorter, 03
IBM 1419 Magnetic Character
Reader**

This publication describes the operating characteristics, controls, indicators, and features of the IBM 1219 Reader Sorter and the IBM 1419 Magnetic Character Reader. Operating theory and procedures are given for off-line operation of both machines and on-line operation of the IBM 1419 within the 1400 series and System/360 systems.

Document handling and data flow are discussed fully, and step-by-step procedures and practical examples are given for each machine. Programming notes and error recovery procedures are also given.

For additional publication information, refer to the Bibliography for the system to which the IBM 1419 is attached. (96 pages)

**GA24-3073 IBM 1403 Printer Com- 03
ponent Description**

This reference publication describes the various models of the IBM 1403 Printer used with IBM 1401, 1410, 1440, 1460, 7010, 7040, 7044, and System/360 Models 20, 25, 30, 40, 50, 65, and 75 Data Processing Systems.

The functional and operating characteristics of the printer are presented.

The special features available for the 1403 are included, and timing information is given for printing and paper movement. (56 pages)

**GA24-3081 Mark Read Station 13
(Slanted Mark) for IBM 1418 and
IBM 1428**

This publication describes the Mark Read Station (Slanted Mark) special feature. This feature is available for the IBM 1418 Optical Character Reader Models 1 and 2; and for the IBM 1428 Alphameric Optical Reader Models 1 and 2. A description of these functional specifications is included:

- Document Specifications
- Mark Reading
- Document Format
- Document Corner Cuts
- Document Feeding

The Slanted Mark Reading Gage is also fully described.

This publication is for those familiar with programming and operating the IBM 1418 and 1428 Models 1 and 2, as described in these Systems

Reference Library publications:

- Programming for the IBM 1418 and IBM 1428 Optical Readers*, Order Number GC24-1091.
- IBM 1418 Optical Character Reader and IBM 1428 Alphameric Optical Reader*, Order Number GA24-1473.

(16 pages)

**GA24-3089 IBM SRL Bibliography 00
Supplement—Teleprocessing**

This bibliography lists the available reference literature for installing, programming, and operating IBM

teleprocessing equipment, used independently or with several data processing systems. For publications on data communications equipment and programs associated with a single data processing system, see the bibliography for that system.

Part 1 lists publications by major subjects. This sequence (subject code) may be used in building a library.

Part 2 is a cross-index of tele-processing equipment with the associated data processing system.

Part 3 contains abstracts of tele-processing publications in form-number sequence. Copies of most form-numbered publications may be ordered through the local IBM Sales Representative. (20 pages)

**GA24-3120 IBM 1443 Printer Models 03
1 to 4 and N1—IBM 1445 Printer
Models 1 and N1**

This reference publication describes the operation of the IBM 1443 and 1445 Printers with the IBM 1240, 1401, 1440, 1450, 1460, 1800, and certain models of the IBM System/360 Data Processing System.

It also discusses timing information for the printer and the tape-controlled carriage as well as their functional and operating characteristics. The speed of the printer using the various character sets is also described.

Included is command, status, and sense information pertaining to the printers used with IBM System/360 Data Processing Systems.

For a list of other publications and abstracts, see the IBM bibliography for the associated data processing system. (32 pages)

**GA24-3231 IBM System/360 Model 30 01
Functional Characteristics**

This reference publication describes the relationship of the IBM System/360 Model 30 to the entire System/360. The system's capabilities, features, I/O channels, and operations are also discussed.

The reader can find a more detailed description of the System/360 operations in *IBM System/360 Principles of Operation*, Order Number GA22-6821. The interrelationships of the models and units available with System/360 are broadly described in *IBM/360 System Summary*, Order Number GA22-6810. Other related literature is listed by order number and briefly described in *IBM System/360 Bibliography*, Order Number GA22-6822.

Information on channel load limits for IBM System/360 Model 30 is given in *IBM System/360 Model 30 Channel Characteristics and Functional Evaluation*, Order Number GA24-3411. (72 pages)

**GA24-3232 IBM System/360 Model 30 00
Configurator**

A schematic drawing shows the complete Model 30 processor with all standard and optional features. Input/output devices are shown on Order Number GA22-6823 and data communications devices on Order Number GA22-6824. (1 page)

GA24-3255 IBM System/360 Model 30 13
1401/1440/1460 Compatibility Feature

This publication describes the 1401/1440/1460 Basic Compatibility feature and associated subfeatures for the System/360 Model 30. These special features enable a rapid and simplified transfer from 1401-, 1440-, or 1460-oriented applications to the IBM System/360 Model 30.

Refer to the *IBM System/360 Model 30 Functional Characteristics*, Order Number GA24-3231, for description of the capabilities, functions, and operational characteristics of the System/360 Model 30.

The *IBM System/360 Bibliography*, Order Number GA22-6822, lists the associated reference publications. (124 pages)

GA24-3256 IBM 1285 Optical Reader 03
Component Description and Operating Procedures

This publication describes the IBM 1285 Optical Reader. The major topics include operating principles, controls and operating procedures, programming for the IBM System/360, and input tape and printing specifications. For more information about the operation of the 1285 with a particular system, see the appropriate SRL bibliography:

IBM System/360 Bibliography, Order Number GA22-6822.

IBM 1401/1460 Data Processing Systems Bibliography, Order Number GA24-1495.

IBM 1440 Data Processing System Bibliography, Order Number GA24-3005. (36 pages)

GA24-3312 IBM 2821 Control Unit 03

This reference publication presents a description of input/output operations controlled through the IBM 2821 Control Unit. The IBM 2540 Card Read-Punch and the IBM 1403 and 1404 Printers controlled by the IBM 2821 Control Unit are briefly described. Commands, status, and sense information pertaining to the attached input/output units is presented. Programming timing considerations for control unit, card reader, card punch, and printers are also presented.

For further information about the attached input/output units, refer to *IBM 2540 Card Read-Punch*, Order Number GA21-9033, *IBM 1403 Printer*, Order Number GA24-3073, and *IBM 1404 Printer*, Order Number GA24-1446. For further information about input/output and channel operations, refer to *IBM System/360 Principles of Operation*, Order Number GA22-6821. Other related literature is listed in *IBM System/360 Bibliography*, Order Number GA22-6822. (76 pages)

GA24-3342 Batch Numbering Feature 13
for IBM 1241 and 1419 Magnetic Ink Character Recognition Readers

This publication describes the functions and features of the Batch Numbering special feature when used with the IBM 1241 Magnetic Ink Character Recognition Reader and the IBM 1419 Magnetic Character Reader.

The operation of the keys, lights, and switches, as well as the programming information needed to operate the feature, is covered in detail. (14 pages)

GA24-3356 IBM 1404 Printer 19
Model 2—OEMI

This reference manual contains information that will assist non-IBM engineers to attach their equipment to the IBM 1404 Printer Model 2. It contains a general description of machine functions, a reference listing of publications and engineering documents, and information concerning machine interface not readily available in other publications. For titles and abstracts of associated publications, see the *IBM 1401 and 1460 Bibliography*, Order Number GA24-1495. (20 pages)

GA24-3365 IBM System/360 Model 30 13
1620 Compatibility Feature

This publication describes the IBM 1620 Compatibility Feature for the IBM System/360 Model 30. This special feature provides a means of rapid and simplified transfer of 1620-oriented applications to the IBM System/360 Model 30.

Refer to *IBM System/360 Model 30 Functional Characteristics*, Order Number GA24-3231, for a description of the capabilities, functions, and operating characteristics of the System/360 Model 30.

The *IBM System/360 Bibliography*, Order Number GA22-6822, lists associated reference publications. (76 pages)

GA24-3373 IBM System/360 Model 30 01
Operator's Guide

This reference publication describes operator procedures for the IBM 2030 Processing Unit and for the IBM 1050 Documentary Console (attached to the IBM System/360 Model 30). For additional information pertaining to operation of the I/O units attachable to System/360 Model 30, refer to the appropriate Systems Reference Library publication. Systems Reference Library publications that pertain to IBM System/360 and attachable I/O units are abstracted and referenced by order number in *IBM System/360 Bibliography*, Order Number GA22-6822. (39 pages)

GA24-3388 IBM 2671 Paper Tape Reader 03
IBM 2822 Paper Tape Reader Control

This reference publication describes the operation of the IBM 2671 Paper Tape Reader and the IBM 2822 Paper Tape Reader Control when used as input to the IBM System/360 Models 30, 40, 44, 50 and 67. The System/360 channel commands necessary to control the operation of the 2671 Paper Tape Reader are fully described.

Console controls, tape specifications, tape splicing procedures, tape loading procedures, and special features available for the 2671 are also described.

Titles and abstracts of associated publications are listed in the *IBM System/360 Bibliography*, Order Number GA22-6822. (42 pages)

GA24-3411 IBM System/360 Model 30 01
Channel Characteristics and Functional Evaluation

This reference publication describes methods used to calculate System/360 Model 30 data handling capabilities that are dependent upon I/O-channel configurations and operations. Consideration of methods are also presented for:

1. Priority attachment of I/O units for maximum throughput,
2. Addressing I/O units,
3. Calculating buffer transfer times,
4. Calculating interference (with the processing unit) caused by channel operations.

Calculations for a System/360 Model 30 with a 1.5-microsecond Read/Write (RW) cycle and with a 2-microsecond RW cycle are discussed separately.

The user of this publication should be thoroughly familiar with I/O programming considerations as described in *IBM System/360 Principles of Operation*, Form A22-6821. Information related to specific I/O devices is contained in separate Systems Reference Library publications. These publications are listed by form number and briefly described in *IBM System/360 Bibliography*, Order Number GA22-6822.

When you are performing loading calculations related to the multiplexor channel operating in multiplex mode, use the *IBM System/360 Model 30 Multiplexor Channel Worksheet*, Order Number GX24-3407. If the IBM 2702 Communications Control is used in your configuration, use the *IBM System/360 Model 30 2702 Worksheet*, Order Number GX24-3406. (75 pages)

GA24-3426 IBM 2712 Remote 09
Multiplexor

This reference publication describes the IBM 2712 Remote Multiplexor and its operation. The 2712 is used with IBM 1050, 1060, 2740, and 2741 Terminals (134.49 baud) and with telegraph terminals (74.2 baud) connected to IBM System/360 through the IBM 2702 and 2703 Transmission Control Units. Communication facilities that can be used with the 2712 are specified. (8 pages)

GA24-3488 IBM 1403, 1443 and 2203 03
Printers Form-Design Considerations

This publication contains information that should be considered by personnel designing, ordering, or using forms for the IBM 1403, the IBM 1443, or the IBM 2203 Printer. (16 pages)

- GA24-3500 IBM 1259 Magnetic Character Reader—Component Description** 03
- This reference publication contains information about all the features and functions of the IBM 1259 Magnetic Character reader. On-line and off-line data flow and operating theory are discussed, with detailed programming information and operating instructions for each reader function.
- Refer to the following bibliographies for additional publications:
- IBM System/360 Model 20 Bibliography*, Order Number GA26-3565
- IBM System/360 Bibliography*, Order Number GA22-6822
- IBM 1440, 1240, and 1450 Bibliography*, Order Number GA24-3005 (40 pages)
- GA24-3509 IBM 2944 Data Channel Repeater Installation Manual—Physical Planning** 15
- This publication provides physical planning information for the IBM 2944 Data Channel Repeater Models 1 and 2 when used with the IBM System/360. Included are physical specifications and cable, electrical, and environmental requirements.
- For a list of related publications and abstracts, see the *IBM System/360 Bibliography*, Order Number GA22-6822. (8 pages)
- GA24-3510 IBM System/360 Model 25 Functional Characteristics** 01
- This reference publication augments the *IBM System/360 Principles of Operation*, Form A22-6821. It describes the relationship of the Model 25 to other System/360 models: system capabilities, system control panel, input/output channels and integrated I/O attachments, operations, instruction timings, and system features.
- The reader should have a knowledge of the System/360 as defined in the *IBM System/360 Principles of Operation*, Order Number GA22-6821.
- Other IBM publications relating to the Model 25 are:
- IBM System/360 Bibliography*, Order Number GA22-6822.
- IBM System/360 System Summary*, Order Number GA22-6810.
- IBM System/360 Model 25 Configurator*, Order Number GA24-3511.
- IBM System/360 Input/Output Configurator*, Order Number GA22-6823.
- IBM System/360 Model 25 Operator's Guide*, Order Number GA24-3523.
- IBM System/360 Model 25, 1401/1460 and 1440 Compatibility Features*, Order Number GA24-3512.
- IBM System/360 Model 25, Model 20 Mode Feature*, Order Number GA24-3524.
- IBM System/360 Model 25, Integrated Communications Attachment Feature*, Order Number GA24-3526. (156 pages)
- GA24-3511 IBM System/360 Model 25 Configurator** 00
- A schematic drawing showing the complete Model 25 processor with all standard and optional features. Input/output devices are shown on Order Number GA22-6823, and data communications devices are shown on Order Number GA22-6824. (1 page)
- GA24-3512 IBM System/360 Model 25 IBM 1401/1460 and 1440 Compatibility Features** 13
- This publication describes the 1401/1460 and 1440 Compatibility features for the System/360 Model 25. These special features enable a rapid and simplified transfer from 1401-, 1460-, or 1440-oriented applications to the IBM System/360 Model 25.
- Refer to the *IBM System/360 Model 25 Functional Characteristics*, Order Number GA24-3510, for a description of the capabilities, functions and operational characteristics of the System/360 Model 25.
- The *IBM System/360 Bibliography*, Order Number GA22-6822, lists the associated reference publications. (48 pages)
- GA24-3516 IBM 2938 Array Processor Model 1 RPQ W24563, Model 2 RPQ 815188; Installation Manual—Physical Planning** 15
- This publication contains physical planning information for installing the IBM 2938 Array Processor Models 1 and 2 (RPQ). Included are dimensions, weights, electrical requirements, and environmental specifications. A cable diagram and a cable requirements chart are provided.
- For further system information and for explanation of symbols, see *IBM System/360 Installation Manual—Physical Planning*, Order Number GC22-6820. (6 pages)
- GA24-3519 IBM System/360 Custom Equipment Description: 2938 Array Processor Model 1, RPQ W24563 Model 2, RPQ 815188** 13
- The IBM 2938 Array Processor is an auxiliary computing unit for System/360 Models 44, 65, 67--1, and 75. It performs high-speed processing of arrays of data using short-precision floating-point arithmetic. This publication describes the principles of operation and functional characteristics of the Array Processor.
- A prerequisite for studying this bulletin is a basic knowledge of the IBM System/360 as contained in the *IBM System/360 Principles of Operation*, Order Number GA22-6821. (60 pages)
- GA24-3523 IBM System/360 Model 25 Operating Procedures** 01
- This reference publication describes the operating features and procedures for units of the IBM System/360 Data Processing System Model 25. Included are procedures for starting, initializing, storing, altering, displaying, and restarting the:
- 2025 Processing Unit
 - 1052 Printer-Keyboard Model 7
 - 2540 Card Read Punch
 - 2311 Disk Storage Drive Model 1
 - 1403 Printer Model 2 or 7
- For additional information on particular units and special features, refer to appropriate publications listed in *IBM System/360 Bibliography*, Order Number GA22-6822. (76 pages)
- GA24-3524 IBM System/360 Model 25 Model 20 Mode Feature** 13
- This reference publication describes the characteristics, implementation, and operating considerations for the IBM System/360 Model 20 Mode Feature for the System/360 Model 25.
- Other IBM publications necessary for a complete understanding of this feature are:
- IBM System/360 Model 20 Functional Characteristics*, Order Number GA26-5847.
- IBM System/360 Model 25 Functional Characteristics*, Order Number GA24-3510.
- The publications applicable to the System/360 Model 20 are listed in the *IBM System/360 Model 20 Bibliography*, Order Number GA26-3565.
- The publications applicable to the System/360 Model 25 are listed in the *IBM System/360 Bibliography*, Order Number GA22-6822. (20 pages)
- GA24-3526 IBM System/360 Model 25 Integrated Communications Attachment Feature** 13
- This reference publication describes the operation of the Integrated Communications Attachment feature for the IBM System/360 Model 25. Included is a general description of the feature and its common controls. Also included are the communications facilities that can be used with the Integrated Communications Attachment (ICA) and the remote terminals and processors that may be serviced by the ICA. Configuration limitations, overrun considerations, and the effects on multiplexer channel data rates are also presented.
- The reader should have a knowledge of System/360 as defined in the SRL publications:
- IBM System/360 Principles of Operation*, Order Number GA22-6821.
- IBM System/360 Model 25 Functional Characteristics*, Order Number GA24-3510.
- For a list of other associated System/360 publications, see the *IBM System/360 Bibliography*, Order Number GA22-6822. (20 pages)

GA24-3538 IBM System/360 Model 25 01
Channel Characteristics and
Functional Evaluation

This reference publication describes methods used to calculate IBM System/360 Model 25 data-handling capabilities that are dependent upon I/O-channel configurations and operations. Also presented are considerations of methods for:

1. Priority attachment of I/O units for maximum throughput.
2. Addressing I/O units.
3. Calculating buffer transfer times.
4. Calculating interference (with the processing unit) caused by channel operations.

Calculations for an IBM System/360 Model 25 with a selector interface and with a multiplexer interface are discussed separately. When performing loading calculations related to the multiplexer channel operating in multiplex mode, use the *IBM System/360 Model 25 Channel 0 (Multiplexer Channel) Load Work Sheet*, Order Number GX24-3541. This work sheet is used for Configuration A, on the front side, and Configuration B, on the reverse side.

The user of this publication should be thoroughly familiar with I/O programming considerations as described in *IBM System/360 Principles of Operation*, Order Number GA22-6821. Information related to specific I/O devices is contained in separate Systems Reference Library publications. These publications are listed by form number and briefly described in *IBM System/360 Bibliography*, Order Number GA22-6822. (52 pages)

GA24-3543 IBM 3211 Printer and 03
3811 Control Unit Component
Description

This reference publication describes the 3211 Printer and the 3811 Control Unit used on input/output channels provided by processing systems. The manual is designed for those having a basic knowledge of programming and computer operation.

Described are the features, speeds (including formulas), type arrays, carriage operations, suggested error-recovery procedures, programming and operating information, and the IBM 3216 Interchangeable Train Cartridge. The programming information includes details of storage areas, addressing, and the commands and coding for each operation.

For additional information, refer to the Bibliography of the system to which the 3211 Printer is attached.

For additional specifications on forms, refer to the Systems Reference Library Manual, *Form-Design Considerations-System Printers*, GA24-3488. (36 pages)

GA24-3545 IBM 2956-5 Multi-Pocket 15
Reader Sorter Installation Manual—
Physical Planning

This publication provides physical planning information for the IBM 2956-5 Multi-Pocket Reader Sorter when used with the IBM System/360 Models 30, 40, and 50. Included are physical specifications and cable, electrical, and environmental requirements.

For a list of related publications and abstracts, see the *IBM System/360 Bibliography*, GA22-6822. (8 pages)

GA24-3547 IBM System/360 Model 13
25 High-Speed Channel-2314 At-
achment Feature RPO E69109

This publication describes the operation of the 2314 attachment feature used with the IBM System/360 Model 25. Programming and operating information is provided in the form of instruction timing, error indications, and CPU indicators as applicable to high-speed channel operation.

The reader should have a knowledge of the IBM System/360 described in the *IBM System/360 Principles of Operation*, GA22-6821.

For additional information relating to the Model 25, refer to:

IBM System/360 Model 25 Functional Characteristics, GA24-3510.

IBM System/360 Model 25 Operating Procedures, GA24-3523. (12 pages)

GA24-3550 3215 Printer Keyboard 03
Component Description

This reference publication describes the function and operation of the IBM 3215 Console Printer-Keyboard Model 1. Also presented are the printing method, control keys and lights, functional timing, and forms controls and specifications.

For system operation (including programming) refer to *IBM System/370 Principles of Operation*, Order Number GA24-7000, and *IBM System/370 Model 155 Functional Characteristics*, GA22-6942. (3 pages)

GA24-3551 IBM 2956-5 Component 03
Description

This publication provides an introduction to the 2956-5 Multi-Pocket Reader Sorter. General information on operating controls and procedures is presented only in the areas that are different from the IBM 1419 Magnetic Character Reader. Command-byte structure and sense indications are provided for programmer use. For additional information, refer to the *IBM 1219 Reader Sorter*, *IBM 1419 Magnetic Character Reader*, Order Number GA24-1499. (20 pages)

GA24-3552 IBM 3210 Console 03
Printer-Keyboard Model 2
Component Description

This publication describes the functional characteristics and the control keys and lights of the IBM 3210 Console Printer-Keyboard Model 2. (4 pages)

GA24-3554 IBM System/370 Model 145 01
Operating Procedures

This manual contains reference material and operating procedures required to operate the IBM System/360 Model 145 Processing Unit and the following integrated attachments:

Console File

Console Printer-Keyboard

The reader is assumed to have basic computer knowledge and previous operating experience on a similar system. Order Numbers for manuals containing operating procedures for individual input/output devices and 1400/7010 Emulators. (52 pages)

GA24-3557 IBM System/370 Model 145 01
Functional Characteristics Manual

This publication describes the relationship of the Model 145 to other System/370 models and to System/360. Included is information concerning the system features and capabilities, console file, input/output channels, integrated file adapter, OS/DOS compatibility, IBM 1401, 1440, 1460, 1410, and 7010 emulation features, console printer-keyboard, additional instructions, and instruction timings.

The following IBM manuals offer information to assist the reader:

System/370 Model 145 Operating Procedures, Order Number GA24-3554.

System/370 Principles of Operation, Order Number GA22-7000.

System/370 System Summary, Order Number GA22-7001.

System/370 Input/Output Configurator, Order Number GA22-7002.

System/360/370 Bibliography, Order Number GA22-6822.

System/360 Principles of Operation, Order Number GA22-6821.

System/360 Component Descriptions.

IBM 2314 Direct Access Storage Facility and IBM 2844 Auxiliary Storage Control, Order Number GA26-3599.

System/360 I/O Interface—Channel to Control Unit Original Equipment Manufacturers' Information, Order Number GA22-6843.

System/360 Direct Control and External Interrupt Feature, Original Equipment Manufacturers' Information, Order Number GA22-6845.

System/360 OS Program Planning Guide for the DOS Emulator on the System/370, Order Number GC24-5076.

3210 Console Printer-Keyboard Model 2 Component Description, Order Number GA24-3552.

3215 Console Printer-Keyboard Model 1 Component Description, Order Number GA24-3550.

Forms Design Considerations—System Printer, Order Number GA24-3488. (52 pages)

GA26-1589 Component Summary— 07
2835 Storage Control
2305 Fixed Head Storage

This publication contains basic information about the IBM 2835 Storage Control, Models 1 and 2, and the IBM 2305 Fixed Head Storage, Models 1 and 2.

The 2835 is designed for attachment to IBM System/360's and System/370's that include either the IBM 2880 Block Multiplexer Channel or channels with equivalent characteristics.

This publication outlines the major functions of the facility and provides a general description of standard functions, such as multiple requesting, rotational position sensing, and alternate track sparing. The two-channel switch, a special feature, is also described.

It is assumed that the reader of this publication has a general understanding of direct access storage concepts and is familiar with the central processing unit and channel program control operations as described in *IBM System/360 Principles of Operation*, Order Number GA22-6821, or *IBM System/370 Principles of Operation*, Order Number GA22-7000. (20 pages)

GA26-1592 Component Summary— 07
3830 Storage Control
3330 Disk Storage

This manual contains basic information about the IBM 3830 Storage Control and 3330 Disk Storage. These products combine to provide a high speed, large capacity disk storage facility for IBM System/360's and System/370's that have channels meeting the attachment requirements.

The manual outlines the major functions of the 3330 facility and provides a general description of new standard functions, such as multiple requesting and rotational position sensing. The two-channel switch special feature operation for the facility is also described. A functional description of the switches and indicators associated with 3330 facility operator panels is given in Appendix A.

It is assumed that the reader is familiar with direct access storage devices and CPU/channel program control of I/O operations as described in *IBM System/360 Principles of Operation*, Order Number GA22-6821; or *IBM System/370 Principles of Operation*, Order Number GA22-7000. (20 Pages)

GA26-1593 IBM 2968 Model 11 13
Audio/Visual Control: Component
Description and Operating
Procedures RPQ Number F-30209

This manual explains the characteristics, functions, features, physical planning, and operating procedures for the IBM 2968 Model 11 Audio/Visual Control. The manual also describes the various types of equipment and configurations for an audio/visual presentation, the preparation of the slides for the projector, the preparation of audio tape for the tape recorder, and guidelines for selecting a viewing screen for the projector.

A basic knowledge of the IBM 2740 Communications Terminal is assumed. (36 pages)

GA26-1606 IBM 2319 Disk Storage 07
Component Summary

This manual contains basic information about the IBM 2319 Disk Storage. This product provides high speed, large capacity direct access storage for the IBM System/370 Model 145.

The reader should be familiar with the publication *IBM SYSTEM/360 Component Descriptions—2314 Direct Access Storage Facility and 2844 Auxiliary Storage Control*, Order Number GA26-3599. (20 pages)

GA26-3567 IBM 2311 Disk Storage 19
Drive Original Equipment Manu-
facturers' Information

This manual contains information that will assist non-IBM engineers in attaching the IBM 2311 Disk Storage Drive to their equipment. It includes a general description of machine functions, a reference listing of publications and engineering documents, and information concerning machine interface not readily available in other publications. (8 pages)

GA26-3574 IBM 2321 Data Cell 19
Drive—OEMI

This publication contains information for engineers who plan to attach the IBM 2321 Data Cell Drive to their equipment.

The information includes a general description of machine functions, a reference listing of useful publications and engineering documents, and information concerning machine interfaces. (22 pages)

GA26-3599 IBM System/360 Compo- 07
nent Descriptions—2314 Direct Access
Storage Facility and 2844 Auxiliary
Storage Control

This publication describes the IBM 2314 Direct Access Storage Facility and the IBM 2844 Auxiliary Storage Control, and presents functional and operating characteristics for these devices. Capacities, timing considerations, commands, operating procedures, and sense and status information are described. The user of this publication should be thoroughly familiar with the I/O programming considerations described in *IBM System/360 Principles of Operation*, Order Number GA22-6821. (62 pages)

GA26-3633 Data Cell Handling Guide 07

This manual provides suggested operating and handling procedures for the IBM Data Cell used with the IBM 2321 Data Cell Drive. (12 pages)

GA26-3699 IBM 1971-1980 Custom 13
Terminal Functional Characteristics,
Operating Procedures, and Physical
Planning

This manual describes the operations, controls, and special features of the IBM 1971 Buffered Terminal Control (Models 30 and 35) and the IBM 1980 Buffered Terminal (Models 9 and 12). The communications facilities that can be used with this Teleprocessing terminal are described. Appendixes, containing the physical planning specifications, RPQ numbers, a glossary of terms, and general typewriter maintenance are provided. (48 pages)

GA26-5661 IBM 2301 Drum Storage 19
Original Equipment Manufacturers'
Information

This publication provides definitions and functional descriptions of the interface lines for the 2301 Drum Storage. It also contains specifications, timings, and cable information. (10 pages)

GA26-5663 IBM 2303 Drum Storage 19
Original Equipment Manufacturers'
Information

This publication provides definitions and functional descriptions of the interface lines for the 2303 Drum Storage. It also contains specifications, timings, and cable information. (11 pages)

GA26-5714 IBM 2314/2844 Multiplex 13
Storage Control Feature—Airlines
Buffer

This publication describes the IBM 2314/2844 Multiplex Storage Control Feature (RPQ number S50001). This feature allows the 2314/2844 to operate in its basic mode or in multiplex mode. This publication describes formed in multiplex mode. For a description of 2314/2844 basic mode operations, refer to the Systems Reference Library publication *IBM System/360 Component Descriptions—2314 Direct Access Storage Facility and 2844 Auxiliary Storage Control*, Order Number GA26-3599. (60 pages)

GA26-5756 IBM Disk Pack and Cartridge 07
Handling Procedures

This manual is a guide for handling IBM Disk Packs and Cartridges. The information contained in this manual applies to IBM 1316 and 2316 Disk Packs and 2315 Disk Cartridges. (12 pages)

GA26-5988 IBM System/360 07
Component Descriptions—
DASD for 2841

This publication contains reference information for the operation and programming of direct access storage devices (DASD) that attach to the IBM 2841 Storage Control. These devices include: IBM 2311 Disk Storage Drive Model 1; IBM 2302 Disk Storage Models 3 and 4; IBM 2303 Drum Storage; and IBM 2321 Data Cell Drive. (66 pages)

GA26-5993 IBM System/360 Custom 13
Feature 2972 Line Control Unit
Model 1

This publication presents a description of the operation of the IBM 2972 Line Control Unit Model 1. A sample configuration and a description of operation sequence are included. (20 pages)

GA27-2700 IBM System/360 Component 03
Description—IBM 2260 Display Station
IBM 2848 Display Control

This manual describes the functional and operating characteristics of the IBM 2260 Display Station and the IBM 2848 Display Control. The two units combine to form a display complex that provides visual access to data stored in an IBM System/360. A variety of models and features permit 2260/2848 configurations that range from a 2848 with a single display-only 2260 to a multiple-station display complex, each station of which can be used as a direct-entry terminal as well as a means of rapidly assessing and displaying computer-stored data. This manual contains Principles of Operation sections for the local and remote applications of the display complex, and for the "data entry" 2260/2848 configuration as well. (88 pages)

GA27-2701 IBM System/360 03
Component Description—IBM 2250
Display Unit Model 1

This publication contains detailed information on programming, operation, and special features of the IBM 2250 Display Unit Model 1. The material is presented with the assumption that the reader has read the *IBM System/360 Principles of Operation*, Order Number GA22-6821.

The following publications may also be of interest to the reader:

IBM System/360 Component Description: IBM 2250 Display Unit Model 3; IBM 2840 Display Control Model 2, Order Number GA27-2721.

IBM System/360 Operating System Graphic Programming Services for IBM 2250 Display Unit Model 1, Order Number GC27-6921.

(44 pages)

GA27-2702 IBM System/360 03
Component Description
IBM 2250 Display Unit Model 2
IBM 2840 Display Control Model 1

This document presents detailed information about IBM 2250 Display Unit Model 2/IBM 2840 Display Control Model 1 programming, operation, and special features. The material is presented with the assumption that the reader has read the *IBM System/360 Principles of Operation*, Order Number GA22-6821.

The following publications may also be of interest to the reader:

IBM System/360 Component Description: IBM 2250 Display Unit Model 1, Order Number GA27-2701.

IBM System/360 Component Description: IBM 2280 Film Recorder, IBM 2282 Film Recorder/Scanner, Order Number GA22-6853.

IBM System/360 Operating System, Graphic Programming Services for IBM 2250 Display Unit, Preliminary Specifications, Order Number GC27-6909.

Each 2250 Model 1 attaches directly to the System/360 channel and is not used with the 2840 Display Control. Each film unit attaches to a 2840 Display Control Model 1 by means of a 2840 special feature and shares common 2840 circuitry with the attached 2250-2 Display Unit(s). Various film unit/2250-2 configurations are described in the film unit publication. (48 pages)

GA27-2703 IBM 2703 Transmission 09
Control Component Description

This publication provides a detailed description of the capabilities, features, and communication facilities required for the IBM 2703 Transmission Control Unit. The capabilities of the unit are grouped by: start-stop capabilities; and binary-synchronous capabilities. All items of a general nature are discussed in the section, "Detailed Description of Operations."

The operator's controls and a detailed description of the communication facilities to which the 2703 can be attached are contained in the Appendix. For a complete listing of all SRL publications available in the IBM System/360 library, including abstracts, consult the *IBM System/360 Bibliography*, Order Number GA22-6822. (78 pages)

GA27-2704 IBM System/360 09
Component Description—IBM 2711
Line Adapter Unit

This manual describes the operation of the IBM 2711 Line Adapter Unit. Included is a general description of the 2711, the line adapters that can be contained in a 2711, the communication facilities that can be used with the 2711, and the operational functions of the line adapters. (6 pages)

GA27-2706 IBM 7770 Audio Response 19
Unit Model 3, IBM 7772 Audio Re-
sponse Unit Original Equipment
Manufacturers' Information

The purpose of an OEMI manual is to provide information to enable another manufacturer to design equipment that can be used with IBM systems or devices. The OEMI manual provides supplemental data not found in other IBM publications. This manual describes the IBM 7770 Model 3 and IBM 7772 Audio Response Units. These units are capable of connecting an IBM System/360, via the multiplexor channel, to a telephone network. (32 pages)

GA27-2710 IBM 7772 Audio Response 09
Unit Vocabulary

This publication obsoletes the SRL Manual *IBM 7772 Audio Response Concepts and Vocabulary*, Order Number GA22-6847. It contains a complete listing of the 7772 vocabulary. (8 pages)

GA27-2711 IBM System/360 09
Component Description—IBM 7772
Audio Response Unit

This manual describes the functional and operational characteristics of the IBM 7772 Audio Response Unit. Topics include vocabulary selection, system attachment considerations, communications requirements, and programming considerations. This manual supersedes IBM Systems Reference Library publications *IBM 7772 Audio Response Unit with System/360*. Order Number GA22-6836. (29 pages)

GA27-2713 System/360 Model 67 00
Processor Unit Configurator

Configurator sheet, 17 x 11", one side, two folds. Sheet shows all possible units that can be configured on the System/360 Model 67. (1 page)

GA27-2715 IBM System/360 Special 13
Feature Description—709/7040/7044/
7090/7094 II Compatibility Feature
for IBM System/360 Models 65 and 67

This publication contains information about the IBM 7090 Compatibility Feature (#7119). The Compatibility Feature adds interpretive facilities to System/360 Models 65 and 67 for use by the IBM 7090 Emulator Program. The combination of the feature and the program, referred to as the 7090 Emulator, allows execution on IBM System/360 Models 65 and 67 of programs written for the IBM 709, 7040, 7044, 7090, 7094, and 7094 II. (58 pages)

GA27-2716 IBM System/360 Special 13
Feature Description—7080 Com-
patibility Feature for System/360
Model 65

This publication presents a detailed description of the IBM 7080 Compatibility Feature #7118. The Compatibility Feature adds interpretive facilities to System/360 for use by the IBM 7080 Emulator Program, Program No. 360C-EU-727. This combination of feature and program, referred to as the IBM 7080 Emulator, permits an IBM System/360 Model 65 to execute programs written for an IBM 7080 Data Processing System. (38 pages)

GA27-2717 IBM System/360 Special 13
Feature Description—7074 Com-
patibility Feature for System/360
Models 50 and 65

This publication contains information about the IBM 7070/7074 Compatibility Feature. The Compatibility Feature adds interpretive facilities to System/360 Model 50 or 65 for use by the IBM 7074 emulator program. The combination of the feature and the program, referred to as the 7074 Emulator, allows execution on IBM System/360 Models 50 and 65 of programs written for the IBM 7070 and 7074. (34 pages)

GA27-2719 IBM System/360 Model 01
67 Functional Characteristics

This publication contains detailed information on the organization, characteristics, features, and functions unique to the IBM System/360 Model 67 Time Sharing System. Major areas described include time-sharing philosophy, system structure, new units, generalized information flow, standard and special features, instruction timings, and the system control panel.

Descriptions of specific input/output devices used with the Model 67 appear in separate publications. See the *IBM System/360 Bibliography*, Order Number GA22-6822 for a listing and a brief description of these publications.

The material in this publication is presented with the assumption that the reader has knowledge of System/360 as defined in the *IBM System/360 Principles of Operation*, Order Number GA22-6821 and the *IBM System/360 System Summary*, Order Number GA22-6810. The *IBM System/360 Model 67 Configurator*, Order Number GA27-2713 also may be of interest to the reader. (68 pages)

GA27-2721 IBM System/360 03
Component Description—IBM 2250 Display Unit Model 3—IBM 2840 Display Control Model 2

This document presents detailed information about IBM 2250 Display Unit Model 3/IBM 2840 Display Control Model 2 programming, operation, and special features. The material is presented with the assumption that the reader has read the *IBM System/360 Principles of Operation*, Order Number GA22-6821. (67 pages)

GA27-2724 IBM System/360 Custom 15
Systems Unit—2916 Long Line Adapter, Models 3 and 4 Installation Bulletin—Physical Planning

This bulletin contains all the necessary physical planning data required for the installation of the unit described. If the unit is to be installed in conjunction with a computer system, the specifications of the most critical unit must be met. The data follows the same format and utilizes the same standardized symbols as used in the *IBM System/360 Installation Manual—Physical Planning*, Order Number GC22-6820. (4 pages)

GA27-2725 IBM System/360 10
Component Description—IBM 50 Magnetic Data Inscrber

This manual describes the functional and operating characteristics of the IBM 50 Magnetic Data Inscrber. The IBM 50 Magnetic Data Inscrber is a key-operated device that records data on cartridge-contained magnetic tape. Each IBM 50-generated tape can be used as a data storage medium or as a vehicle for entering data into an IBM System/360, via the IBM 2495 Tape Cartridge Reader. In addition to its data recording capability, the IBM 50 can also be used to verify data stored on tapes generated on the same or other IBM 50's. (20 pages)

GA27-2726 IBM System/360 05
Component Description—IBM 2495 Tape Cartridge Reader

This manual describes the functional and operating characteristics of the IBM 2495 Tape Cartridge Reader (TCR). The IBM 2495 TCR is used to transfer data stored on cartridge-contained 16mm magnetic tape to an IBM System/360. The TCR accepts cartridge tapes containing data generated on either the IBM 50 Magnetic Data Inscrber or the IBM Magnetic Tape Selectric Typewriter System. (12 pages)

GA27-2727 IBM System/360 Custom 15
Systems Unit—2909 Model 3 Asynchronous Data Channel—RPQ F13299/RPQ 882045 Installation Bulletin—Physical Planning

This bulletin contains all the necessary physical planning data required for the installation of the unit described. If the unit is to be installed in conjunction with a computer system, the specifications of the most critical unit must be met. This bulletin utilizes the same format and standardized symbols contained in the *IBM System/360 Installation Manual—Physical Planning*, Order Number GC22-6820. (6 pages)

GA27-2728 IBM System/360 Model 65 01
Operating Procedures

This manual describes operator procedures for an IBM 2065 Processing Unit, operating with or without an associated IBM 1052 Printer-Keybaord. Also described are system control panel machine functions, machine procedures, program-oriented procedures, and operator-intervention procedures. An appendix of reference material and an index are included.

The reader is assumed to have a knowledge of the following SRL publications:

IBM System/360 Principles of Operation, Order Number GA22-6821 (sections on "System Structure" and "System Control Panel")

IBM System/360 Model 65 Functional Characteristics, Order Number GA22-6884

IBM System/360 Tape Operating System Operating Guide, Order Number GC24-5021

IBM System/360 Disk Operating System Operating Guide, Order Number GC24-5022

IBM System/360 Operating System Operator's Guide, Order Number GC28-6540

For information pertaining to the operation of I/O units that are attachable to the System/360 Model 65, refer to the appropriate SRL publication. All System/360 SRL publications that pertain to IBM System/360 and attachable units are abstracted and referenced by form number in *IBM System/360 Bibliography*, Order Number GA22-6822. (46 pages)

GA27-2729 IBM System/360 Custom 15
Systems Unit—2972 Model 7 Scientific Interface Control Unit, RPQ E46181; Installation Bulletin—Physical Planning

This bulletin contains all the necessary physical planning data required for the installation of the unit described. If the unit is to be installed in conjunction with a computer system, the specifications of the most critical unit must be met. This bulletin utilizes the same format and standardized symbols contained in the *IBM System/360 Installation Manual—Physical Planning*, Order Number GC22-6820. (4 pages)

GA27-2730 IBM 2285 Display Copier 03
Component Description

This publication presents a functional description of, and operator procedures for, the IBM 2285 Display Copier. Each 2285 attaches directly to an IBM 2250 Display Unit Model 1, 3, or 4 that is equipped with an attachment feature. The 2285 provides an

8½-by-11-inch paper copy output of the associated 2250 display upon initiation by the 2250 operator. The 2285 obtains analog signals and power from the 2250 to which it is attached and requires no programming. The following publications may be of interest to the reader.

IBM System/360 Component Description: IBM 2250 Display Unit Model 1, Order Number GA27-2701.

IBM System/360 Component Description: IBM 2250 Display Unit Model 3 IBM 2840 Display Control Model 2, Order Number GA27-2721.

IBM 1130 System Component Description: IBM 2250 Display Unit Model 4. Order Number GA27-2723. (2 pages)

GA27-2731 IBM System/360 03—
Component Description—IBM 2265 Display Station IBM 2845 Display Control

This manual describes the functional and operating characteristics of the IBM 2265 Display Station and the IBM 2845 Display Control. The two units combine to form a display system that provides visual access to data stored in an IBM System/360. This manual also contains a Principles of Operation section for remote applications of the display system. (48 pages)

GA27-3002 2740/2741 Communication 19
Terminal—Original Equipment Manufacturers' Information

To assist non-IBM engineers in attaching the IBM 2740 or 2741 Communication Terminal to their equipment, this manual describes in detail important interface considerations such as physical connections, line adapting equipment, signals and data flow, codes, power requirements, power supply, configurations, timing considerations, and line control, as well as descriptions of the terminals themselves. To provide information on the IBM Line Adapters appropriate for use with 2740/2741 Communication Terminals, this manual refers to *Planning and Installation of a Data Communications System Using IBM Line Adapters*, Order Number GA24-3435. (46 pages)

GA27-3005 IBM 2780 Data Transmission 05
Terminal—Component Description

This Component Description manual describes the principles of operation of the IBM 2780 Data Transmission Terminal. The data-link control characters, code structures, timeouts, and throughput rates associated with the Binary Synchronous method of transmission are described.

The communications facilities, data sets, and special features available for this teleprocessing terminal are also discussed. As an introduction to the Binary Synchronous method of transmission, refer to the manual *General Information—Binary Synchronous Communications*, Order Number GA27-3004.

Additional information on the Binary Synchronous method of transmission when using an IBM 2701 or IBM 2703 can be found in the following publications:

IBM 2701 Data Adapter Unit—Component Description, Order Number GA22-6864.
IBM 2703 Transmission Control—Component Description, Order Number GA27-2703.

(80 pages)

GA27-3012 IBM 2702/2703 19
Transmission Controls—Original
Equipment Manufacturers' Information

This publication describes the IBM 2702/2703 Transmission Control interfaces. The processor interface description includes a description of the operating signals and responses. The interface descriptions provide device attachment information. The electrical, mechanical, and cabling specifications of these interfaces are provided, together with physical planning requirements. (110 pages)

GA27-3029 Component Description: 09
IBM 2721 Portable Audio Terminal

This publication describes the functional and operational characteristics of the IBM 2721 Portable Audio Terminal when communicating with an IBM System/360 via an IBM 7770 Model 3 Audio Response Unit.

Topics discussed include terminal features, suggested applications, communications requirements, codes, keyboard overlays, environmental requirements and programming considerations. (28 pages)

GA27-3039 IBM 2721 Portable Audio 09
Terminal Operator's Handbook

This manual provides instructions for installing and operating the IBM 2721 Portable Audio Terminal. A section on problem determination is provided to assist the operator in deciding if the terminal requires maintenance.

For more detailed information on the functions and operation of the terminal, refer to the Systems Reference Library Manual, Component Description: IBM 2721 Portable Audio Terminal, Order Number GA27-3029. (16 pages)

GA27-3041 IBM 1970 Model 1 Remote 15
Audio Response Unit Installation
Manual—Physical Planning

This manual furnishes specific details of the physical characteristics of the IBM 1970 Model 1 Remote Audio Response Unit. Included are dimensions, weights, service clearances, head output, air flow, and electrical and environmental requirements. Also included is ordering information for the basic machine and available features. Planning assistance is also available from IBM sales and installation planning representatives. (16 pages)

GA32-0004 IBM 2420 Model 7 05
Magnetic Tape Unit Original
Equipment Manufacturers' Information*

This manual contains detailed electrical, mechanical and cabling considerations and specifications concerning tape, control-tape unit interface for the IBM 2420 Model 7 Magnetic Tape Unit. (24 pages)

GA32-0006 Tape Specifications for IBM 05
One-Half Inch Tape Drives At:
556 and 800 BPI and 3200 FCI
Manual

This manual provides the specifications and requirements for magnetic tape to be used on IBM Tape Drives. The specifications are presented in two parts: General information and Tape Properties Essential for IBM Tape Drive Use. The later section covers minimum properties required for tape use on all IBM Tape Drives. (16 pages)

GA32-0007 IBM 2420 Model 5 05
Magnetic Tape Unit—Component
Description Bulletin

This bulletin describes the characteristics, functions, and features of the IBM 2420 Model 5 Magnetic Tape Unit. (8 pages)

GA32-0012 3803/3420 Magnetic Tape 05
Subsystems

This manual describes the IBM 3803 Model 1 Tape Control and the IBM 3420 Models 3, 5, and 7 Magnetic Tape Units. The 3803 Model 1 tape control provides communication between the tape units and the system input/output interface. The 3420 Models 3, 5, and 7 tape units read and write one-half inch magnetic tape at 75, 125, and 200 inches per second, respectively. All three basic tape units read and write nine-track, 1600 bytes per inch, phase-encoded format. Nine-track, 800 bpi NRZI recording mode is available as a feature on all models. Seven-track, 556/800 bpi NRZI recording mode is an optional feature on 3420 Models 3 and 5 only.

A reader should be familiar with *IBM System/360 I/O Interface, Channel to Control Unit, Original Equipment Manufacturers' Information*, Order Number GA22-6843, and *IBM System/360 Principles of Operation*, Order Number GA22-6821 (sections on input/output operations). System/370 users should also refer to *IBM System/370 Principles of Operation*, Order Number GA22-7000. (36 pages)

GA33-4500 IBM System/360 Component 03
Descriptions—2826 Paper Tape Control
Unit, 1017 Paper Tape Reader, 1018
Paper Tape Punch

This publication describes the above named paper tape input/output components for the reading and punching of paper or Mylar* tape. Attachment is

to the multiplexer channel of the IBM System/360 Models 25, 30, 40, and 50. The channel commands necessary to control the operation of the above units, and the status and sense bytes provided by the control unit, are fully described.

Controls, tape specifications, tape-splicing procedures, tape-loading procedures, and special features are also described.

Detailed information about System/360 channel operations is included in the Systems Reference Library *IBM System/360 Principles of Operation*, Order Number GA22-6821. (48 pages)

*Trademark of E.I. du Pont de Nemours & Co. (Inc.)

GA36-0001 IBM 4872 Modem Model 1 09

This publication contains detailed information on installation, operation and special features of the IBM 4872 Modem, Model 1. (16 pages)

GA36-0002 IBM 4481 Film 03
Reader/Recorder

This publication provides basic information about the IBM 4481 Film Reader/Recorder, with the objective of helping readers to achieve a general understanding of the machine's operation, its interface with the IBM System/360 through the IBM 1827 Data Control Unit, and its functional characteristics. Programming considerations, timing information, operator controls, and installation planning are discussed in detail. (36 pages)

GA36-0003 IBM 4481 Film Reader/ 03
Recorder Programmer's Guide

This publication provides information that will enable the user to write programs for the IBM 4481 Film Reader/Recorder. Programming considerations are discussed prior to acquainting the user with the software support designed for his use. The use-oriented support programs comprise a set of macro-instructions which control data flow between the System/360 Central Processing Unit and the Film Reader/Recorder, and a selection of FORTRAN callable subroutines and image handling programs which perform transmission of data to and from the Film Reader/Recorder. (46 pages)

LCB6-3772 IBM System/360 Operating 21
System Assembler H Assembly Listings
(Microfiche) Program Number 5734-AS1
Microfiche, 84 Cards **Licensed—
Property of IBM**

Assembler listings of OS Assembler H (5734-AS1) in microfiche form. (84 cards)

LCB8-6757 System/360 Disk Operating 33
System Sort/Merge Microfiche, 84 Cards

Contains Type 1 OS Program Listings and DOS/OS PTF listing. (64 cards)

GC19-0001 IBM System/360 15
Installation Manual—IBM World Trade
50-Cycle Physical Planning Require-
ments (for World Trade Use Only)

This publication is a version of IBM System/360 Installation Manual—Physical Planning, Order Number GC22-6820; it is limited to IBM World Trade requirements.

This manual contains preliminary physical information for installing the IBM System/360. (164 pages)

GC20-1618 IBM System/360 Number 95
Systems

This IBM student text on number systems presents a brief review of the principles of positional notation, as applied to the binary and hexadecimal systems of notation. The publication covers the operations of binary and hexadecimal arithmetic, decimal-binary-hexadecimal base conversion, and the principles of base and base-minus-one complementation. (18 pages)

GC20-1619 Catalog of Programs for IBM 20
System/360—June 1968

This Catalog contains a complete listing of all programs for the IBM System/360 available from the Program Information Department, 40 Saw Mill River Road, Hawthorne, New York 10532.

Instructions for ordering programs are contained in the section of the Introduction entitled, "How to Order Programs." (144 pages)

SC20-1637 PL/I Guide for FORTRAN 29
Users

This text is an introductory guide to PL/I, written especially for those who have a working knowledge of FORTRAN II or IV. It does not attempt to cover all the features of the language. It should prepare the student to write a straightforward PL/I program. (40 pages)

SC20-1646 A Programmer's Introduction 95
to the IBM System/360 Architecture,
Instructions, and Assembly Language

This text is intended to introduce the student to the characteristics of the System/360 and to its instruction set. Many sample programs are used throughout to illustrate specific instructions and programming techniques. It is expected that the student has some knowledge of computing systems.

This publication incorporates but does not obsolete the following IBM System/360 Student Texts:

Fixed-Point Operations, Order Number GC20-1613; *Programming with Base Registers and the USING Instruction*, Order Number GC20-1614; *Introduction to Assembler Language Programming*, Order Number GC20-1615; *Decimal Operations*, Order Number GC20-1616; *Number Systems*, Order Number GC20-1618; *Logical Operations on Character and Bits*, Order Number GC20-1623; *Edit, Translate, and Execute Instructions*, Order Number GC20-1624; *Subroutines and Subprograms*, Order Number GC20-1625.

The new material in this text includes the chapters on "Architecture", "Automatic Interrupts," and "Floating Point and Advanced Loops in Scientific Applications."

No attempt at completeness is made, and therefore it is expected that the student will refer to the appropriate SRL publications for additional detail. (218 pages)

GC20-1649 Introduction to IBM 95
System/360 Direct Access Storage
Devices and Organization Methods

This student text discusses the physical characteristics and capacities of the following System/360 Direct Access Storage Devices: 2301 Drum Storage, 2302 Disk Storage, 2303 Drum Storage, 2311 Disk Storage Drive, 2314 Direct Access Storage Facility, and 2321 Data Cell Drive.

The file organization methods and access methods provided for these devices by the IBM System/360 Basic Operating System, the IBM System/360 Disk Operating System, and the IBM System/360 Operating System are also discussed. The uses of direct access storage basic terminology, and the establishment of controls for a direct access system are other topics addressed by this text. Most of the chapters end with student exercises, the answers to which may be found at the end of the manual.

No attempt at completeness is made. Refer to the publications listed in the Bibliography for additional details. (76 pages)

GC20-1650 IBM System/360 Model 30 13
1401 Compatibility Mode
Operator's Manual

This manual has been prepared to aid the 1401 operator in transferring to Compatibility Mode Operation on a System/360 Model 30. Only those procedures that differ from their counterparts on the 1401 are discussed. Detailed run book entries are presented for each functional operator action. Procedures can be incorporated into the installation's 1401 run book(s) to provide a single source of operator reference. (56 pages)

SC20-1651 A Guide to PL/I for 95
Commercial Programmers

This publication presents those features of PL/I that apply to commercial data processing. It does not restrict itself to a particular aspect of commercial data processing but attempts to discuss all features of PL/I that may be used in the full spectrum of commercial applications.

Because of the many similarities between PL/I and COBOL (Common Business Oriented Language), each chapter in this publication concludes with a section showing comparisons of two languages. The material in this publication is quite comprehensive, but by no means is it a complete description of PL/I nor does it represent the definitive treatment of any one language feature. (69 pages)

GC20-1667 Introduction to IBM 95
System/360 Architecture

This text is intended to introduce the student to the characteristics of System/360. It is expected that the student has some knowledge of computing systems.

This publication contains the same information as Chapter 1 of *A Programmer's Introduction to the IBM System/360 Architecture, Instructions, and Assembly Language*, Form C20-1646 and obsoletes *IBM System/360 Introductory Notes*, Order Number GC20-1608.

No attempt at completeness has been made, and, therefore, it is expected that the student will refer to the appropriate Systems Reference Library (SRL) publications for additional detail. (32 pages)

SC20-1682 IBM System/360 Model 95
30—IBM System/360 Tape Operating
System
System Operation Training Manual

This publication must be used together with *IBM System/360 Model 30—IBM System/360 Tape Operating System—System Operation Training Manual, Book of Illustrations*, Form C20-1683. They are intended to introduce the student to many of the procedures to be followed when operating the IBM System/360 Model 30. This publication describes the system, various input and output devices, and, through the explanation of sample jobs, illustrates how personnel operate the system in an IBM System/360 Tape Operating System (TOS) stacked-job processing environment.

A student with no prior experience in the data processing field can use this text. In most cases, however, it is expected that the text will be used after the completion of units 1, 4, 5, and 6 of the programmed instruction course *Computing System Fundamentals*, Course Y9897-88. The materials for these units include the following booklets: Order Number GR29-0241, Order Number GR29-0242, Order Number GR29-0245 through Order Number GR29-0248. (56 pages)

SC20-1683 IBM System/360 Model 95
30—IBM System/360 Tape Operating
System
System Operation Training Manual,
Book of Illustrations

This publication contains the illustrations for *IBM System/360 Model 30—IBM System/360 Tape Operating System—System Operation Training Manual*, Order Number SC20-1682. (80 pages)

GC20-1685 System/360 Disk 50
Operating System User's Guide:
Control Statement Techniques

This publication provides guidance in the use of control statements as related to compilations, linkage editing, utilities, sorts, and user programs. It presents tested examples with supporting explanations as an aid to understanding the input stream requirements for processing in the System/360

Disk Operating System environment. The control statements discussed are job control statements, linkage editor control statements, and operator commands.

A list of related publications appears in the Preface. (86 pages)

GC20-1688 IBM 2260 Display Station—IBM 2848 Display Control—IBM 1053 Printer Operator's Manual 03

This manual describes the operating characteristics of the IBM 2260 Display Station and the IBM 2848 Display Control. The two units combine to provide visual access to data stored in an IBM System/360.

This manual also contains a section on operating the IBM 1053 Printer that can be attached to this system for printing the messages displayed on the screen.

All functions described in this manual refer to the Models 1 and 2 of the 2260, Models 1, 2, and 3 of the 2848, and Model 4 of the 1053. (20 pages)

SC20-1689 Introduction to the Compile-Time Facilities of PL/I 95

The compile-time facilities of PL/I provide a convenient way of modifying and completing a PL/I program before it is finally translated into a set of machine-language instructions. PL/I supplies these facilities through a special set of source statements, called the preprocessor (or compile-time) statements which specify operations to be performed at compile time upon the text of a source program. The features, the formats, and the restrictions of preprocessor statements are discussed in this student text. Illustrative applications accompanied by actual compilation listings appear with the discussions. (44 pages)

GC20-1706 Coursewriter III 95

The intent of this publication is to get a new author working on his material as soon as possible. Course material so prepared may not be the ultimate in Coursewriter III Language usage, but it will be available for student use in the shortest possible time.

This student text guides the new author of course materials through the language by a step-by-step presentation. The text is not all-inclusive but contains the basics of the Coursewriter III Language and many examples of operation code and author command use. The author is assumed to be familiar with the use of the IBM terminal he is using. If he is not, COURSEWRITER III FOR SYSTEM/360, STUDENT/MONITOR USER'S GUIDE (Order Number GH20-0608) should be studied before going any further.

Once this student text has been read, the author may refer to COURSEWRITER III FOR SYSTEM/360, AUTHOR'S GUIDE (GH20-0609) for greater detail on operation codes, author commands, and other related information.

Other IBM publications concerned with Coursewriter III, Version 2, include:

- IBM Terminal Coursewriter III Reference Card for Student and Monitor Users – Order Number GX20-1780
- IBM Author's Coursewriter III Reference Card – Order Number GX20-1782
- IBM Supervisor's Coursewriter III Reference Card – Order Number GX20-1782
- Coursewriter III Instruction Sheet – Order Number GX20-1750
- Coursewriter III for System/360 Application Description – Order Number GH20-0587
- Coursewriter III for System/360 Supervisor's Guide – Order Number GH20-0610
- Coursewriter III for System/360 System Programmer's Guide – Order Number GY20-0372.

(77 pages)

GC20-1729 A Guide to the IBM System/370 Model 155 99

This guide presents hardware, programming systems, and other pertinent information about the IBM System/370 Model 155 that describes its significant new features and advantages. Its contents are intended to acquaint the reader with the Model 155 and to be of benefit in planning for its installation. (136 pages)

GC20-1730 A Guide to the IBM System/370 Model 165 99

This guide presents hardware, programming systems, and other pertinent information about the IBM System/370 Model 165 that describes its significant new features and advantages. Its contents are intended to acquaint the reader with the Model 165 and to be of benefit in planning for its installation. (120 pages)

GC20-1731 Guide to Transition From System/360 Disk Operating System To IBM System/360 Operating System 99

This publication provides information pertinent to the transition from IBM System/360 Disk Operating System (DOS) to System/360 Operating System (OS). It is intended for use by systems and programming personnel as an aid to planning and implementing the transition from DOS to OS. The text is based on OS Release 18 and DOS Release 23.

Along with other topics covered, the manual presents considerations concerning DOS and OS data sets, programming languages, job control language, sorts, utilities, data management, link editing, standards, transition time estimates, and system control programs.

The reader is assumed to be an experienced DOS user, aware of the concepts, facilities, and terminology of OS. Use of this manual does not preclude the use of OS System Reference Library (SRL) publications. (300 pages)

GC20-1734 A Guide to the IBM System/370 Model 145 01

This guide presents hardware, programming systems, and other pertinent information about the IBM System/370 Model 145 that describes its significant new features and advantages. Its contents are intended to acquaint the reader with the Model 145 and to be of benefit in planning for its installation. (160 pages)

GC20-8011 Random Number Generation and Testing 99

Random sampling—simulation studies—Monte Carlo methods—have been in use for many years. Papers describing various aspects of these topics have appeared in technical journals and textbooks available to a relatively small percentage of computer users. Meanwhile, applications requiring random numbers are becoming more important and more common in business and industry as well as purely scientific areas. This manual gives the mathematical development of the power residue method, outlines computer techniques for implementing it, and also offers brief comments on other methods. An appendix provides programming illustrations for binary and decimal computers. (12 pages)

GC20-8078 Form and Card Design 99

The first section discusses the steps to take and factors to consider in designing a form. The second section describes the various types of cards and the major phases of card design, illustrates and explains design aids, and presents operating and processing factors that affect card design.

This publication can be used as a guide for individual study or a text for class study. It presupposes a knowledge of IBM Data Processing equipment. (15 pages)

GC20-8152 Flowcharting Techniques 99

Adherence to standard techniques for the preparation of flowcharts of data processing systems and procedures greatly increases effectiveness of communication between the programmer analyst and the many groups with whom he deals. The manual describes in detail the preparation of system and program flowcharts. The symbols used are those provided by the new *IBM Flowcharting Template*, Order Number GX20-8020, which contains cutouts for all flowchart symbols. The template envelope gives uses for the symbols. The *Flowchart Worksheet*, Order Number GX20-8021 is a means of standardizing documentation. It provides space for drawing program flowcharts and contains an area for identification of the job, including application, procedure, date and pagination. (34 pages)

- GC21-5000 IBM System/360 Basic 25**
Programming Support Programmer's
Guide FORTRAN IV, (16K Card)
- This publication provides information necessary for:
1. Translating Card FORTRAN IV source programs into System/360 coding.
 2. Executing the resulting System/360 coding.
- Included also are techniques and considerations for improving Card FORTRAN IV programs. These are supplementary to the information provided in the language publication, *IBM System/360 Basic Programming Support Specifications, FORTRAN IV (16K Card)*, Order Number GC21-9040. The user should read that publication before reading this one (88 pages)
- GC21-5001 IBM System/360 Basic 32**
Programming Support Distribution
Program, Specifications and Operating
Guide
- Program Number: 360-UT-208*
- The distribution program is used for maintenance and distribution of the Disk Operating System. This reference publication contains the specifications and operating guide for the distribution program and describes the functions of the program, program deck, control cards, system and deck preparation, error messages and options, and operating instructions.
- The reader should be familiar with the information presented in the publications: *IBM System/360 Basic Operating System, Programmer's Guide* (Order Number GC24-3372) and *IBM System/360 Principles of Operation* (Order Number GA22-6821). For a list of related publications, refer to the *IBM System/360 Bibliography* (Order Number GA22-6822). (36 pages)
- GC21-5004 IBM System/360 Operating 36**
System IBM 1285, 1287, and 1288
Optical Readers Data Management
Macros and Services
- This publication defines and describes the data management macro instructions and services for the IBM Optical Readers. The macro instructions are used in the IBM System/360 Operating System Assembler language. The macro instruction descriptions and definitions apply to the three main configurations of the operating system: systems with the primary control program (PCP); systems that provide multiprogramming with a fixed number of tasks (MFT or option 2); and systems that provide multiprogramming with a variable number of tasks (MVT or option 4). (60 pages)
- GC21-5006 IBM System/360 Operating 36**
System IBM 1419/1275 Data
Management Macro Instructions and
Services
- This publication defines and describes the data management macro instructions and services for the
- IBM 1419. The macro instructions are available in the IBM System/360 Operating System. The macro instruction descriptions and definitions apply to the three main configurations of the operating system: systems with the primary control program (PCP); systems that provide multiprogramming with a fixed number of tasks (MFT or Option 2); and systems that provide multiprogramming with a variable number of tasks (MVT or Option 4). (56 pages)
- GC21-5008 IBM System/360 Oper- 30**
ating System: Planning for the IBM
3211 Printer Data Management Macro
Instructions and Services
- This publication is a planning aid only. It is intended for use *prior* to the availability of the data management macro instructions for the IBM 3211 Printer and shall be replaced by reference documentation when that support becomes available.
- This publication describes macro instructions and services provided under IBM System/360 Operating System for use with the IBM 3211 Printer. (36 pages)
- GC21-5013 System/360 Disk Operating 32**
System IBM 1288 Basic Unformatted
Read System: A Data Capture Utility
Program
- The publication is a reference manual designed to assist you in implementing data entry applications using the IBM 1288 Optical Page Reader. The data must be printed or typed in either USASCSOCR Size A or ISO OCR-A size 1 font in the unformatted mode.
- This manual describes the control and functions of 1288 Basic Unformatted Read System, which include:
- Input and output.
 - Error handling routines.
 - Job control language.
- The program operates under the IBM System/360 Disk Operating System with either BATCH or Multiple Programming Support (MPS). (44 pages)
- GC21-5014 IBM System/360 Operating 32**
System IBM 1288 Basic Unformatted
Read System: A Data Capture Utility
Program
- This publication is a reference manual designed to assist you in implementing data entry applications using the IBM 1288 Optical Page Reader. The data must be printed or typed in either USASCSOCR size A or ISO OCR-A size 1 font in the unformatted mode.
- This manual describes the control and functions of the 1288 Basic Unformatted Read System, which include:
- Input and output.
 - Error handling routines.
 - Job control language.
- The program operates under the IBM System/360 Operating System with primary control program (PCP), multi-programming with a fixed number of tasks (MFT), or multi-programming with a variable number of tasks (MVT) supervisor design. (34 pages)
- GC21-5019 IBM System/360 Disk 32**
Operating System IBM 1288 Basic
Unformatted Read System: A Data
Capture Utility Program
- Program Number: 5736-UT1 PPS*
- The 1288 Basic Unformatted Read System program is designed to assist you in entering data from the IBM 1288 Optical Page Reader, Model 1. It uses the ability of the 1288 to read unformatted, typed documents. The data contained on the documents is read, edited, and written on one of two sequential output files. (1 page)
- GC21-5020 IBM System/360 Operating 32**
System IBM 1288 Basic Unformatted
Read System 5734-UT3
- This program Product Specifications (PPS) describes the warranted specifications of the subject Program Product. (2 pages)
- GC21-9040 IBM System/360 Basic 25**
Programming Support Specifications
FORTRAN IV, (16K Card)
- This publication describes and illustrates the use of the Basic Programming Support Card FORTRAN IV language for the IBM System/360. The reader is presumed to have some knowledge of an existing FORTRAN language.
- The Basic Programming Support FORTRAN IV language is a symbolic programming language. It parallels the symbolism and format of mathematical notation. In addition, many programming features and facilities are available for expressing the method of solution of a mathematical problem as a meaningful FORTRAN program. (52 pages)
- GC22-6820 IBM System/360 Installa- 15**
tion Manual—Physical Planning
- This manual contains preliminary physical information for installing IBM System/360, including floor planning and electrical, environmental, and structural requirements. It discusses the physical characteristics of each unit and their effect on installation requirements. Detailed cable and location charts are included, together with illustrations and dimensions, on all cable connectors used in the system. (169 pages)

GC22-6922 IBM 2911 Models 1, 2, and 5 and IBM 2989 Model 8 Installation Manual—Physical Planning 15

This bulletin contains all physical planning data necessary to install the IBM 2911 Manual Switching Unit Models 1, 2, and 5 and the IBM 2989 Remote Switching Console Model 8. If a unit is to be installed in conjunction with a computer system, specifications for the most critical unit must be met.

Data follows the same format and uses the same standardized symbols as *IBM System/360 Installation Manual—Physical Planning*, Order Number GC22-6820. (8 pages)

GC24-3320 IBM System/360 Basic Programming Support Specifications Sort/Merge Programs (8K Tape) 33

This publication describes the IBM System/360 Basic Programming Support 8K Tape Sort/Merge Programs (one channel and two channel). It contains the following information: 1. Minimum machine requirements for sorting or merging records with this program. 2. Program capabilities. 3. A description of the control statements required to define specific sort or merge operations. 4. A description of the facilities provided for inserting user-written routines into the program. (72 pages)

GC24-3321 IBM System/360 Basic Operating System—Sort/Merge Program 33

This publication describes the IBM Basic Operating System/360 8K Disk Sort/Merge Program. It contains the following information:

1. Minimum machine requirements for sorting or merging records with this program.
2. Program capabilities.
3. A description of the control statements required to define specific sort or merge operations.
4. A description of the facilities provided for inserting user-written routines into the program. (43 pages)

GC24-3337 IBM System/360 Operating System Report Program Generator Language 28

This reference publication contains fundamentals of RPG programming and language specifications for the IBM System/360 Operating System, Report Program Generator.

Also included is the job setup information for executing RPG. (145 pages)

GC24-3343 IBM System/360 Basic Programming Support—Autotest Specifications (8K Tape) 37

This reference publication describes in detail the testing services provided by the Basic Programming

Support BPS Tape Autotest (8K Tape) program and the control cards necessary to use the services. Although one of the 8K Tape BPS programs, Autotest requires at least 16K positions of main storage for execution. The following features are described: Autopatch, display, panel, card list, Autotest Output Tape, the Autotest Card-to-Tape utility, the Autotest Tape-to-Printer utility, normal and abnormal dumps, and disaster continue. Special Autotest requirements of Job Control are also presented.

The reader should be familiar with *IBM System/360 Principles of Operation*, Order Number GA22-6821 and *IBM System/360 Basic Programming Support Programmer's Guide (8K Tape)*, Order Number GC24-3354. (54 pages)

GC24-3345 IBM 1401/1460 Timing Programs for IBM System/360 Basic Programming Support Sort/Merge Programs (8K Tape) 33

Program Numbers:

1401-LM-078, Version 2 (2401-2404)

1401-LM-080, Version 1 (2415)

This publication contains the specifications and operating procedures for the IBM 1401 and 1460 timing programs used to estimate the amount of time required to sort records with an IBM System/360 Basic Programming Support 1-channel or 2-channel Sort/Merge Program (8K Tape).

The following information is included in this publication:

1. Minimum machine requirements for estimating times with these programs.
2. A description of the user-prepared information cards required to define the proposed sort operation.
3. The procedure to follow for executing the timing programs.

The user of this publication should be familiar with *IBM System/360 Basic Programming Support Sort/Merge Program (8K Tape)*, Order Number GC24-3320. For a list of associated 1401/1460 publications, see the *IBM 1401/1460 Bibliography*, Order Number GA24-1495. For a list of associated System/360 publications, see the *IBM System/360 Bibliography*, Order Number GA22-6822. (16 pages)

GC24-3354 IBM System/360 Basic Programming Support—Basic Tape System Programmer's Guide 20

This reference publication describes the Basic Tape System and its use. The reader should have a basic knowledge of System/360. The major topics explained are:

Operation with the Control Programs: Supervisor interruption handling, operator communication, the Channel Scheduler, and the communication region; Job Control card formats and symbolic I/O assignment; IPL and the Program Loader.

Input/Output Control System (IOCS): Labels, file and record processing.

Basic Tape System: Job Control with the System Tape, assembly of a Supervisor, Linkage Editor, and System Tape building, maintenance, and service.

Titles and abstracts of related publications are listed in the *IBM System/360 Bibliography*, Order Number GA22-6822. (168 pages)

GC24-3355 IBM System/360 Basic Programming Support—Assembler with Input/Output Macros (Tape) Specifications 21

This reference publication describes the basic programming support tape assembler language and the input/output (I/O) macros supplied by IBM for use in programs written in the assembler language. The general features of the assembler language are described first, followed by a description of each of the three types of assembler language statements: machine-instruction, assembler-instruction, and macro-instruction statements. The description of macro instructions consists of a description of each of the 13M-supplied I/O macros.

The reader should be familiar with the information presented in the publications: *IBM System/360 Principles of Operation*, Order Number GA22-6821; *IBM System/360 Basic Programming Support, Programmer's Guide*, Order Number GC24-3354; and *IBM System/360 Basic Operating System and IBM System/360 Basic Programming Support, Macro Definition Language*, Order Number GC24-3364. For a list of associated publications see the *IBM System/360 Bibliography*, Order Number GA22-6822. (232 pages)

GC24-3361 IBM System/360 Basic Operating System—Assembler with Input/Output Macros Specifications 21

This reference publication describes the assembler language and the input/output (I/O) macros supplied by IBM for use in writing programs for 8K disk-oriented System/360 installations. The general features of the assembler language are described first, followed by a description of each of three types of assembler language statements: machine-instruction, assembler-instruction, and macro-instruction statements. The description of the macro instructions consists of a description of each of the IBM-supplied I/O macros.

The reader should be familiar with the information presented in the publications:

IBM System/360 Principles of Operation, Order Number GA22-6821

IBM System/360 Basic Operating System, Programmer's Guide, Order Number GC24-3372

IBM System/360 Basic Operating System and IBM System/360 Basic Programming Support, Macro Definition Language, Order Number GC24-3364

For a list of other associated publications, refer to the *IBM System/360 Bibliography*, Order Number GA22-6822. (280 pages)

GC24-3363 IBM System/360 Basic 32
Programming Support—DASD Utility
Programs Specifications

This reference publication describes the IBM System/360 Basic Programming Support Direct Access Storage Device Utility Programs. The programs described are:

PROGRAM NAME	ORDER NUMBER
<i>Single-Transfer Utility Programs</i>	
Card to Disk, Version 3	360P-UT-063
Disk to Card, Version 3	360P-UT-064
Disk to Disk, Version 3	360P-UT-067
Disk to Printer, Version 3	360P-UT-073
Disk to Tape, Version 3	360P-UT-065
Tape to Disk, Version 3	360P-UT-066
<i>Special-Purpose Utility Programs</i>	
Alternate Track Assignment (2311), Version 3	360P-UT-098
16K Alternate Track Assignment (2311/2314), Version 1	360P-UT-207
Alternate Track Assignment (2321), Version 1	360P-UT-212
Clear Disk, Version 3	360P-UT-068
Copy Data Cell to Tape, and Restore Tape to Data Cell, Version 1	360P-UT-071
Copy Disk to Card, and Restore Card to Disk, Version 1	360P-UT-062
Copy Disk to Disk, Version 1	360P-UT-072
Copy Disk to Tape, and Restore Tape to Disk, Version 1	360P-UT-061
Initialize Data Cell, Version 1	360P-UT-204
Initialize Disk (2311), Version 4	360P-UT-069
16K Initialize Disk (2311/2314), Version 1	360P-UT-206
Multiple Disk to Printer, Version 2	360P-UT-203

These programs can be received by ordering individually numbered program packages. Each program is shipped as a complete entity, in object form, ready to perform its function. Other BPS Utility Programs have been reissued in the publication: *IBM System/360 Basic Programming Support, Card and Tape Utility Programs Specifications*, GC24-5026. These publications support only the latest version of the program.

The reader should be familiar with the information presented in the publications: *IBM System/360 Basic Operating System, Programmer's Guide*, GC24-3372 and *IBM System/360 Basic Programming Support DASD Utility Program Operating Guide*, GC24-3392. For a list of associated publications, refer to the *IBM System/360 Bibliography*, GA22-6822. (80 pages)

GC24-3364 IBM System/360 Basic 21
Programming Support, Basic Operating
System—Macro Definition Language
(8K Tape)

This reference publication describes the macro definition language for the IBM Basic Operating System/360 (8K Disk) and the IBM System/360 Basic Programming Support (8K Tape). The language described in this publication can be used to facilitate the writing of an assembler language program.

The reader should be familiar with the information presented in these publications: *IBM System/360 Principles of Operation*, Order Number GA22-6821; *IBM Basic Operating System/360 Assembler with Input/Output Macros (8K Disk)*, Order Number GC24-3361; and *IBM System/360 Basic Programming Support Assembler with Input/Output Macros (8K Tape)*, Order Number GC24-3355. (45 pages)

GC24-3372 IBM System/360 Basic 20
Operating System—Programmer's
Guide

This reference publication describes the IBM System/360 Basic Operating System. The system is a set of control programs and processing programs provided for smaller configurations of the IBM System/360. Utilizing IBM 2311 Disk Storage for on-line program residence, IBM System/360 Basic Operating System provides stacked-job processing capability, controls all input/output, and provides for continuous operation of all programs run in its environment.

This Programmer's Guide includes descriptions of the control programs, service programs, and system facilities supported by IBM. A comprehensive introduction gives an over-all picture of the entire system. Detailed information is given on these major topics:

1. Operation with the System Control Programs
2. Using the System Service Programs
3. Data Management

The prerequisite for a thorough understanding of this manual is a basic knowledge of System/360 machine concepts and instructions.

For titles and abstracts of other associated publications see the *IBM System/360 Bibliography*, Order Number GA22-6822. (174 pages)

GC24-3374 IBM System/360 Basic Pro- 28
gramming Support Specifications—
Report Program Generator (Card)

This reference publication contains complete programming specifications for the IBM System/360 Report Program Generator (Card). Included are the basic functions of RPG for readers with unit record experience who are not familiar with RPG. (110 pages)

GC24-3377 IBM System/360 Basic 33
Operating System—IBM 1401/1460
Timing Program for Sort/Merge
Program

This publication contains the specifications and operating procedures for the IBM 1401 and 1460 timing program used to estimate the amount of time required to sort records with the IBM Basic Operating System/360 8K Disk Sort/Merge program.

The following information is included in this publication:

1. Minimum machine requirements for estimating times with this program.
2. A description of the user-prepared information cards required to define the proposed sort operation.

3. The procedure to follow for executing the timing program.

The user of this publication should be familiar with *IBM Basic Operating System/360 Sort/Merge Program (8K Disk)*, Order Number GC24-3321. For a list of associated 1401/1460 publications, see *IBM 1401/1460 Bibliography*, Order Number GA24-1495. (13 pages)

GC24-3378 IBM System/360 Basic 37
Operating System Specifications—
Autotest

This reference publication describes in detail the testing services provided by Disk Autotest in the Basic Operating System—8K Disk and the control cards necessary to use the services. The following services are discussed: autopatch, display, panel, the autotest card to tape (variable) utility, the normal and abnormal end of job dumps including the symbolic dump, testing immediately following an assembly, and separate assemblies and tests. Special autotest requirements for job control are also presented.

The reader should be familiar with *IBM System/360 Principles of Operation*, Order Number GA22-6821; *IBM Basic Operating System/360 Programmer's Guide (8K Disk)*, Order Number GC24-3372; *IBM Basic Operating System/360 Utility Programs (8K Disk)*, Order Number GC24-3409; and *IBM Basic Operating System/360 Assembler with Input/Output Macros (8K Disk)*, Order Number GC24-3361. (110 pages)

GC24-3387 IBM System/360 Basic 28
Operating System Specifications—
Report Program Generator
Language

This reference publication contains fundamentals of RPG programming and language specifications for the IBM Basic Operating System/360 Report Program Generator. For information on the Basic Operating System that is beyond the purpose of this language publication, see *IBM Basic Operating System/360 Programmer's Guide (8K Disk)*, Order Number GC24-3372. (153 pages)

GC24-3391 IBM System/360 Basic 20
Programming Support Basic Tape System
Operating Guide

Program Number: 360P-AS-091
RPG Program Number: 360P-RG-201

This reference publication discusses briefly the overall concepts of using the various programs in the Basic Tape System. It describes the function and operation of the Control Programs used in conjunction with the IBM-supplied system tape or user's object program. A section listing messages provided by the programs or routines is included. System/operator communication is discussed, and a section of reference charts for System/360 coding is also included.

Each individual program section gives the specific operating procedure for that particular program, supplying information such as: description of card decks, and procedures to be followed.

Refer to the SRL publication *IBM System/360 Model 30 Operator's Guide*, Order Number GA24-3373, for information about the operation of the System/360. For a list of other associated System/360 publications, see the *IBM System/360 Bibliography*, Order Number GA22-6822. (120 pages)

GC24-3392 IBM System/360 Basic 32
Programming Support DASD Utility Programs Operating Guide

This publication is intended to be used as a guide in operating the following direct access storage device (DASD) utility programs:

PROGRAM NAME	ORDER NUMBER
<i>Single-Transfer Utility Programs</i>	
Card to Disk, Version 3	360P-UT-063
Disk to Card, Version 3	360P-UT-064
Disk to Disk, Version 3	360P-UT-067
Disk to Printer, Version 3	360P-UT-073
Disk to Tape, Version 3	360P-UT-065
Tape to Disk, Version 3	360P-UT-066
<i>Special Purpose Utility Programs</i>	
Alternate Track Assignment (2311), Version 3	360P-UT-098
16K Alternate Track Assignment (2311/2314), Version 1	360P-UT-207
Alternate Track Assignment (2321), Version 1	360P-UT-212
Clear Disk, Version 3	360P-UT-068
Copy Data Cell to Tape, and Restore Tape to Data Cell, Version 1	360P-UT-071
Copy Disk to Card, and Restore Card to Disk, Version 1	360P-UT-062
Copy Disk to Disk, Version 1	360P-UT-072
Copy Disk to Tape, and Restore Tape to Disk, Version 1	360P-UT-061
Initialize Data Cell, Version 1	360P-UT-204
Initialize Disk (2311), Version 4	360P-UT-069
16K Initialize Disk (2311/2314), Version 1	360P-UT-206
Multiple Disk to Printer, Version 2	360P-UT-203

These programs can be received by ordering individually numbered program packages. Each program is shipped as a complete entity, in object form, ready to perform its function. Other BPS utility programs have been reissued in the publication: *IBM System/360 Basic Programming Support, Card and Tape Utility Programs Operating Guide*, Order Number GC24-5027. These publications will support only the latest versions of the programs.

The reader should be familiar with the information presented in the publications: *IBM System/360 Basic Programming Support, DASD Utility Programs Specifications*, Order Number GC24-3363;

IBM System/360 Basic Operating System, Programmer's Guide, Order Number GC24-3372; and *IBM System/360 Principles of Operation*, Order Number GA22-6821. For a list of related publications, refer to the *IBM System/360 Bibliography*, Order Number GA22-6822. (70 pages)

GC24-3396 IBM System/360 Basic 32
Programming Support Universal Character Set Utility Program Operating Guide

Program Number: 360P-UT-048

This reference publication contains the Operating Guide for the Universal Character Set Utility Program used to load the read/write storage units in the IBM 2821 Control Unit. Included in the manual are a description of the UCS program deck, control cards, system and deck preparation, error waits and options, and operating instructions. An Appendix contains related information including standard train/chain arrangements and the Extended Binary Coded Decimal Interchange Code.

The user of this publication should be familiar with *IBM 2821 Control Unit*, Order Number GA24-3312 and *IBM 1403 Printer*, Order Number GA24-3073. For a list of associated System/360 publications, see the *IBM System/360 Bibliography*, Order Number GA22-6822. (24 pages)

GC24-3398 IBM System/360 Basic 30
Programming Support Input/Output 1412/1419 Specifications and Operating Guide

Program Number: 360P-IO-058

This reference publication describes programming specifications and operating procedures for the Input/Output control program supplied by IBM for System/360 applications using the IBM 1412 and 1419 Magnetic Character Readers. Detailed information is given on the programming required for all I/O operations on these devices as well as for other services of the control program. Also included are operator instructions and diagnostic messages.

The reader should be familiar with the following publications:

IBM System/360 Principles of Operation, Order Number GA22-6821
IBM System/360 Basic Programming Support, Basic Assembler Language, Order Number GC28-6503

IBM 1412 Magnetic Character Reader, Order Number GA24-1421, or
IBM 1219 Reader Sorter, IBM 1419 Magnetic Character Reader, Order Number GA24-1499. (*IBM 1419 Model 32 Magnetic Character Reader*, Order Number GA19-0004 and GA19-0023.)

IBM System/360 Model 30 Operator's Guide, Order Number GA24-3373

For information pertaining to Job Control cards, refer to either:

IBM System/360 Basic Operating System Programmer's Guide, Order Number GC24-3372.

Other related IBM publications are referenced by order number and briefly described in *IBM System/360 Bibliography*, Order Number GA22-6822. (56 pages)

GC24-3408 IBM System/360 Basic 30
Programming Support Input/Output 1231 Specifications and Operating Guide

Program Number: 360P-IO-060

This reference publication contains a description of the Input/Output program for the IBM 1231 Optical Mark Page Reader, and information concerning the instructions required to use the 1231 as an input device to an IBM System/360.

This reference publication also describes operating procedures for the Input/Output 1231 program. This program is used with the IBM 1231 Optical Mark Page Reader attached to an IBM System/360 Model 25, 30, 40, 50, or 65.

The reader should be familiar with the information presented in these publications: *IBM System/360 Principles of Operation*, Order Number GA22-6821, *IBM System/360 Basic Programming Support, Basic Tape System Programmer's Guide*, Order Number GC24-3354, and *IBM System/360 Basic Operating System Programmer's Guide*, Order Number GC24-3372. The publication *IBM 1231 N1 Optical Mark Page Reader*, Order Number GA21-9031, contains information that will be helpful to the 1231 programmer. For a complete list of associated System/360 publications, see the *IBM System/360 Bibliography*, Order Number GA22-6822. (48 pages)

GC24-3409 IBM System/360 Basic 32
Operating System Utility Programs Specifications

This reference publication describes the IBM System/360 Basic Operating System Utility Programs. The programs described are:

GROUP 1 Program Number	GROUP 2 Program Number
360B-UT-300 Card-to-Disk Program	360B-UT-301 Card-to-Tape Program
Card-to-Printer and/or Punch Program	Disk-to-Tape Program
Disk-to-Card Program	Tape-to-Card Program
Disk-to-Disk Program	Tape-to-Disk Program
Disk-to-Printer Program	Tape-to-Printer Program
Clear Disk Program	Tape-to-Tape Program
VTOC Display Program	Tape Compare Program

These programs are ordered by the above group program numbers and are distributed on the disk pack.

The reader should be familiar with the information presented in the publications *IBM System/360 Basic Operating System, Programmer's Guide*, Order Number GC24-3372, *IBM System/360 Basic Operating System, Assembler with Input/Output Macros*, Order Number GC24-3361, *IBM System/360 Basic Operating System, Operating Guide: Control Programs and Assembler*, Order Number GC24-3450.

The reader will find error messages for these utility programs in *IBM System/360 Basic Operating System, Operating Guide: Operator Messages*, Order Number GC24-5024.

For a list of related publications refer to the *IBM System/360 Bibliography*, Order Number GA22-6822. (68 pages)

GC24-3413 IBM System/360 Basic 33
Programming Support Operating Guide—Sort/Merge Programs (8K Tape)

Program Numbers:

360P-SM-043 (one-channel)
 360-SM-044 (two-channel)

This reference publication contains the following information: 1. The minimum machine requirements for sorting or merging records with the 8K Tape Sort/Merge Program, 2. A description of the program packages, 3. A description of the procedure to follow when modifying the program decks, 4. The instructions for running on 8K Tape Sort/Merge Program, 5. The programmed messages that can occur while the program is being run. (26 pages)

GC24-3414 IBM System/360 Disk 21
and Tape Operating Systems Assembler Language

This reference publication contains specifications for the IBM System/360 Disk and Tape Operating Systems Assembler Language (including macro instructions and conditional assembly facilities).

The assembler language is a symbolic programming language used to write programs for the IBM System/360. The language provides a convenient means for representing the machine instructions and related data necessary to program the IBM System/360. The IBM System/360 Disk and Tape Operating Systems Assembler Programs process the language and provide auxiliary functions useful in the preparation and documentation of a program, and include facilities for processing macro instructions.

Part 1 of this publication is an introduction to the assembler language.

Part 2 describes the basic functions of the assembler language.

Part 3 describes the conditional assembly and macro facilities in the assembler language. (144 pages)

GC24-3417 IBM System/360 Basic 37
Programming Support Operating Guide—Autotest

This reference publication contains information the operator must know to test an object program

using the 8K Tape Autotest Program. Autotest can be executed only on a machine with a minimum of 16K positions of main storage.

The reader should be familiar with the IBM System/360 publications: *IBM System/360 Basic Programming Support Autotest (8K Tape)*, Order Number GC24-3343; *IBM System/360 Basic Programming Support Operating Guide: Basic Tape System (8K)*, Order Number GC24-3391; and *IBM System/360 Model 30 Operators Guide*, Order Number GA24-3373. (16 pages)

GC24-3418 IBM System/360 Basic 28
Programming Support Report Program Generator Language Specifications (8K Tape)

This reference publication contains complete programming specifications for the IBM System/360 Report Program Generator (8K Tape). Included are the basic functions of RPG for readers with tape experience who are not familiar with RPG. For more detailed information regarding the generation of system tapes and input/output facilities provided, refer to the publication *IBM System/360 Basic Programming Support Programmer's Guide (8K Tape)*, Order Number GC24-3354. (137 pages)

GC24-3420 IBM System/360 Basic 20
Programming Support, Basic Operating System, Tape Operating System, and Disk Operating System—Programming Systems Summary

This publication provides a general description of the functions, capabilities, and applications of programming support for IBM System/360 with 8K, 16K, 24K, and 32K main storage. Basic Programming Support consists of programs and programming aids for small card and tape configurations. Basic Operating System is an 8K disk-resident system that provides greater capabilities. Tape Operating System and Disk Operating System are, respectively, tape-resident and disk-resident systems requiring at least 16K main storage, but providing additional facilities beyond those of Basic Operating System. With additional main storage, these latter systems also provide multiprogramming and telecommunications facilities.

For a list of associated publications and their abstracts, refer to the *IBM System/360 Bibliography*, Order Number GA22-6822. (52 pages)

GC24-3427 IBM System/360 Disk 30
Operating System Data Management Concepts

This reference publication contains a discussion of the data management facilities inherent in the Disk Operating System. It describes the file formats, labeling procedures, and access methods available with the system. There is also a general section describing the design of the direct-access storage devices supported.

The following publications are recommended as prerequisite readings: *IBM System/360 Principles of Operation*, Order Number GA22-6821, and *IBM System/360 Disk Operating System, System Control and System Service Programs*, Order Number GC24-5036.

Other related publications are: *IBM System/360 Disk Operating System Supervisor and Input/Output Macros*, Order Number GC24-5037, *IBM System/360 Disk and Tape Operating Systems Assembler Specifications*, Order Number GC24-3414, and *Glossary for Information Processing*, Order Number GC20-8089.

For a List of associated System/360 publications, refer to *IBM System/360 Bibliography*, Order Number GA22-6822. (68 pages)

GC24-3430 IBM System/360 Tape 30
Operating System—Data Management Concepts

This reference publication contains a discussion of the data management facilities inherent in the Tape Operating System. It describes the Input/Output Control System (IOCS), the file formats, and the labeling procedures available with the system.

The following publications are recommended as prerequisite readings:

IBM System/360 Principles of Operation, Order Number GA22-6821

IBM System/360 Tape Operating System, System Control and System Service Programs, Order Number GC24-5034

Other related publications are:

IBM System/360 Tape Operating System, Supervisor and Input/Output Macros, Order Number GC24-5035

IBM System/360 Disk and Tape Operating Systems, Assembler Specifications, Order Number GC24-3414

Glossary for Information Processing, Order Number GC20-8089

For a list of associated publications, see the *IBM System/360 Bibliography*, Order Number GA22-6822. (36 pages)

GC24-3433 IBM System/360 Disk 24
and Tape Operating Systems COBOL Language Specifications

Program Numbers:

360N-CB-452 (COBOL DOS)

360M-CB-402 (COBOL TOS)

COBOL (Common Business Oriented Language) is a programming language, similar to English, that is used for commercial data processing. It was developed by the Conference of Data Systems Languages (CODASYL).

This publication provides the programmer with rules for writing programs in COBOL for IBM System/360 Disk and Tape Operating Systems. Users unacquainted with COBOL should read the programmed instruction textbook *COBOL Program Fundamentals*, Order Number SR29-0205, with its reference handbook, Order Number SR29-0206.

The titles and abstracts of related publications are listed in the *IBM System/360 Bibliography*, Order Number GA22-6822. (140 pages)

IBM System/360 Tape Operating System, Performance Estimates, Order Number GC24-5020

IBM System/360 Tape Operating Systems, System Control and System Service Programs, Order Number GC24-3431.

(65 pages)

These and other IBM publications, along with a brief description of the content of each, are listed in the *IBM System/360 Bibliography*, Order Number GA22-6822. (105 pages)

GC24-3437 IBM System/360 Basic 30
Programming Support Input/Output
1418/1428 Specifications and
Operating Guide

Program Number: 360P-IO-059

This publication describes the input/output 1418/1428 program (I/O 1418/1428 Program) supplied by IBM for System/360 applications using the IBM 1418 or 1428 Optical Character Readers. The I/O 1418/1428 Program provides complete interruption-handling capability, controls all input/output, and controls a document buffer for maximum throughput. This reference publication also describes operating procedures for the Input/Output 1418/1428 program.

The reader should be familiar with the information presented in the following publications:

IBM System/360 Principles of Operation, Order Number GA22-6821

IBM System/360 Basic Programming Support, Basic Assembler and Basic Utility Programs (Card) Specifications and Operating Guide, Order Number GC28-6503

IBM 1418 Optical Reader, IBM 1428 Alpha-meric Optical Reader, Order Number GA24-1473

IBM System/360 Model 30 Operator's Guide, Order Number GA24-3373

For information pertaining to job control cards, refer to either publication:

IBM System/360 Basic Programming Support, Programmer's Guide, Order Number GC24-3354, or

IBM System/360 Basic Operating System, Programmer's Guide, Order Number GC24-3372

Other related IBM publications are referenced by form number and briefly described in *IBM System/360 Bibliography*, Order Number GA22-6822. (62 pages)

GC24-3438 IBM System/360 Disk 33
and Tape Operating Systems Tape
Sort/Merge Program—Specifications

Program Numbers:

360M-SM-400

360N-SM-400

This publication explains the following:

1. Minimum machine requirements.
2. Program capabilities.
3. Required control statements.
4. User-written routines.

The reader should be familiar with these publications:

IBM System/360 Tape Operating System, Data Management Concepts, Order Number GC24-3430

IBM 1401/1460 Timing Programs for IBM System/360 Disk and Tape Operating System, Tape Sort/Merge Program, Order Number GC24-3439

GC24-3439 IBM 1401/1460 Timing 33
Program for IBM System/360 Disk
and Tape Operating Systems Tape
Sort/Merge Program

Program Numbers:

1401-LM-010 (2401-2404)

1401-LM-012 (2415)

This publication contains the specifications and operating procedures for the IBM 1401 and 1460 timing program used to estimate the amount of time required to sort tape records with the IBM System/360 Disk Operating System Tape Sort/Merge program or the IBM System/360 Tape Operating System Tape Sort/Merge Program.

The following information is included in this publication:

1. Minimum machine requirements for estimating times with these programs.
2. A description of the user-prepared information cards required to define the proposed sort operation.
3. The procedure to follow for executing the timing program.

The user of this publication should be familiar with *IBM System/360 Disk and Tape Operating Systems, Tape Sort/Merge Program Specifications*, Order Number GC24-3438. For a list of associated 1401/1460 publications, see the *IBM 1401/1460 Bibliography*, Order Number GA24-1495. For a list of associated System/360 publications, see the *IBM System/360 Bibliography*, Order Number GA22-6822. (16 pages)

GC24-3441 IBM System/360 Tape 37
Operating System—Autotest
Specifications

This reference publication describes the testing services provided by the IBM System/360 Tape Operating System Autotest program. Programmer-oriented diagnostic messages are included in this publication, as well as formats and examples of control cards for both job control and Autotest.

Refer to the following IBM System/360 publications for related information:

Principles of Operation, Order Number GA22-6821

Disk and Tape Operating Systems Assembler/Specifications, Order Number GC24-3414

Disk and Tape Operating Systems Utility Programs Specifications, Order Number GC24-3465

Tape Operating System, System Control and System Service Programs, Order Number GC24-3431

Tape Operating System Operating Guide, Order Number GC24-5021

GC24-3444 IBM System/360 Disk 33
Operating System Sort/Merge Program
Specifications

Program Number: 360N-SM-450

This publication describes the IBM System/360 Disk Operating System Sort/Merge Program and contains the following information:

1. Minimum machine requirements for sorting or merging records with this program.
2. Program capabilities.
3. A description of the control statements required to define specific sort or merge operations.
4. A description of the facilities provided for inserting user-written routines into the program.

The following publications are prerequisites: *IBM System/360 Disk Operating System, Data Management Concepts*, Order Number GC24-3427

IBM System/360 Disk Operating System, System Control and System Service Programs, Order Number GC24-5036

IBM System/360 Disk Operating System, Supervisor and Input/Output Macros, Order Number GC24-5037.

IBM System/360 Disk Operating System, System Generation and Maintenance, Order Number GC24-5033.

For a list of associated publications and their abstracts, see the *IBM System/360 Bibliography*, Order Number GA22-6822. (76 pages)

GC24-3445 IBM 1401/1460 Timing 33
Program for IBM System/360 Disk
Operating System Sort/Merge
Program

Program Number: 1401-LM-011

This publication contains the specifications and operating procedures for the IBM 1401 and 1460 timing program used to estimate the amount of time required to sort records with the IBM System/360 Disk Operating System Sort/Merge program.

The following information is included in this publication:

1. Minimum machine requirements for estimating times with this program.
2. A description of the user-prepared information cards required to define the proposed sort operation.
3. The procedure to follow for executing the timing program.

The user of this publication should be familiar with *IBM System/360 Disk Operating System, Sort/Merge Program Specifications*, GC24-3444. For a list of associated 1401/1460 publications, see *IBM 1401/1460 Bibliography*, GA24-1495. For a list of associated System/360 publications, see *IBM System/360 Bibliography*, GA22-6822. (16 pages)

GC24-3450 IBM System/360 Basic 20
Operating System Operating Guide

Program Numbers:

<i>Basic Control Program</i>	<i>360B-CL-302</i>
<i>Consecutive Processing Macros</i>	<i>360B-IO-303</i>
<i>Indexed Sequential File Management System (ISFMS)</i>	
<i>Macros</i>	<i>360B-IO-304</i>
<i>Direct Access Method (DAM)</i>	
<i>Macros</i>	<i>360B-IO-305</i>
<i>Assembler</i>	<i>360B-AS-309</i>
<i>Autotest</i>	<i>360B-PT-306</i>
<i>Report Program Generator (RPG)</i>	<i>360B-RG-307</i>
<i>Sort/Merge</i>	<i>360B-SM-308</i>
	<i>360B-UT-300</i>
	<i>360B-UT-301</i>

Utility Programs

This publication is divided into five sections:

Section 1 presents the operating procedures for the IBM System/360 Basic Operating System Control Programs and Assembler.

Section 2 presents the operating procedures for testing an object program using the IBM System/360 BOS Autotest program.

Section 3 presents the operating procedures for programs written in the IBM System/360 BOS Report Program Generator (RPG) language.

Section 4 presents the operating procedures for using the IBM System/360 BOS Sort/Merge program and a description of the procedure to follow when cataloging the BOS Sort/Merge program and user routines into the disk-resident core-image library.

Section 5 presents the operating procedures for both groups of utility programs in the IBM System/360 Basic Operating System.

For information about the operation of the System/360, see *IBM System/360 Model 30 Operator's Guide*, Order Number GA24-3373. For other related publications, see *IBM System/360 Bibliography*, Order Number GA22-6822. (170 pages)

GC24-3464 IBM System/360 Basic 28
Programming Support Operating Guide—Report Program Generator (Card)

This reference publication describes the operating procedures for the IBM System/360 Basic Programming Support, Report Program Generator (Card). It contains this information:

1. A description of the procedure to follow when using the Card RPG program to produce a variety of business reports.
2. The operating considerations for the Card RPG program.
3. The programmed messages that may be printed or displayed during generation or execution of the object program.

The publication *IBM System/360 Model 30 Operator's Guide*, Order Number GA24-3373, is a prerequisite. (28 pages)

GC24-3465 IBM System/360 Disk 32
and Tape Operating Systems Utility Programs Specifications

This reference publication describes the IBM System/360 Disk and Tape Operating Systems

Utility Programs. The programs described are:

<i>360N-UT-461</i>	Assign Alternate Track-Disk	Disk to Card
	Card to Printer and/or Punch	Disk to Disk
	Card to Disk	Disk to Printer
	Clear Disk	Initialize Disk
	Copy-Disk to Disk	VTOC Display
	Copy and Restore-Disk to Card	
<i>360N-UT-462</i>	Card to Tape	Tape Compare
	Copy and Restore-Disk to Tape	Tape to Data Cell
	Data Cell to Tape	Tape to Disk
	Disk to Tape	Tape to Printer
	Tape to Card	Tape to Tape
<i>360N-UT-463</i>	Clear Data Cell	Data Cell to Printer
	Data Cell to Data Cell	Disk to Data Cell
	Data Cell to Disk	

The reader should be familiar with these IBM System/360 Disk and Tape Operating Systems publications: *IBM System/360 Tape Operating System, Supervisor and Input/Output Macros*, Order Number GC24-5035; *IBM System/360 Disk Operating System, Supervisor and Input/Output Macros*, Order Number GC24-5037; *IBM System/360 Tape Operating System, Data Management Concepts*, Order Number GC24-3430; *IBM System/360 Disk Operating System, Data Management Concepts*, Order Number GC24-3427; *IBM System/360 Tape Operating System, System Control and System Service Programs*, Order Number GC24-5034; *IBM System/360 Disk Operating System, System Control and System Service Programs*, Order Number GC24-5036.

For titles and abstracts of other associated publications, see the *IBM System/360 Bibliography*, Order Number GA22-6822. (140 pages)

GC24-5015 IBM System/360 31
Tape Operating System—System Generation and Maintenance

This reference publication contains specifications and operating procedures used to generate an installation-tailored Tape Operating System. Supervisor macro instructions are used to describe facilities that are required within the system. This publication also contains sample problems that can be used to test the generated system.

The following publications are useful references:

IBM System/360 Tape Operating System, System Control and System Service Programs, Order Number GC24-5034.

IBM System/360 Tape Operating System, Supervisor and Input/Output Macros, Order Number GC24-5035.

IBM System/360 Tape Operating System, Performance Estimates, Order Number GC24-5020.

IBM System/360 Disk and Tape Operating Systems, Utility Programs Specifications, Order Number GC24-3465.

IBM System/360 Tape Operating System, Operating Guide, Order Number GC24-5021.

IBM System/360 Basic Programming Support, Card and Tape Utility Programs Specifications, Order Number GC24-5026.

For titles and abstracts of other associated publications, see the *IBM System/360 Bibliography*, Order Number GA22-6822. (116 pages)

GC24-5020 IBM System/360 Tape 20
Operating System Performance Estimates

This reference publication contains main storage, external storage, and timing estimates for the Tape Operating System. The storage requirements are not sensitive to system configuration, but the timing estimates are. Therefore, representative system configurations are used to illustrate timing variances.

The timing discussion includes estimates for Job Control, Linkage Editor, Assembler, COBOL, FORTRAN, PL/I, and RPG. Time requirements for processing ATTN commands, foreground program initiation, and the task selection mechanism are included. Examples illustrate the use of the timing data to calculate total job time.

Related publications are:

IBM System/360 Tape Operating System, System Control and System Service Programs, Order Number GC24-5034.

IBM System/360 Tape Operating System, Supervisor and Input/Output Macros, Order Number GC24-5035.

IBM System/360 Tape Operating System, System Generation and Maintenance, Order Number GC24-5015.

For titles and abstracts of other associated publications, see the *IBM System/360 Bibliography*, Order Number GA22-6822. (68 pages)

GC24-5021 IBM System/360 Tape 20
Operating System—Operating Guide

Program Numbers:

<i>Assembler</i>	<i>360M-AS-465</i>
<i>COBOL</i>	<i>360M-CB-402</i>
<i>System Control and Basic IOCS</i>	<i>360M-CL-405</i>
<i>FORTRAN IV</i>	<i>360M-FO-409</i>
<i>PL/I</i>	<i>360M-PL-410</i>
<i>Consecutive Tape IOCS</i>	<i>360M-IO-404</i>
<i>Compiler I/O Modules</i>	<i>360M-IO-412</i>
<i>Optical Character Reader IOCS</i>	<i>360M-IO-417</i>
<i>Autotest</i>	<i>360M-PT-407</i>
<i>Report Program Generator (RPG)</i>	<i>360M-RG-408</i>
<i>Tape Sort/Merge</i>	<i>360M-SM-400</i>
<i>Supervisor (6K)</i>	<i>360M-SV-413</i>
<i>Supervisor (8K)</i>	<i>360M-SV-414</i>
<i>Utilities</i>	<i>360M-UT-403</i>
<i>MPS Utility Macros</i>	<i>360M-UT-411</i>

This reference publication describes the operating procedures to be followed when executing jobs in a multiprogramming environment using the Tape Operating System. Topics discussed in this publication include stacked-job processing capability, multiprogramming, and related functions the operator must perform to initiate system operation and communicate with the system. A quick reference listing of all system-to-operator messages is included.

For a description of the concepts of the Tape Operating System, see *IBM System/360 Disk and Tape Operating Systems Concepts and Facilities*, Order Number GC24-5030. Information concerning the operation of the System/360 can be found in *IBM System/360 Model 30 Operator's Guide*, Order Number GA24-3373, or a corresponding publication. For a list of other associated System/360 publications, see the *IBM System/360 Bibliography*, Order Number GA22-6822. (124 pages)

GC24-5022 IBM System/360 Disk 20
Operating System Operating Guide

Program Numbers:

<i>System Control and Basic IOCS</i>	360N-CL-453
<i>Supervisor (6K) 2311</i>	360N-SV-474
<i>Supervisor (8K) 2314</i>	360N-SV-486
<i>Direct Access Method (DAM) Macros</i>	360N-IO-454
<i>Consecutive Disk IOCS</i>	360N-IO-455
<i>Consecutive Tape IOCS</i>	360N-IO-456
<i>Indexed Sequential File Management System (ISFMS) Macros</i>	360N-IO-457
<i>Consecutive Paper Tape IOCS</i>	360N-IO-458
<i>Compiler I/O Modules</i>	360N-IO-476
<i>Magnetic Character Reader IOCS</i>	360N-IO-477
<i>Optical Character Reader IOCS</i>	360N-IO-478
<i>Group 1 Utilities (Disk and Unit Record)</i>	360N-UT-461
<i>Group 2 Utilities (Magnetic Tape)</i>	360N-UT-462
<i>Group 3 Utilities (Data Cell)</i>	360N-UT-463
<i>Multiprogramming Support Utility Macros</i>	360N-UT-471
<i>Vocabulary File Utility Program</i>	360N-UT-472
<i>Tape Sort/Merge</i>	360N-SM-400
<i>Disk Sort/Merge</i>	360N-SM-450
<i>Tape and Disk Sort/Merge Assembler</i>	360N-AS-465
<i>Assembler F</i>	360N-AS-466
<i>Report Program Generator</i>	360N-RG-460
<i>COBOL</i>	360N-CB-452
<i>COBOL and PL/I DASD Macros</i>	360N-CB-468
<i>Basic FORTRAN IV</i>	360N-FO-451
<i>FORTRAN IV</i>	360N-FO-479
<i>FORTRAN IV Library</i>	360N-LM-480
<i>Autotest</i>	360N-PT-459
<i>PL/I</i>	360N-PL-464
<i>Basic Telecommunications (BTAM)</i>	360N-CQ-469
<i>Queued Telecommunications (QTAM)</i>	360N-CQ-470
<i>1401/1440/1460 Emulator Program for Model 30</i>	360N-EU-484
<i>On-Line Test Executive Program (OLTEP)</i>	360N-DN-481

This reference publication describes the operating procedures to be followed when executing jobs in a multiprogramming environment using the Disk Operating System. Topics discussed include: stacked-job processing capability, multiprogramming, both basic and queued telecommunications capability, and functions the operator must perform to initiate

system operation and to communicate with the system. A quick reference listing of all system-to-operator messages is included.

For a list of associated publications, refer to the *IBM System/360 Bibliography*, Order Number GA22-6822. (208 pages)

GC24-5024 IBM System/360 Basic 20
Operating System Operator Messages

Program Numbers:

<i>Basic Control Program</i>	360B-CL-302
<i>Consecutive Processing Macros</i>	360B-IO-303
<i>Indexed Sequential File Management System (ISFMS) Macros</i>	360B-IO-304
<i>STR Macros</i>	360B-IO-310
<i>BSC Macros</i>	360B-CQ-312
<i>Utilities—Group I</i>	360B-UT-300
<i>Utilities—Group II</i>	360B-UT-301
<i>Sort/Merge</i>	360B-SM-308
<i>Assembler</i>	360B-AS-309
<i>Report Program Generator</i>	360B-RG-307
<i>Autotest</i>	360B-PT-306

This reference publication lists, in numeric and alphabetic order, all messages issued to the operator by the programs of the IBM System/360 Basic Operating System.

For a list of associated publications and their abstracts, see *IBM System/360 Bibliography*, Order Number GA22-6822. (92 pages)

GC24-5025 IBM System/360 Disk and 24
Tape Operating Systems COBOL Programmer's Guide

Program Numbers:

360N-CB-452
360N-CB-402

This publication describes how to compile, linkage edit, and execute a Disk and Tape COBOL program. The text also describes the output from each of these steps. In addition, it explains options of the compiler and many available features of the operating system. (216 pages)

GC24-5026 IBM System/360 Basic 32
Programming Support Specifications—Card and Tape Utility Programs

This reference publication describes the IBM System/360 Basic Programming Support Utility Programs. The programs described are:

Card to Printer and/or	
Punch	360P-UT-050, Version 2
Card to Tape	360P-UT-051, Version 2
Tape to Card	360P-UT-053, Version 2
Tape to Printer	360P-UT-052, Version 2
Tape to Tape	360P-UT-054, Version 2

The preceding programs can be received by ordering individually numbered program packages. Each program is shipped as a complete entity, in object form, ready to perform its function.

The reader should be familiar with the information presented in the publications: *IBM System/360 Basic Programming Support, Programmer's Guide (8K Tape)*, GC24-3354; *IBM System/360 Basic Programming Support Operating Guide: Card and Utility Programs*, Order Number GC24-5027. (48 pages)

GC24-5027 IBM System/360 Basic 32
Programming Support Card and Tape Utility Programs Operating Guide

This reference publication contains the guidelines to operate the following Card and Tape utility programs:

SINGLE-TRANSFER UTILITY PROGRAMS

Card to Printer and/or	
Punch	360P-UT-050, Version 3
Card to Tape	360P-UT-051, Version 3
Tape to Card	360P-UT-053, Version 3
Tape to Printer	360P-UT-052, Version 3
Tape to Tape	360P-UT-054, Version 3
SPECIAL-PURPOSE UTILITY PROGRAMS	
Initialize Tape	360P-UT-057, Version 3
Multiple Utility	360P-UT-055, Version 2
Storage Print	360P-UT-056, Version 1
Tape Compare	360P-UT-202, Version 1

These programs can be received by ordering individually numbered program packages. Each program is shipped as a complete entity, in object form, ready to perform its function.

The reader should be familiar with these IBM System/360 publications: *IBM System/360 Basic Programming Support Specifications: Utility Programs*, Order Number GC24-5026; *IBM System/360 Principles of Operation*, Order Number GA22-6821; and other manuals associated with his device configuration.

For a list of related publications and their abstracts, see the *IBM System/360 Bibliography*, Order Number GA22-6822. (44 pages)

GC24-5029 IBM System/360 24
Operating System COBOL (E) Programmer's Guide

Program Number: 360S-CO-503

This publication describes how to compile, linkage edit, and execute a COBOL (E) program. The text also describes the output from each of these steps. In addition, it explains options of the compiler and many available features of the operating system. (164 pages)

GC24-5030 IBM System/360 Disk and 20
Tape Operating Systems Concepts and Facilities

This reference publication describes the concepts of Disk and Tape Operating Systems and guides the planner in the use of their various facilities. It describes the components in the Disk and Tape Operating Systems and explains the function of each. The last section of the publication discusses the design, preparation and execution of programs.

For titles and abstracts of associated publications, see the *IBM System/360 Bibliography*, Order Number GA22-6822. (44 pages)

GC24-5032 IBM System/360 Disk 20
Operating System Timing Estimates

This reference publication contains timing estimates for the Disk Operating System. The timing estimates are sensitive to system configuration; therefore, representative system configurations illustrate timing variances.

The timing discussion includes estimates for Job Control, Linkage Editor, Assembler, Assembler F, COBOL, PL/I, Basic FORTRAN, FORTRAN, and RPG. Time requirements for processing ATTN routines, Single Program Initiation, and the task selection mechanism are included. Examples illustrate the use of the timing data to calculate total job time, exclusive of job execution time. (60 pages)

GC24-5033 IBM System/360 Disk 31
Operating System—System Generation and Maintenance

This reference publication contains specifications and operating procedures used to generate an installation-tailored Disk Operating System. Supervisor macro instructions describe facilities that are required within the system. This publication also contains sample problems that can be used to test the generated system.

The following publications are useful references:

IBM System/360 Disk Operating System, Operating Guide, Order Number GC24-5022.

IBM System/360 Disk Operating System, System Control and System Service Programs, Order Number GC24-5036.

IBM System/360 Disk Operating System, Supervisor and Input/Output Macros, Order Number GC24-5037.

IBM System/360 Disk Operating System, Timing Estimates, Order Number GC24-5032.

IBM System/360 Basic Programming Support, DASD Utility Programs Specifications, Order Number GC24-3363.

IBM System/360 Basic Programming Support, DASD Utility Programs Operating Guide, Order Number GC24-3392.

IBM System/360 Basic Programming Support, Distribution Program Specifications and Operating Guide, Order Number GC21-5001.

IBM System/360 Disk and Tape Operating Systems, Utility Programs Specifications, Order Number GC24-3465.

IBM System/360 Disk Operating System, Vocabulary File Utility Programs for IBM 7772 Audio Response Unit, Order Number GC27-6924.

For titles and abstracts of other associated publications, see the *IBM System/360 Bibliography*, Order Number GA22-6822. (356 pages)

GC24-5034 IBM System/360 Tape 36
Operating System—System Control and System Service Programs

This reference publication describes the IBM System/360 Tape Operating System. The system is a set of control programs and processing programs provided for the IBM System/360. Using IBM 2400-Series Magnetic Tape Units for on-line program

residence, IBM System/360 Tape Operating System provides stacked-job processing capability, multiprogramming capability, controls all input/output, and provides for continuous operation of all programs run in its environment. Detailed information is given in this publication on these major topics.

1. Operation with the System Control Program:
 - a. System Organization
 - b. Supervisor Functions
 - c. Job Control Program.

2. Using the System Service Programs:
 - a. Linkage Editor
 - b. Librarian.

The prerequisite for a thorough understanding of this publication is a basic knowledge of System/360 machine concepts. The publications most closely related to this one are:

IBM System/360 Principles of Operation, Order Number GA22-6821

IBM System/360 Tape Operating System: Data Management Concepts, Order Number GC24-3430

IBM System/360 Tape Operating System: Supervisor and Input/Output Macros, Order Number GC24-5035

IBM System/360 Disk and Tape Operating Systems: Assembler Specifications, Order Number GC24-3414. (124 pages)

GC24-5035 IBM System/360 Tape 30
Operating System—Supervisor and Input/Output Macros

This reference publication contains planning information about the Input/Output Control System macro instructions and the Supervisor macro instructions for use with IBM System/360 Tape Operating System (TOS), IBM publications that provide related information are:

IBM System/360 Principles of Operation, Order Number GA22-6821

IBM System/360 Tape Operating System, Data Management Concepts, Order Number GC24-3430

IBM System/360 Tape Operating System, System Control and System Service Programs, Order Number GC24-5034

IBM System/360 Disk and Tape Operating Systems, Assembler Specifications, Order Number GC24-3414

For titles and abstracts of other associated publications see *IBM System/360 Bibliography*, Order Number GA22-6822. (140 pages)

GC24-5036 IBM System/360 Disk 36
Operating System—System Control and System Service Programs

This reference publication describes the IBM System/360 Disk Operating System. The system is a set of control programs and processing programs provided for IBM System/360. Using IBM 2311 Disk Storage or IBM 2314 Direct Access Storage for on-line program residence, the IBM System/360 Disk Operating System provides stacked-job processing capability, multiprogramming and telecommunications capability, controls all input/output, and provides for continuous operation of all programs run in its environment.

Detailed information is given in this publication on these major topics.

1. Operation with the System Control Program:

- a. System Organization
- b. Supervisor Functions
- c. Job Control Program.

2. Using the System Service Programs:
 - a. Linkage Editor
 - b. Librarian.

The prerequisite for a thorough understanding of this publication is a basic knowledge of System/360 machine concepts. The publications most closely related to this one are:

IBM System/360 Principles of Operation, Order Number GA22-6821

IBM System/360 Disk Operating System, Data Management Concepts, Order Number GC24-3427

IBM System/360 Disk Operating System Supervisor and Input/Output Macros, Order Number GC24-5037

IBM System/360 Disk and Tape Operating Systems, Assembler Specifications, Order Number GC24-3414.

(168 pages)

GC24-5037 IBM System/360 Disk 30
Operating System Supervisor and Input/Output Macros

This reference publication describes the Input/Output Control System macro instructions and the Supervisor macro instructions for use with the IBM System/360 Disk Operating System (DOS). These macro instructions can be combined with problem programs to produce generalized or specific file processing programs for a foreground or background environment. Prerequisite information is contained in these publications:

IBM System/360 Principles of Operation, Order Number GA22-6821.

IBM System/360 Disk and Tape Operating System, Assembler Language, Order Number GC24-3414.

IBM System/360 Disk and Tape Operating System, Data Management Concepts, Order Number GC24-3427.

For titles and abstracts of the associated publications, see the *IBM System/360 Bibliography*, Order Number GA22-6822. (272 pages)

GC24-5038 IBM System/360 Disk and 25
Tape Operating Systems—Basic FORTRAN IV Programmer's Guide

Program Numbers:

360N-FO-451

360M-FO-409

This publication describes the procedures for compiling and executing FORTRAN IV programs under control of the Disk Operating System or Tape Operating System. Its purpose is to guide the programmer with examples and techniques of the Basic FORTRAN IV language. It also exposes the user to the components of the control program and facilities of the IBM System/360 Disk and Tape Operating Systems. (98 pages)

GC24-5039 IBM System/360 Disk Operating System—COBOL DASD Macros 24

This publication provides the programmer with rules for using DASD macros to handle input/output operations for direct access or indexed sequential files. The programmer should be familiar with:

COBOL: General Information Manual, Order Number GF28-8053

IBM System/360 Disk and Tape Operating System, COBOL Language Specifications, Order Number GC24-3433

IBM System/360 Disk Operating System, Data Management Concepts, Order Number GC24-3427

IBM System/360 Disk Operating System, Supervisor and Input/Output Macros, Order Number GC24-3429.

(24 pages)

GC24-5041 IBM System/360 Basic Operating System Master Index 20

This index is a consolidation of the indexes of all programming publications for the IBM Basic Operating System (BOS). Each index entry is accompanied by the abbreviated publication title, the subject code of the publication within the IBM System Reference Library, and the publication form number. Appendix A contains a list of the BOS publications, by title and form number, used to compile this consolidated index. Appendix B contains the publication plan for the Basic Operating System.

For a complete list of all IBM System/360 publications (machine manuals, all programming support, etc.) by order number and subject code, and with the abstract of each publication, see the *IBM System/360 Bibliography*, Order Number GA22-6822. (52 pages)

GC24-5042 IBM System/360 Disk and Tape Operating Systems Utility Macros Specifications 32

This reference publication describes Multiprogramming Support (MPS) Utility Macro Instructions for use with the Disk and Tape Operating Systems. These macro instructions can be combined with problem programs to produce generalized or specific file processing programs for use in the foreground or background environment.

Prerequisite information is contained in these publications:

IBM System/360 Principles of Operation, Order Number GA22-6821

IBM System/360 Disk and Tape Operating Systems, Assembler Language, Order Number GC24-3414.

Co-requisite information is contained in these publications:

IBM System/360 Disk Operating System, Supervisor and Input/Output Macros, Order Number GC24-5037.

IBM System/360 Tape Operating System, Supervisor and Input/Output Macros, Order Number GC24-5035.

For titles and abstracts of other associated publications, see the *IBM System/360 Bibliography*, Order Number GA22-6822. (60 pages)

GC24-5059 IBM System/360 Disk Operating System PL/I DASD Macros 29

This publication provides the programmer with rules for using DASD macros with the IBM 2311 Disk Storage Drive to handle input/output operations for indexed sequential files. The programmer should be familiar with these publications:

IBM System/360 Disk and Tape Operating Systems, PL/I Subset, Language Specifications, Order Number GC28-6809

IBM System/360 Disk and Tape Operating Systems, PL/I Programmer's Guide, Order Number GC24-9005

IBM System/360 Disk Operating System, Data Management Concepts, Order Number GC24-3427

IBM System/360 Disk, Operating System, Supervisor and Input/Output Macros, Order Number GC24-5037.

(15 pages)

GC24-5060 IBM System/360 Basic Operating System—System Generation and Maintenance 31

This reference publication contains specifications and operating procedures used to generate an installation-tailored Basic Operating System. Supervisor macro-instructions are used to define the facilities that are required within the system.

The following publications are useful references:

IBM System/360 Basic Operating System, Utility Programs Specifications, Order Number GC24-3409

IBM System/360 Basic Operating System, Programmer's Guide, Order Number GC24-3372

IBM System/360 Basic Operating System, Assembler with I/O Macros Specifications, Order Number GC24-3361

IBM System/360 Basic Operating System Operating Guide, Control Programs and Assembler, Order Number GC24-3450

For titles and abstracts of other associated publications, see the *IBM System/360 Bibliography*, Order Number GA22-6822. (80 pages)

GC24-5061 IBM System/360 Basic Programming Support, Basic Tape System, System Generation and Maintenance 31

This reference publication contains specifications and operating procedures for generating and maintaining a system tape for Basic Programming Support.

For additional information, refer to the following publications:

IBM System/360 Basic Programming Support, Basic Tape System, Programmer's Guide, Order Number GC24-3354

IBM System/360 Basic Programming Support, Basic Tape System Operating Guide, Order Number GC24-3391

IBM System/360 Basic Programming Support, Assembler with Input/Output Macros (Tape) Specifications, Order Number GC24-3355

IBM System/360 Basic Programming Support, Specifications: Card and Tape Utility Programs, Order Number GC24-5026

IBM System/360 Basic Programming Support, Operating Guide Card and Tape Utility Programs, Order Number GC24-5027

IBM System/360 Basic Programming Support, Report Program Generator (Tape) Specifications, Order Number GC24-3418

For titles and abstracts of other associated publications, see the *IBM System/360 Bibliography*, Order Number GA22-6822. (52 pages)

GC24-5062 IBM System/360 Disk Operating System—Autotest Specifications 37

This reference publication describes the testing services provided by the Disk Operating System Autotest. The following features are described: Autopatch, Test Request Options, normal and abnormal End of Job Dumps, Disaster Continue and the Autotest Card-to-Tape Variable program. Programmer-oriented diagnostic messages are also included. Control card formats and examples are given for Job Control as well as for Autotest.

The reader should be familiar with the following related publications:

IBM System/360 Principles of Operation, Order Number GA22-6821

IBM System/360 Disk and Tape Operating Systems Assembler Specifications, Order Number GC24-3414

IBM System/360 Disk Operating System System Control and System Service Programs, Order Number GC24-5036

IBM System/360 Disk Operating System Operating Guide, Order Number GC24-5022

IBM System/360 Disk Operating System System Generation and Maintenance, Order Number GC24-5033

IBM System/360 Disk and Tape Operating System Utility Programs Specifications, Order Number GC24-3465

For information regarding other related publications, see *IBM System/360 Bibliography*, Order Number GA22-6822.

(50 pages)

GC24-5063 IBM System/360 Disk Operating System—Master Index 20

This index is a consolidation of the indexes of all programming publications for the IBM Disk Operating System (DOS). Each index entry is accompanied by the abbreviated publication title, the subject code of the publication within the IBM System

Reference Library, and the publication form number. Appendix A contains a list of the DOS publications, by title and form number, used to compile this consolidated index. Appendix B contains the publication plan for the Disk Operating System.

For a complete list of all IBM System/360 publications (machine manuals, all programming support, etc.) by order number and subject code, and with the abstract of each publication, see the *IBM System/360 Bibliography*, Order Number GA22-6822. (132 pages)

GC24-5064 IBM System/360 Tape Operating System Programming Index 20

This index is a consolidation of the indexes of all programming publications for the IBM Tape Operating System (TOS). Each index entry is accompanied by the abbreviated publication title, and subject code of the publication within the IBM System Reference Library, and the publication form number. Appendix A contains a list of the TOS publications, by title and form number, used to compile this consolidated index. Appendix B contains the publication plan for the Tape Operating System.

For a complete list of all IBM System/360 publications (machine manuals, all programming support, etc.) by order number and subject code, and with the abstract of each publication, see the *IBM System/360 Bibliography*, Order Number GA22-6822. (75 pages)

GC24-5066 IBM System/360 Disk and Tape Operating Systems—On-Line Test Executive Program—Specifications and Operating Guide 37

Program Numbers:
DOS 360N-DN-481
TOS 360M-DN-418

This reference publication describes the On Line Test Executive Program that controls on line testing of I/O units under the Disk and Tape Operating Systems supervisors. It explains the functions of the program and gives procedures for running the test programs. The test programs are not described in this publication. Information about the test programs can be obtained from an IBM Field Engineering representative.

For titles and abstracts of associated publications see the *IBM System/360 Bibliography*, Order Number GA22-6822. (24 pages)

GC24-5067 IBM System/360 Basic Programming Support—Master Index 20

This index is a consolidation of the indexes of all programming publications for IBM System/360 Basic Programming Support (BPS). Each index

entry is accompanied by the abbreviated publication title, the subject code of the publication within the IBM Systems Reference Library, and the publication order number. Appendix A contains a list of the BPS publications, by title and order number, used to compile this consolidated index. Appendix B contains the publication plan for Basic Programming Support.

For a complete list of all IBM System/360 publications (machine manuals, all programming support, etc.) by order number and subject code, and with the abstract of each publication, see the *IBM System/360 Bibliography*, Order Number GA22-6822. (76 pages)

GC24-5069 IBM System/360 Basic Programming Support Modular File Maintenance Program Specifications and Operating Guide 32

Program Number: 360P-UT-219

This reference publication describes the specifications and operating procedures for the IBM System/360 Basic Programming Support Modular File Maintenance Program. This program builds and maintains a file of one or more modules, primarily source and/or object decks of programs, which may be revised whenever necessary.

Programmer-oriented diagnostic messages, as well as formats and examples of control statements for job control and the Modular File Maintenance Program, are included in this publication. An understanding of the IBM System/360 programming concepts is a prerequisite.

System/360 programming concepts are discussed in *IBM System/360 Principles of Operation*, Order Number GA22-6821.

Titles and abstracts of other related publications are listed in the *IBM System/360 Bibliography*, Order Number GA22-6822. (40 pages)

GC24-5070 IBM System/360 Basic Programming Support, Basic Operating System, Tape Operating System, and Disk Operating System—Tape Labels 30

The types of labels that may be written on magnetic tape by the System/360 are defined and described in this reference manual. The processing performed by the programming systems, and the specifications that the user must supply to the systems, are discussed in two major sections: one section for BPS and BOS processing, and another section for TOS and DOS processing. Each section discusses the processing of standard, user-standard, and non-standard labels, and unlabeled files. The discussion deals primarily with the functions performed for volume, header, and trailer labels when the user gives specifications directly to IOCS through DTF entries. In addition, a portion of each label processing section deals with the label processing specifications required by components of the system (such as Sort/Merge, Utilities, COBOL, etc.).

Illustrations of volume layouts depict the various arrangements of labels and data records that can be handled by the four programming systems. Flowcharts show the sequence of events that occur when files with standard, nonstandard, or no labels are opened and closed.

For a thorough understanding of this manual, the reader should have a basic knowledge of the Input/Output Control System (IOCS). The manuals that provide this information for each system are:

IBM System/360 Basic Programming Support, Assembler with Input/Output Macros (Tape) Specifications, Order Number GC24-3355.

IBM System/360 Basic Operating System, Assembler with Input/Output Macros Specifications, Order Number GC24-3361.

IBM System/360 Tape Operating System, Supervisor and Input/Output Macros, Order Number GC24-5035.

IBM System/360 Disk Operating System, Supervisor and Input/Output Macros, Order Number GC24-5037.

(144 pages)

GC24-5072 IBM System/360 Disk Operating System: DASD Labels 30

The types of labels that may be written on a Direct Access Storage Device (DASD) by the Disk Operating System are defined and described in this reference manual. The processing performed by the programming system, and the specifications that the user must supply to the system, are discussed in the second major section. This section discusses the processing of standard labels (volume, format-1, format-3) and user-standard labels for input/output sequential files and input/output direct access files. For indexed sequential files, the section discusses standard labels (volume format-1, format-2) under the load, add, and retrieve functions. The discussion deals primarily with the functions performed for the labels when the user gives specifications directly to IOCS through DTF entries.

In other sections, illustrations of volume layouts depict the various arrangements of labels and data records that can be handled by the Disk Operating System. The DASD labels supported by the programming system are described. Each label is illustrated, and each field of each label is described in detail. Flowcharts show the sequence of events for label processing when sequential, direct access, and indexed sequential files are opened and closed.

For a thorough understanding of this manual, the reader should have a basic knowledge of the Input/Output Control System (IOCS) as described in *IBM System/360 Disk Operating System, Supervisor and Input/Output Macros*, Order Number GC24-5037.

For a list of associated publications, refer to the *IBM System/360 Bibliography*, Order Number GA22-6822. (156 pages)

GC24-5073 IBM System/360 Disk Operating System: System Programmer's Guide 50

This reference publication is intended primarily for the system programmer who is involved in making decisions relating to the components of the installation's supervisor, file organization and program design. To form a single publication, this manual

brings together and expands upon information from many sources. Major topics discussed are:

1. Supervisor Planning Concepts
2. Data Management
3. Program Design
4. Debugging Aids

For each major section, the Preface lists the most closely related publications. For a complete list of available publications, see the *IBM System/360 Bibliography*, Order Number GA22-6822. (244 pages)

Messages, commands, and job control language enable the programmer and operator to control and maintain System/360 operation, providing direct communication between the system and the user.

For DOS operating information, see the companion publication, *IBM System/360 Disk Operating System Operating Guide*, Order Number GC24-5022.

For a list of associated publications, refer to the *IBM System/360 Bibliography*, Order Number GA22-6822. (176 pages)

2. Explain how to implement the functions.
3. Provide performance information.

The following manuals are prerequisites for the thorough understanding of this guide:

1. GC24-5036 - System Control-DOS.

(8 pages)

GC24-5074 IBM System/360 Disk 20
Operating System: Operator
Communications

Program Numbers:

System Control and Basic IOCS	360N-CL-453
Supervisor (6K) 2311	360N-SV-474
Supervisor (8K) 2314	360N-SV-486
Direct Access Method (DAM)	
Macros	360N-IO-454
Consecutive Disk IOCS	360N-IO-455
Consecutive Tape IOCS	360N-IO-456
Indexed Sequential File Management System (ISFMS) Macros	360N-IO-457
Consecutive Paper Tape IOCS	360N-IO-458
Compiler/IO Modules	360N-IO-476
Magnetic Character Reader IOCS	360N-IO-477
Optical Character Reader IOCS	360N-IO-478
Group 1 Utilities (Disk and Unit Record)	360N-UT-461
Group 2 Utilities (Magnetic Tape)	360N-UT-462
Group 3 Utilities (Data Cell)	360N-UT-463
Multiprogramming Support Utility Macros	360N-UT-471
Vocabulary File Utility Program	360N-UT-472
Tape Sort/Merge	360N-SM-400
Disk Sort/Merge	360N-SM-450
Tape and Disk Sort/Merge	360N-SM-483
Assembler	360N-AS-465
Assembler F	360N-AS-466
Report Program Generator	360N-RG-460
COBOL	360N-CB-452
COBOL F	360N-CB-482
COBOL LCP	360N-CV-498
COBOL and PL/I DASD Macros	360N-CB-468
Basic FORTRAN IV	360N-FO-451
FORTTRAN IV	360N-FO-479
FORTTRAN IV Library	360N-LM-480
Autotest	360N-PT-459
PL/I	360N-PL-464
Basic Telecommunications (BTAM)	360N-CQ-469
Queued Telecommunications (QTAM)	360N-CQ-470
1401/1440/1460 Emulator Program for Models 30, and 40	360N-EU-484
On-Line Test Executive Program (OLTEP)	360N-DN-481

This *reference* publication provides quick access information for operators and programmers who encounter System/360 DOS messages and use System/360 DOS commands and job control language.

GC24-5076 IBM System/360 OS 35
Program Planning Guide for the DOS
Emulator on IBM System/370
Model 155

Program Number: 360C-EU-738

The Disk Operating System (DOS) Emulator is integrated and executes as a problem program under an IBM System/360 Operating System (OS) having either an MFT or MVT control program. It provides for the execution of DOS programs in an OS environment. The Emulator may be multiprogrammed with other OS jobs, and it can run the multiprogramming options of DOS.

A description of the Emulator, specific information about program operation, control statement format and content, program generated messages, and a glossary of significant terms are included in this publication.

This information is intended for installation personnel who are responsible for selecting, evaluating, and implementing IBM System/360 Operating System configurations, who are experienced with OS and DOS, and who have working knowledge of the control programs involved and System/370 Model 155. Readers should be familiar with the publication *IBM System/360 Operating System Concepts and Facilities*, GC28-6535. For a list of associated publications, refer to the *IBM System/360 Bibliography*, GA22-6822. (40 pages)

GC24-5077 IBM System/360 20
Disk Operating System
IBM 1275 Optical Reader/Sorter
Program Planning Guide

This reference publication provides program planning information for the IBM 1275 Optical Reader/Sorter. A prerequisite for this manual is *IBM System/360 Disk Operating System, Supervisor and Input/Output Macros*, GC24-5037.

GC24-5078 IBM System/360 Disk 20
Operating System, Program
Planning Guide for MCAR/CCH
Function, for IBM System/370
Model 145

This publication is a planning aid for the Machine Check Analysis and Recording Channel Check Handler (MCAR/CCH) functions for the IBM System/370 Model 145. The major sections:

1. Describe the functions.

GC24-5079 IBM System/360 DOS 36
Program Planning Guide for MCAR/
CCH Function for IBM System/370
Model 145

Program Number: 360N-CL-453:

This publication is a planning aid for the Machine Check Analysis and Recording and Channel Check Handler (MCAR/CCH) functions for the IBM System/370 Model 145.

The major sections:

1. Describe the functions.
2. Explain how to implement the functions.
3. Provide performance information.

The following manuals are prerequisites to a thorough understanding of this guide:

IBM System/360 Disk Operating System: System Control and System Service Programs, GC24-5036

IBM System/360 Disk Operating System: System Generation and Maintenance, GC24-5033

Titles and abstracts of related publications are listed in the *IBM System/360 Bibliography*, GA22-6822. (12 pages)

GC24-5082 IBM System/360 DOS 20
To OS Management Planning Guide

This publication presents areas for your consideration during the planning stages for the transition from the IBM System/360 Disk Operating System (DOS) to the IBM System/360 Operating System (OS). It is designed to assist management in preparing a total plan for a DOS-to-OS project.

An overview of a transition project is presented followed by discussions on education, organization, operations, standards, system planning, scheduling, and program and file revision considerations. Two appendixes are also included. Appendix A shows a relationship between the transition work flow and OS education. Appendix B is an OS glossary.

This publication emphasizes the considerations for a DOS-to-OS transition project. Because of the differences between data processing installations, the guidelines in this publication will have to be adjusted and tailored to fit the needs of your installation. (36 pages)

GC24-5084 IBM System/360 DOS 20
Program Planning Guide for MCAR/
CCH Function for IBM System/370
Model 155

Program Number: 360N-CL-453

This publication is a planning aid for the Machine Check Analysis and Recording and Channel Check Handler (MCAR/CCH) functions for the IBM System/370 Model 155.

The major sections:

1. Describe the functions.
2. Explain how to implement the functions.
3. Provide performance information.
4. Describe the MODE operator command for the IBM System/370 Model 155.

The following manuals are prerequisites to a thorough understanding of this guide:

IBM System/360 Disk Operating System: System Control and System Service Programs, GC24-5036

IBM System/360 Disk Operating System: System Generation and Maintenance, GC24-5033

Titles and abstracts of related publications are listed in the *IBM System/360 Bibliography, GA22-6822*. (20 pages)

GC24-5085 IBM System/360 DOS 20
IBM 3211 Printer Program Planning Guide

Program Number: 360N-CL-453

This reference publication is a planning guide for programmers, programming managers, and system analysts, who are planning for the IBM 3211 functions of the Disk Operating System.

This information is divided into three major sections:

- The first section is an introduction that explains the IBM 3211 functions of the Disk Operating System.
- The second section explains implementation considerations for the Special Service Control Program associated with the 3211.
- The third section explains Data Management changes for the 3211.

Prerequisites for a thorough understanding and for effective use of this publication are:

IBM System/360 Disk Operating System, System Control and System Service Programs, GC24-5036

IBM System/360 Disk Operating System, Supervisor and Input/Output Macros, GC24-5037

For titles and abstracts of other associated publications, see the *IBM System/360 Bibliography, GA22-6822*. (8 pages)

GC24-9005 IBM System/360 Disk and 29
Tape Operating Systems PL/I Programmer's Guide

This publication complements the Systems Reference Library publication *IBM System/360, PL/I Subset Reference Manual, Form C28-8202*. Its purpose is to aid the programmer and to familiarize him with the techniques of PL/I programming. This publication therefore provides all information that is not part of the PL/I Subset language specifications but required by the programmer to write programs in the PL/I Subset language and to have them compiled and executed in the DOS/TOS environment.

The main topics covered in this publication are:

1. The DOS/TOS environment
2. PL/I data file organization

3. Storage requirements of PL/I programs and program elements

4. The overlay facility
5. Listings produced for PL/I programs
6. Restrictions to the PL/I Subset language

In some instances, the programmer may desire detailed additional information on topics not directly connected with PL/I. A list of all pertinent Systems Reference Library publications is provided in the *Introduction* section of this publication. (112 pages)

GC26-3564 IBM System/360 Model 30 35
Specifications and Operating Guide Tape Overlay Emulator

This publication provides specifications for the IBM System/360 Model 30 Tape Overlay Emulator. A description of the functions of this program and the general requirements for its use are included. This program operates as an extension of the capabilities described in the publication, *IBM System/360 Model 30 1401/1440/1460 Basic Compatibility Feature and Sub-Features*, Order Number GA24-3255. (10 pages)

GC26-3570 IBM System/360 Disk and 28
Tape Operating Systems Report Program Generator Specifications

This publication contains fundamentals of RPG programming and language specifications for the IBM System/360 Disk and Tape Operating Systems, Report Program Generator. This program can be used for System/360 Models 25, 30, 40, 50, 65, and 75. Also included is the job setup information for executing RPG. (220 pages)

GC26-3627 IBM System/360 Basic 36
Operating System Operating Guide—IBM 1070 Process Communication Supervisor

This publication describes operating procedures for the IBM 1070 Process Communication Supervisor. It includes instructions for loading the 1070 routines into the BOS libraries and describes methods of assembling, loading, and executing the PCS and problem programs. A description of error messages and halts is also included. (20 pages)

GC26-3734 IBM S/360 OS Time 21
Sharing Option TSO Assembler Prompter PPDO

This Program Product Design Objectives (PPDO) describes the design objectives and provides the estimated availability data of the subject Program Product. (2 pages)

GC26-3743 IBM System/360 21
Operating System Assembler H Specifications Sheet

This Program Product Specifications (PPS) describes the warranted specifications of the subject Program Product. (2 pages)

GC26-3756 IBM System/360 Operating 21
System Assembler [F] Programmer's Guide

Program Number: 360-AS-037

This publication complements the IBM System/360 Operating System Assembler Language publication. It provides a guide to program assembling, linkage editing, executing, interpreting listings, assembler programming considerations, diagnostic messages, and object output cards. (48 pages)

GC26-3758 IBM System/360 60
Operating System Assembler (H) General Information Manual Program Product 5734-AS1

Assembler H is a new assembler-language processor that extends the basic assembler language and the macro and conditional-assembly language. It is designed to perform high-speed assemblies on IBM System/360 Models 40 and larger that have at least 256K bytes of main storage.

This publication describes the language extensions. It also provides information on system requirements and performance estimates. This manual is designed to aid both planning and programming personnel. The reader is assumed to be familiar with the assembler language and with macro and conditional-assembly language processing. (42 pages)

SC26-3759 IBM System/360 Operating 21
System Assembler H Programmer's Guide

This book tells how to use Assembler H. It describes assembler options, cataloged Job Control Language procedures, assembler listing and output, sample programs, and programming techniques and considerations.

Assembler H is an assembler-language processor for the IBM System/360 Operating System. It performs high-speed assemblies on an IBM System/360 Model 40 or higher with at least 256K bytes of main storage.

This book is intended for all Assembler H programmers. It should be used in conjunction with the Operating System Assembler Language manual, Order Number GC28-6514; the Assembler H Language Specifications, Order Number GC26-3771; and the Assembler H Language Specifications, Order Number GC26-3771; and the Assembler H Messages, Order Number SC26-3770. (86 pages)

GC26-3767 IBM 2740/2968 Audio- 36
Visual Control User's Guide
RPQ Number F30209

This manual tells course authors how to control the audio-visual units with the 2740 remote terminal. It also describes the units and the programming support required to operate them. (32 pages)

SC26-3768 IBM System/360 Oper- 21
ating System Assembler H System
Information

Assembler H was designed to improve many features of Assembler F, and has expanded capabilities as a macro assembler for both system- and user-defined macro languages.

This publication describes installation considerations and system-generation procedures for Assembler H, and is intended primarily for programmers responsible for installing the assembler.

This manual is divided into three independent chapters: "Performance Estimates," "Storage Estimates," and "System Generation." (54 pages)

GC26-3770 IBM System/360 Oper- 21
ating System Assembler H Messages

This book describes the assembly error diagnostic messages and the abnormal assembly termination messages issued by Assembler H. Assembler H is an assembler-language processor for the IBM System/360 Operating System. It performs high-speed assemblies on an IBM System/360 Model 40 or higher with at least 256K bytes of main storage.

This book is intended for all Assembler H programmers. It should be used in conjunction with the *Operating System Assembler Language* manual, Order Number GC28-6514; the *Assembler H Language Specifications*, Order Number GC26-3771; and the *Assembler H Programmer's Guide*, Order Number SC26-3759.

For each error message, this book describes the number and text of the message, the explanation of the error, the assembler's handling of the error, and the programmer's response to correct the error. The introduction to this book describes the format, content, and placement of the error messages. (68 pages)

GC26-3771 IBM System/360 Oper- 21
ating System Assembler H Language
Specifications

This manual provides language specifications for the IBM System/360 Operating System Assembler H. Primarily intended as a reference manual for assembler-language programmers, it is designed to be used in conjunction with *IBM System/360 Operating System Assembler Language*, Order Number GC28-6514.

Sections 1-5 of this manual describe assembler language extensions.

Sections 6-10 of this manual describe extensions to the macro language. (68 pages)

GC26-5999 IBM System/360 28
RPG Translator

This manual provides programming specifications for the IBM System/360 RPG Translator. It describes the operations necessary for converting a 1400 RPG SOURCE program to a System/360 RPG SOURCE program.

The information contained in this publication will enable a 1400 RPG programmer to determine and to formulate preliminary plans for its use.

This manual lists the machine features required and supported, describes the functional characteristics of the program, and provides a section on data checking and operating characteristics. Restrictions to the program are defined, and suggested solutions are provided. A program example is also included.

Related System/360 RPG literature is contained in the following publications: *IBM System/360 Model 20 Report Program Generator*, Order Number GC26-3600; *IBM System/360 Basic Programming Support RPG (Card)*, Order Number GC24-3374; *IBM Basic Operating System/360 RPG Language Specifications (8K Disk)*, Order Number GC24-3387; and *IBM Operating System/360 Report Program Generator Language*, Order Number GC24-3337. (20 pages)

GC27-6908 IBM System/360 35
Conversion Aids: The 7074
Emulator Program for
IBM System/360 Models 50 and 65

Program Number: 360C-EU-725

This publication provides information on the IBM 7074 Emulator Program (360C-EU-725), and is directed to the user who is supplementing or replacing his IBM 7070/7074 Data Processing System with an IBM System/360 Model 50 or 65. Emulation is a technique that utilizes both equipment (Compatibility Feature) and programming to execute object programs written for other data processing systems. (50 pages)

GC27-6909 IBM System/360 30
Operating System—Graphic Program-
ming Services for IBM 2250 Display
Unit

Program Number: 360S-IO-523

This publication describes macro-instructions and routines provided under the IBM System/360 Operating System for use with the IBM 2250 Display Unit.

These programming services are designed to facilitate the assembler-language coding of programs for displaying data in alphameric or graphic form on the 2250 screen and for controlling man-machine communication using the 2250. Included are facilities for creating the image-defining orders and data, for controlling input/output functions of the graphic device, and for handling communications from a 2250 operator. Both basic and express attention handling are described.

Although intended primarily for the programmer coding in System/360 assembler language, portions of this publication are also of interest to installation managers, system engineers, system programmers, and others seeking general information about programming the IBM 2250 Display Unit. (136 pages)

GC27-6911 IBM System/360 35
Conversion Aids: The 7080
Emulator Program for IBM
System/360 Model 65

Program Number: 360C-EU-727

Special machine and programming features expand the capabilities of IBM System/360 Model 65 to include an alternate mode of operation: operation as the IBM 7080 Emulator. The Emulator is the effective equivalent of the IBM 7080 Data Processing System, and is capable of executing programs written for the 7080. This publication describes how to prepare and use a suitably configured System/360 for the execution of 7080 programs.

General information is provided on Emulator characteristics, programming considerations, and operating considerations. Complete instructions for system generation and program use are provided, together with detailed information on error messages and corrective actions. (54 pages)

GC27-6912 IBM System/360 Operating 30
System—Graphic Programming
Services for IBM 2260 Display
Station (Local Attachment)

Program Number: 360S-IO-523

This publication describes programming services for using the IBM 2260 Display Station with the System/360 Operating System. Included are descriptions of macro-instructions for input/output control and for basic and express attention handling, along with some general requirements for using the display station effectively.

Although intended primarily for the programmer coding in System/360 assembler language, portions of this publication are also of interest to installation managers, system engineers, system programmers, and others seeking general information about programming the IBM 2260 Display Station. (48 pages)

GC27-6918 IBM System/360 31
Operating System Maintenance
Program 3605-UT-506

This publication describes the procedure for applying IBM-distributed maintenance material, or user-provided material in a prespecified form, to operating-system libraries. The major portion of this information concerns the Update Analysis Program—a program that determines the applicability of maintenance material for the individual system libraries, and accordingly constructs a job stream that effects the library updating. (37 pages)

GC27-6924 IBM System/360 32
Disk Operating System Vocabulary
File Utility Program for the
IBM 7772 Audio Response Unit

Program Number: 360N-UT-472

This document provides information on the Vocabulary File Utility Program for the IBM 7772 Audio

Response Unit, that enables the user to create, organize, and update the file of word representations from which the audible responses of the IBM 7772 Audio Response Unit are formed. (44 pages)

GC27-6927 IBM System/360 30
Operating System Graphic Programming Services for IBM 2280 and 2282 Film Units

Program Number: 360S-IO-523

This publication contains information for writing programs using the IBM 2280 Film Recorder or the IBM 2282 Film Recorder/Scanner.

For complete coverage of available 2280/82 graphic programming services, this publication must be used with *IBM System/360 Operating System: Graphic Programming Services for IBM 2250 Display Unit*, Order Number GC27-6909.

The information consists primarily of formats and descriptions of macro-instructions that generate orders and data that control the graphic devices. Considerations for user's error handling routines are also included. (56 pages)

GC27-6929 IBM System/360 Conversion 35
Aids: Sample Problems for IBM System/360 Emulator Programs

Program Numbers:

*360C-EU-074
 360C-EU-097
 360C-EU-725
 360C-EU-726
 360C-EU-727
 360C-EU-728
 360C-EU-729
 360C-EU-731
 360C-EU-733*

Sample problems are provided as a part of the distribution material for IBM System/360 Emulator Programs. They are illustrative examples designed to familiarize the user with the techniques required to execute object programs written for other IBM data processing systems under Emulator control. Sample problems are not intended to provide detailed and exhaustive tests or demonstrations of Emulator Programs.

Included in this publication are sample problems for use with the following Emulators: 1401/1440/1460 Model 30, 1401/1460 Model 40, 1410/7010 Models 40 and 50, 1620 Model 30, 7040/7044 Model 65, 7074 Models 50 and 65, 7080 Model 65, and 709/7090/7094/7094II Model 65. (28 pages)

GC27-6932 IBM System/360 25
Operating System Graphic Programming Services for FORTRAN IV

Program Number: 360S-LM-537

This publication describes how a FORTRAN programmer can write graphic programs for use with the IBM 2250 Display Unit in association with the IBM System/360 Operating System. It also describes how the same facilities may be used in a program written in Assembler Language.

The graphic programming services for FORTRAN IV consist of subroutines and functions for displaying characters or graphic forms on the 2250 screen and for controlling communication between the program and the 2250 operator. The subroutines may be called from a program written in the E, G, or H level of FORTRAN IV, or from a program written in Assembler Language. They are not an extension of the FORTRAN IV language, but may be used in conjunction with it.

It is assumed that the FORTRAN user of this publication is experienced in the IBM System/360 Operating System FORTRAN IV language. It is assumed that the Assembler Language user of this publication is experienced in both FORTRAN IV and Assembler Language. (120 pages)

GC27-6933 IBM System/360 Operating 36
System User's Guide for Job Control from the IBM 2250 Display Unit—Preliminary Specifications

This publication describes how a person at an IBM 2250 Display Unit can define and initiate jobs to be processed by the IBM System/360 Operating System. The publication discusses the job control operations that are available at the display unit and provides supplementary information to assist the user. A complete sample job control session is explained with text and illustrations.

The publication is written for a person who is not familiar with the IBM System/360 Operating System. (48 pages)

GC27-6935 IBM System/360 Operating 36
System Planning for Rollout/Rollin

This publication describes the features and capabilities provided by the rollout/rollin feature of the IBM System/360 Operating System. Rollout/rollin is used in conjunction with MVT (multiprogramming with a variable number of tasks) as an aid to main storage management. (16 pages)

GC27-6937 IBM System/360 Operating 25
System and 1130 Disk Monitor System: FORTRAN IV Subroutines for Data Transmission Between a System/360 and an 1130 System Preliminary Specifications

This publication contains preliminary information about subroutines that can be called by a System/360 Operating System FORTRAN IV program or an 1130 System FORTRAN IV program to transmit data from one system to the other. The subroutines enable FORTRAN programmers to perform the same kind of telecommunications as an Assembler Language programmer performs by using the binary synchronous services of the Basic Telecommunications Access Method (in the System/360) and the Synchronous Communications Adapter subroutines (in the 1130). No knowledge of binary synchronous communications is needed to use the subroutines described in this manual. The FORTRAN IV data transmission subroutines can also be used in Assembler Language programs if the proper subroutine linkage is employed.

This publication contains a general description of the data transmission and data conversion subroutines, provides detailed information on the formats of the subroutine calls, and contains coding examples that illustrate use of the subroutines. Detailed information on data conversion from 1130 format to System/360 format and vice versa is provided in Appendix A. (48 pages)

GC27-6938 IBM System/360 36
Operating System and 1130 Disk Monitor System: User's Guide for Job Control from an IBM 2250 Display Unit Attached to an IBM 1130 System Preliminary Specifications

This publication describes how a person at an IBM 2250 Display Unit attached to an IBM 1130 Computing System can define and initiate jobs to be processed by the IBM System/360 Operating System. The job defined at the display unit can either be processed independently in the System/360 or can be processed in conjunction with a related program in the 1130. The publication discusses the job control operations that are available to the 2250 user and provides supplementary information to assist the user at the display unit. A complete sample job is included with text and illustrations.

The information on job control operations is written for a person who is not familiar with the IBM System/360 Operating System, the IBM 1130 Computing System, or the IBM 2250 Display Unit. (64 pages)

GC27-6939 IBM System/360 36
Operating System Planning for Multiprogramming with a Fixed Number of Tasks, Version II (MFT II)

This publication provides information concerning Version II of multiprogramming with a fixed number of tasks (MFT II) for installation personnel who are responsible for selection, evaluation, and implementation of System/360 Operating System configurations. The information is presented in three major categories: concepts, considerations, and characteristics. These sections describe, respectively:

1. The principles of operation of MFT II.
2. How they influence application and operation of the system.
3. Detailed specifications of storage requirements, system generation, and operation of an MFT II system.

The descriptive information is supplemented by examples and illustrations including a sample job scheduling sequence and sample partition configurations for systems with 128K, 256K, and 512K bytes of main storage. (60 pages)

GC27-6940 IBM System/360 Disk 35
Operating System—1401/1440/1460 Emulator Programs; Compatibility Support/30; Compatibility Support/40

*Program Numbers:
 360N-EU-484, CS/30
 360N-EU-485, CS/40*

This publication contains information on the emulation of 1401, 1440, and 1460 object programs

under the control of the Disk Operating System. Compatibility Support/30 and Compatibility Support/40 allow emulation of these programs on the IBM System/360 Models 30 and 40, respectively. Compatibility Support/30 comprises the IBM 1401/1440/1460 Emulator Program, Number 360N-EU-484, and applicable Compatibility Features for the Model 30. Compatibility Support/40 comprises the 1401/1440/1460 Emulator Program, Number 360-EU-485, and the applicable Compatibility Features for the Model 40. In addition, the 1401, 1440, and 1460 object programs can be run on the IBM System/360 Model 25 using the 1401/1440/1460 Emulator Program for Compatibility Support/30 in conjunction with applicable Compatibility Features for the Model 25.

General information concerning machine requirements, program generation, simulation techniques, data formats, control cards, and programming considerations is included, as are detailed explanations of operator service functions, operating procedures, console messages, and special instructions added by the Compatibility Features for the Models 30 and 40.

The 1400 Emulator Programs under DOS allow the user to run 1401/1440/1460 programs with little or no reprogramming, under the Disk Operating System in conjunction with the Compatibility Features. This allows 1400 programs to be run in a stacked job environment, mixed with System/360 jobs. (140 pages)

GC27-6942 IBM System/360 36
Operating System Introduction to Main Storage Hierarchy Support for IBM 2361 Models 1 and 2

This publication contains pre-release information that describes the programming requirements and considerations for the division of main storage into two separately addressable blocks called hierarchies.

Main Storage Hierarchy Support is primarily designed for use with IBM 2361 Core Storage, a stand-alone, economical bulk storage unit. The support provides a technique by which the 2361 can be directly addressed, so that storage can be allocated from it and modules can be loaded into it. Main Storage Hierarchy Support is effective across all versions of the operating system. (24 pages)

GC27-6944 IBM System/360 Operating System 709/7090/7094/7094 II Emulator Program for IBM System/360 Model 85 Preliminary Specifications 35

This publication provides planning information concerning the IBM 7094 Integrated Emulator for the System/360 Model 85. The integrated emulator executes as a problem program under the System/360 Operating System, in conjunction with the 7094 Compatibility Feature (7119). The combination of the program and machine feature enables the Model 85 to execute programs written for the IBM 709, 7090, 7094, and 7094 II Data Processing Systems.

The information in this publication is intended for installation personnel who are responsible for selecting, evaluating and implementing IBM System/360 Operating System configurations. (36 pages)

GC27-6945 IBM System/360 35
Operating System Emulator Program to Emulate the IBM 1401, 1440, and 1460 on the IBM System/370 Model 155

This publication contains planning information about the IBM 1401/1440/1460 Emulator Program for the System/360 Model 155. The emulator program runs as a problem program under control of the MFT or MVT version of the IBM System/360 Operating System on a Model 155 equipped with the IBM Compatibility Feature . . . Using the program and the compatibility feature, the operating system can execute programs written for the IBM 1401, 1440, and 1460 Data Processing Systems.

The information in this publication is intended for installation personnel who are responsible for evaluating, selecting, and implementing IBM System/360 Operating System configurations. (72 pages)

GC27-6946 IBM System/360 35
Operating System Emulator Program to Emulate the IBM 1410 and 7010 on the IBM System/370 Model 155

This publication contains planning information about the IBM 1410/7010 Emulator Program for the System/360 Model 155. The emulator program runs as a problem program under control of the MFT or MVT version of the IBM System/360 Operating System on a Model 155 equipped with the IBM Compatibility Feature . . . Using the program and the compatibility feature, the operating system can execute programs written for the IBM 1410 and 7010 Data Processing Systems.

The information in this publication is intended for installation personnel who are responsible for evaluating, selecting, and implementing IBM System/360 Operating System configurations. (72 pages)

GC27-6948 Emulating the IBM 7074 on the IBM System/370 Model 165 using OS/360 35

This publication contains planning information about the IBM 7074 Emulator Program for the System/370 Model 165. The emulator program runs as a problem program under the MFT or MVT version of the System/360 Operating System. The Model 165 must be equipped with the IBM Compatibility Feature #7117. The emulator program and the compatibility feature enable programs written for the IBM 7074 Data Processing System to be executed on the Model 165.

The information in this publication is for installation personnel responsible for evaluating, selecting, and implementing system configurations. (52 pages)

GC27-6949 IBM System/360 Operating System Operator's Guide for Display Consoles 20

This book tells system operators how to use cathode ray tube (CRT) display devices as operator consoles to run MFT or MVT configurations

of the IBM System/360 Operating System. The display devices supported are:

- Model 85 Operator Console (Feature 5450)
- Model 91 Display Console
- Model 195 Display Console
- 2260 Display Station (local attachment)

After summarizing how to use display devices as operator consoles, the manual describes in detail the operating techniques for each of the three devices. A summary of device characteristics and a glossary are included.

Instructions are given for each device telling:

- How to start the system
- How to enter commands
- How to delete messages
- How to control the screen using the CONTROL command

The book must be used in conjunction with IBM System/360 Operating System: Operator's Reference, Order Number GC28-6691 and IBM System/360 Operating System: Operator's Procedures, Order Number GC28-6692, because a knowledge of the MFT and MVT operating techniques is required. (108 pages)

GC27-6950 IBM System/360 20
Operating System Planning for Display Operator Consoles

This publication contains planning information about Device Independent Display Operator Console Support (DIDOCS) for system analysts and other personnel who are concerned with planning, evaluating, and implementing System/360 Operating System configurations. DIDOCS provides uniform operating characteristics for 2250 Display Units, Models 1 and 3, 2260 Display Stations, Model 1 (local attachment), and Model 85 CRT Displays, and will supersede all existing operator console support for these devices. DIDOCS requires an MFT or MVT system equipped with Multiple Console Support (MCS).

The information is presented in two parts:

- A description of DIDOCS, its capabilities, and the environment in which it functions.
- A discussion of the advantages of using display operator consoles, their effect on system performance, and how they are generated into a system.

There are no prerequisite publications, but the reader is assumed to have an understanding of the system configuration and the requirements for operator consoles at his installation. (32 pages)

GC27-6951 Emulating the IBM 709, 7090, 7094, and 7094 II on the IBM System/370 Model 165 using OS/360 35

This publication contains planning information about the IBM 709/7090/7094/7094 II Emulator Program for the IBM System/370 Model 165. The emulator program runs as a problem program under the MFT or MVT version of the System/360 Operating System. The Model 165 must be equipped with the IBM Compatibility Feature #7119. The emulator program and the compatibility feature enable programs written for the IBM 709, 7090, 7094, and 7094 II Data Processing Systems to be executed on the Model 165.

The information in this publication is for installation personnel responsible for evaluating, selecting, and implementing system configurations. (56 pages)

GC27-6952 Emulating the IBM 370 7080 on the IBM System/370 Model 165 using OS/360 35

This publication contains planning information about the IBM 7080 Emulator Program for System/370 Model 165. The emulator program runs as a problem program under the MFT or MVT version of the System/360 Operating System. The Model 165 must be equipped with the IBM Compatibility Feature #7118. The emulator program and the compatibility feature enable programs written for the IBM 7080 Data Processing System to be executed on the Model 165.

The information in this publication is for installation personnel responsible for evaluating, selecting, and implementing system configurations. (52 pages)

GC28-2000 IBM System/360 Time Sharing System Assembler Language 21

This publication describes the IBM System/360 Time Sharing System Assembler Language, a symbolic programming language used to write programs for IBM System/360. The language provides a convenient means for representing the machine instructions and related data necessary to program the IBM System/360, especially as related to Time Sharing System/360 (TSS/360). The TSS/360 Assembler Program processes the language and provides auxiliary functions for preparing and documenting a program; the Assembler includes facilities for processing the assembler macro language. (132 pages)

GC28-2001 IBM System/360 Time Sharing System Command System User's Guide 36

The command system in Time Sharing System/360 gives to the user the facilities he needs for constructing, executing, and debugging his programs; also, he can create, modify, share, and copy data sets; he can move them to or from input/output devices. The user can modify and add to the IBM-supplied command system to meet his specific requirements. (232 pages)

GC28-2003 IBM System/360 Time Sharing System Concepts and Facilities 20

This publication explains basic concepts of IBM System/360 Time Sharing System, or Time Sharing System/360 (TSS/360), and describes the available facilities.

Time Sharing System/360 is a comprehensive programming system used in conjunction with IBM System/360 computers that have time-sharing features. TSS/360 comprises a supervisory program, a group of service programs, and a group of user programs. The supervisory program controls operation of the system and provides the time-sharing environment. The service programs perform task- and data-management functions in response to user or system requests. The user programs perform language processing, linkage editing, and other work defined by the user's problem programs.

The primary purpose of TSS/360 is to provide many users with simultaneous conversational (on-line) access to a computing system that may have a single processor, or multiple processors. The combination of machine and program features gives each user the impression that he has sole possession of the system. He uses the system as if it had a directly accessible main-storage addressing space equal to the addressing capability of the system, rather than its actual main-storage capacity.

While the system is operating conversationally, for many simultaneous users, it can also operate non-conversationally, with batch-type processing jobs, in the background. (132 pages)

GC28-2004 IBM System/360 Time Sharing System Assembler User Macro Instructions 36

IBM System/360 Time Sharing System provides comprehensive program and data management services which, together with communication, bulk output, and interruption handling services, are requested through macro instructions. These macro instructions are written in the assembler language as an aid to programming and processing time-shared tasks. (228 pages)

GC28-2005 IBM System/360 Time Sharing System Linkage Editor 31

This publication describes and illustrates the linkage editor, an optional service program available for the IBM System/360 Time Sharing System (TSS/360). The linkage editor connects and edits program modules that have been assembled or compiled separately to produce a single program module that can be efficiently loaded by the dynamic loader at execution time. Linkage editor facilities are illustrated in conversational and nonconversational modes of operation. (56 pages)

GC28-2006 IBM System/360 Time Sharing System—Time Sharing Support System 48

This publication describes the Time Sharing Support System and the command language used to operate it. This system is used only by system programmers with authority code O or P and it is not intended to be available to any other Time Sharing System/360 users; consequently, this manual contains no information required by users other than properly authorized system programmers.

The Time Sharing Support System is an on-line program error analysis facility that provides the capability of collecting data from the Time Sharing System/360 for analysis and of altering the Time Sharing System/360 storage and machine registers. These functions may be performed on command from a terminal or dynamically during TSS/360 execution; and the programs, tables, and control blocks of real, virtual, and secondary storage can be referenced. (64 pages)

GC28-2007 IBM System/360 Time Sharing System IBM FORTRAN IV 25

This publication describes and illustrates the use of the IBM FORTRAN IV language for the IBM System/360 Time Sharing System (TSS/360).

The IBM FORTRAN IV language is a symbolic programming language that parallels the symbolism and format of mathematical notation. It provides many programming features and facilities that can be used to express as a meaningful FORTRAN program the method of solution of a mathematical problem. (120 pages)

GC28-2008 IBM System/360 Time Sharing System—System Programmer's Guide 50

IBM System/360 Time Sharing System (TSS/360) makes a distinction between user and system programmers. This publication is specifically intended for persons responsible for maintaining, modifying, or extending the system and discusses:

- Operating environment
- Program structure
- Coding practices and conventions
- Privileged supervisor call instructions
- Serviceability aids
- System macro definitions
- Changing TSS/360
- Privilege Class E

(188 pages)

GC28-2010 IBM System/360 Time Sharing System—System Generation and Maintenance 31

This publication explains how an installation generates and maintains IBM System/360 Time Sharing System (TSS/360).

System generation is the process of specifying and creating an installation adapted TSS/360. An operable time-sharing system is necessary for system generation. Initially, a basic system is provided.

System maintenance is the procedure for incorporating changes to TSS/360.

This publication presents:

1. The construction of the basic TSS/360.
2. The method of specifying, through SYSGEN macro instructions, such installation-dependent information as machine configuration, task-management requirements, and command-language default specifications.
3. The application of this information to create a new TSS/360.

4. The maintenance process for TSS/360.
 5. The method of dynamically modifying TSS/360 for the duration of a startup-to-shutdown session. (96 pages)

GC28-2017 IBM System/360 Time Sharing System Terminal User's Guide 36

This manual gives instructions for operating the IBM 2741 Communications Terminal and the IBM 1050 Data Communications System in the IBM System/360 Time Sharing System. (32 pages)

GC28-2023 IBM System/360 Time Sharing System Master Index 20

This index has been compiled from the indexes of the existing SRL publications that describe the IBM System/360 Time Sharing System. It is a subject index that refers the reader to the individual publications. Actual page references will be found in the individual indexes. (92 pages)

GC28-2024 IBM System/360 Time Sharing System Manager's and Administrator's Guide 36

This manual provides detailed information on the command system as used by system managers and system administrators in Time Sharing System/360. They share an identical set of commands with which they control access to the time-sharing system. (36 pages)

GC28-2025 IBM System/360 Time Sharing System FORTRAN Programmer's Guide 25

This publication describes how to use the IBM System/360 Time Sharing System (TSS/360) for compiling and executing programs written in the FORTRAN IV language. It also describes how to use the services and features of TSS/360 that, while not directly related to FORTRAN programming, are frequently of use to the FORTRAN programmer. (176 pages)

GC28-2026 IBM System/360 Time Sharing System FORTRAN IV—Library Subprograms 25

This publication describes the FORTRAN IV-supplied subprograms provided with IBM System/360 Time Sharing System (TSS/360) and provides the information necessary to use the subprograms in either a FORTRAN IV or an assembler-language program. (72 pages)

GC28-2028 IBM System/360 Time Sharing System Test and Maintenance User's Guide 37

This publication describes, for the IBM System/360 Time Sharing System (TSS/360), how to use the On Line Test System (OLTS), and how to retrieve system error recordings using the Error Recording Edit and Print (EREPs7/UMEREP) procedure. Device partitioning and system quiescence are described, and the error recordings interpreted.

This publication is meant for use by system monitor and/or maintenance personnel. It may be used to determine the hardware component responsible for failures, and in the testing of the component. (68 pages)

GC28-2032 IBM System/360 Time Sharing System Assembler Programmer's Guide 21

This publication explains the use of Time Sharing System/360 (TSS/360) for assembler language applications programmers. It describes how to assemble, store, and execute programs in TSS/360, as well as how to identify data sets, process them as input/output in problem programs, and manipulate them in various ways (such as erasing, copying, modifying, and cataloging them).

Task Management and Data Set Management are described so that you may efficiently utilize the time sharing facilities. Both system-supplied and user-defined commands are shown, including the flexibility of the Text Editor, the BUILTIN command, PROCDEF, and the User Profile. (160 pages)

GC28-2033 IBM System/360 Time Sharing System Operator's Guide 36

This manual provides detailed information on the functions of the system operator for the time sharing system, and on the facilities of the command language reserved for the operators. The system operator has a set of commands with which he controls and monitors the system configuration and handles system requests. (44 pages)

GC28-2034 IBM Systems/360 Time Sharing System Multiterminal Task Programming and Operation 50

This publication describes how to create a multi-terminal (MTT) task, which will run under the IBM System/360 Time Sharing System (TSS/360). It also explains how to write an MTT application program, and how to connect it to a multiterminal task.

The publication is meant for use by TSS/360 installations as a reference book for persons responsible for administering and/or writing an MTT application program. (52 pages)

GC28-2037 IBM System/360 Time Sharing System—System Messages 20

The IBM System/360 Time Sharing System provides for a dialogue between the user and the system. The system participates in this dialogue with a series of messages, which provides the recipient with the information he requires to fulfill his task. These messages may be received at a remote terminal in the conversational mode, in the data set created as part of the output of a nonconversational task, or at the operator's terminal in the machine room.

The publication lists and explains all of the messages issued by all IBM-supplied components of the IBM System/360 Time Sharing System. Furthermore, it contains additional information with each message, such as the identification code of the modules issuing and determining the need for the message, the transmittal technique, and where appropriate the format of the associated dump or the completion date. (496 pages)

GC28-2038 IBM System/360 Time Sharing System Independent Utilities 32

This publication discusses the use of the independent utility programs that support IBM System/360 Time Sharing System (TSS/360), their features, functions, capabilities, control statements, and record formats. The TSS/360 independent utility programs are: direct-access storage device initialization (DASDI), direct-access storage device dump/restore (DASDDR), direct-access print (DADUMP), and core dump. (32 pages)

GC28-2043 IBM System/360 Time Sharing System Addendum 20

This addendum presents the specifications for program changes that have been made recently to the IBM System/360 Time Sharing System (TSS/360).

The features described herein are different from those covered in the previous *Addendum*, Order Number GC28-2043-4, which has been obsoleted by a recent update of the TSS/360 publications series.

This addendum should be regarded as a required supplement to the present TSS/360 publications. (20 pages)

GC28-2044 IBM System/360 Time Sharing System Planning for Remote Job Entry 36

This is a planning aid to be used prior to the availability of the remote job entry feature of IBM System/360 Time Sharing System.

Remote job entry provides all central TSS/360 batch processing facilities to remote locations. The input/output device used at remote stations is an IBM 2780 Data Transmission Terminal Model 1. (16 pages)

GC28-2045 IBM System/360 Time Sharing System PL/I Reference Manual 29

This publication provides the rules for writing PL/I programs that are to be compiled using the PL/I Compiler under the IBM System/360 Time Sharing System. (332 pages)

GC28-2046 IBM System/360 Time Sharing System PL/I Library Computational Subroutines 29

This publication gives details of the computational subroutines available in the PL/I Library. These subroutines are used by the PL/I compiler in the implementation of PL/I built-in functions and of the operators used in the evaluation of PL/I expressions. Not all PL/I built-in functions and expression operators are supported by the PL/I Library; the compiler generates in-line code for a small number of them. The details provided include summaries of the mathematical methods used, and (where appropriate) figures for range and accuracy. (56 pages)

GC28-2048 IBM System/360 Time Sharing System Introducing TSS/360 20

A subset of Time Sharing System/360 (TSS/360) is presented in this book to allow use of basic system facilities without an extensive knowledge of the command system, by which system functions are invoked. The reader is presumed to have at least a basic knowledge of FORTRAN. In addition, the user profile under which the reader will use TSS/360 should be altered as explained in Appendix B. This can be done by the reader himself, if necessary; preferably, however, it should be done by someone in a supervisory or tutorial relationship to the reader.

The altered user profile can be changed again by the reader if he progresses to using the full command system. The full system is explained in other books of the TSS/360 Systems Reference Library, such as *Command System User's Guide*, Order Number GC28-2001, and *FORTRAN Programmer's Guide*, Order Number GC28-2025.

This book contains basic information on the three kinds of terminals that can be used with TSS/360. If more information is needed, see *Terminal User's Guide*, Order Number GC28-2017. (56 pages)

GC28-2056 IBM System/360 Time Sharing System Data Management Facilities 30

The data management facilities of TSS/360, described in this manual, provide the users with standardized methods for handling collections of data, while taking maximum advantage of the time-shared environment in which they operate. (96 pages)

GC28-6380 IBM System/360 Operating System COBOL (F) Programmer's Guide 24

Program Numbers:
360S-CB-524
360S-LM-525

This publication describes how to compile, linkage edit, and execute a COBOL (F) program. The text also describes the output from each of these steps. In addition, it explains options of the compiler and many available features of the operating system. (150 pages)

GC28-6394 IBM System/360 Disk Operating System USA Standard COBOL 24

COBOL (Common Business Oriented Language) is a programming language, similar to English, that is used for commercial data processing. It was developed by the Conference On Data Systems Languages (CODASYL). The U. S. A. standard of the language is USA Standard COBOL, X3.23-1968, as specified by the United States of America Standards Institute.

IBM System/360 Disk Operating System USASI COBOL incorporates the eight processing modules defined in the USA standard. These modules include: Nucleus, Table Handling, Sequential Access, Random Access, Sort, Report Writer, Segmentation, and Library. A significant number of IBM extensions as well. The IBM implementation of USA Standard COBOL also complies with the first Draft ISO Recommendation on COBOL.

This publication gives the programmer the rules for writing programs that are to be compiled by the IBM USASI COBOL compiler under the Disk Operating System. It is meant to be used as a reference manual in the writing of IBM USASI COBOL programs. (360 pages)

GC28-6395 IBM System/360 COBOL Differences USA Standard COBOL Conversion 24

This publication summarizes the differences between the current IBM System/360 COBOL languages—COBOL D, COBOL E, and COBOL F—and the IBM COBOL languages conforming to the full USA Standard COBOL—IBM System/360 Operating System USASI COBOL and IBM System/360 Disk Operating System USASI COBOL. It also summarizes new features offered in the IBM USASI COBOL languages.

This Differences Manual is meant to be a supplementary reference manual. Therefore, it is advisable that it be used only in conjunction with the IBM USASI COBOL Language Manuals. (52 pages)

GC28-6396 IBM System/360 Operating System USA Standard COBOL 24

COBOL (Common Business Oriented Language) is a programming language, similar to English, that is used for commercial data processing. It was developed by the Conference on Data System Languages

(CODASYL). The U. S. A. standard of the language is USA Standard COBOL X3.23-1968, as specified by the United States of America Standards Institute.

IBM System/360 Operating System USASI COBOL incorporates the eight processing modules defined in the USA standard. These modules include: Nucleus, Table Handling, Sequential Access, Random Access, Sort, Report Writer, Segmentation, and Library. A significant number of IBM extensions are implemented as well. The IBM implementation of USA Standard COBOL also complies with the first Draft ISO Recommendation on COBOL.

This publication gives the programmer the rules for writing programs that are to be compiled by the IBM USASI COBOL compiler under the Operating System. It is meant to be used as a reference manual in the writing of IBM USASI COBOL programs. (364 pages)

GC28-6397 IBM System/360 Disk Operating System FORTRAN IV Programmer's Guide 25

Program Numbers:
360N-FO-479
360N-LM-480

This publication describes the procedures for compiling and executing FORTRAN programs under control of the Disk Operating System. Its purpose is to guide the programmer with examples and techniques of the FORTRAN language. It also exposes the user to the components of the control program and facilities of the IBM System/360 Disk Operating System. (100 pages)

GC28-6401 DOS/360 American National Standard Subset COBOL Compiler, PPDO 21

This Program Product Design Objectives (PPDO) describes the design objectives and provides the estimated availability date of the subject Program Product.

GC28-6403 Program Number 5736-CB1 60

COBOL (Common Business Oriented Language) is a programming language, similar to English, that is used for commercial data processing. It was developed by the Conference On Data Systems Languages (CODASYL). The U. S. A. standard of the language is American National Standard COBOL, X3.23-1968, (formerly known as USA Standard COBOL), as approved by the American National Standards Institute (ANSI).

IBM System/360 Disk Operating System American National Standard Subset COBOL incorporates six processing modules of the full American National Standard. These modules are:

Nucleus	2NUC 1,2
Sequential Access	2SEQ 1,2
Random Access	2RAC 0,2
Table Handling	2TBL 1,3
Library	1LIB 0,2
Segmentation	1SEG 0,2

A significant number of IBM extensions to these modules are implemented as well; these extensions are printed on a shaded background.

This publication gives the programmer the rules for writing programs that are to be compiled by the IBM American National Standard Subset COBOL compiler under the Disk Operating System. It is meant to be used as a reference manual in the writing of IBM American National Standard COBOL programs. (296 pages)

GC28-6406 OS S/360 American National Standard Full COBOL Compiler Version 3, PPDO 29

This Program Product Design Objectives (PPDO) describes the design objectives and provides the estimated availability date of the subject Program Product.

GC28-6407 IBM System/360 Operating System American National Standard Full COBOL Compiler and Library Version 3 General Information 24

Program Number: 5734-CB1

This publication gives general information about the IBM System/360 Operating System American National Standard Full COBOL Compiler and Library, Version 3, an implementation compatible with the highest level of American National Standard COBOL. The Version 3 Compiler and Library is a Program Product that operates under control of the IBM System/360 Operating System. Included here are brief descriptions of the compiler's features, as well as information on operating system requirements and machine configuration.

This publication is intended as an aid in evaluation and planning; it is not meant for the COBOL programmer. Publications for the COBOL programmer will be provided when the IBM System/360 Operating System American National Standard Full COBOL Compiler and Library, Version 3, becomes available. (14 pages)

GC28-6420 S/360-DOS: American National Standard Full COBOL Compiler Version 3, PPDO 29

This Program Product Design Objectives (PPDO) describes the design objectives and provides the estimated availability date of the subject Program Product.

GC28-6421 IBM System/360 Disk Operating System American National Standard Full COBOL Compiler Version 3 and Associated COBOL Object-Time Subroutine Library General Information 24

*Program Numbers: 5736-CB2
5736-LM2*

This publication gives general information about the IBM System/360 Disk Operating System American National Standard Full COBOL

Compiler Version 3, an implementation compatible with the highest level of American National Standard COBOL, and its associated COBOL object-time Subroutine Library. The Version 3 Compiler and the Subroutine Library are Program Products that operate under control of the IBM System/360 Disk Operating System. Included here are brief descriptions of the compiler's features and a description of the Subroutine Library, as well as information on operating system requirements and machine configuration.

This publication is intended as an aid in evaluation and planning; it is not meant for the COBOL programmer. Publications for the COBOL programmer will be provided when the IBM System/360 Disk Operating System American National Standard Full COBOL Compiler Version 3 and the Subroutine Library become available. (14 pages)

GC28-6428 S/360 DOS: American National Standard Full COBOL Library, PPDO

This Program Product Design Objectives (PPDO) describes the design objectives and provides the estimated availability date of the subject Program Product.

GC28-6429 IBM System/360 Operating System Linkage Editor (E) Installation Reference Material 31

Program Number: 360S-ED-510

The Linkage Editor (E) is released as an independent component intended for installation under the IBM System/360 Operating System. The minimum engineering change level required for implementation of the component is the same as that required for Release 18 of the Operating System. No functional or performance enhancements over the Release 18 version of the Linkage Editor (E) have been incorporated into this component and none are planned for the future.

This publication defines the procedure necessary to install the Linkage Editor (E) in an existing operating system. It is intended for use by system programmers or planners who supervise the generation and maintenance of an installation's operating system. Information on using the Linkage Editor (E) can be found in IBM System/360 Operating System: Linkage Editor and Loader, Order Number GC28-6538-8. The internal logic of the Linkage Editor (E) is described in IBM System/360 Operating System: Linkage Editor (E) Program Logic Manual, Order Number GY28-6610. (12 pages)

GC28-6430 IBM System/360 Operating System Basic FORTRAN IV (E) Compiler Installation Reference Material 25

Program Number: 360S-FO-092

The Basic FORTRAN IV (E) compiler is released as an independent component that requires installation under the IBM System/360 Operating System. The minimum engineering change level

required for implementation of the component is the same as that required for Release 18 of the operating system. No functional or performance enhancements over the Release 18 version of the Basic Fortran IV (E) compiler have been incorporated into this component and none are planned for the future.

This publication describes the procedure for installing the Basic FORTRAN IV (E) compiler in an existing operating system. It is intended for use by system programmers or planners who supervise the generation and maintenance of an installation's operating system. Information on using the compiler can be found in IBM System/360 Operating System: Basic FORTRAN IV (E) Programmer's Guide, Order Number GC28-6603. The internal logic of the compiler is described in IBM System/360 Operating System: FORTRAN IV (E) Program Logic Manual, Order Number GY28-6601. (16 pages)

GC28-6501 IBM 7090/7094 Support Package for IBM System/360 35

The IBM 7090/7094 Support Package for the IBM System/360 consists of three programs. These programs are designed to permit the assembly, testing, and execution on an IBM 709, 7090, 7094, or 7094 II Data Processing System, of programs written for an IBM System/360. The three component programs are a 7090 assembly program, a 7090 simulator program, and a 1401 input program.

The support package can process all System/360 assembler language and machine language programs that are not specifically dependent on input/output timing considerations. It accepts the machine instruction and assembler instruction mnemonic codes of the IBM System/360 special support basic assembler language and simulates the standard, scientific, commercial, universal, storage protection, and direct control instruction sets of System/360. It simulates most input/output operations and most interruption procedures of System/360. Simulation of up to 64K bytes of System/360 main storage is allowed. With certain limitations, the support package simulates the operations of the 1052 Printer-Keyboard, 1402 Card Read Punch, 1403 Printer, 1442 Card Read Punch, 1443 Printer, and the 2401, 2402, 2403, and 2404 Magnetic Tape Units. In addition, it provides extensive facilities for use in detecting and tracing errors in object programs.

Assembly and simulator programs operate under a supervisor program called in by the 7090/7094 Operating System Monitor, IBSYS.

It is assumed that the user of this publication is familiar with the basic assembler language and with the *IBM System/360 Principles of Operation*, Order Number GA22-6821. (73 pages)

GC28-6503 IBM System/360 Basic Programming Support—Basic Assembler (Card) Specifications 20

Program Number: 360P-AS-021

This publication contains information required for writing programs in the Basic Assembler language, a symbolic programming language for the IBM System/360. The Basic Assembler language permits the use of symbolic operation codes and addresses instead of machine-language codes and addresses, and

provides other conveniences for the programmer in using the full capabilities of the IBM System/360. Basic Assembler language source programs are translated into object programs by the Basic Assembler.

This publication provides a description of the Basic Assembler language, a list of symbolic instructions with their machine-language equivalents, and explanations of the instructions available to the programmer for controlling the Basic Assembler. A description of the Basic Assembler is included, emphasizing those features concerned with the planning and writing of source programs. (65 pages)

GC28-6514 IBM System/360 Operating System Assembler Language 21

This publication contains specifications for the IBM System/360 Operating System Assembler language (Levels E and F).

The assembler language is a symbolic programming language used to write programs for the IBM System/360. The language provides a convenient means for representing the machine instructions and related data necessary to program the IBM System/360. The IBM System/360 Operating System Assembler Program processes the language and provides auxiliary functions useful in the preparation and documentation of a program, and includes facilities for processing the assembler macro language.

Part I of this publication describes the assembler language.

Part II of this publication describes an extension of the assembler language—the macro language—used to define macro-instructions. (148 pages)

GC28-6515 IBM System/360 FORTRAN IV Language 25

This publication describes and illustrates the use of the FORTRAN IV language for the IBM System/360 Operating System, the IBM System/360 Model 44 Programming System, and the IBM System/360 Disk Operating System. (128 pages)

GC28-6516 IBM System/360 Operating System COBOL Language 24

Program Numbers:
(COBOL E) 360S-CO-503
(COBOL F) 360S-CB-524

COBOL (Common Business Oriented Language) is a programming language, similar to English, that is used for commercial data processing. It was developed by the Conference of Data Systems Languages (CODASYL).

This publication provides the programmer with rules for writing programs that are to be compiled by the COBOL E and COBOL F compilers under System/360 Operating System. Any violation of the rules for System/360 Operating System COBOL as defined in this publication is considered an error. The features implemented by the COBOL F compiler and not by COBOL E, and the IBM extensions to COBOL, are listed in an appendix.

Programmers unacquainted with COBOL should read the programmed instruction textbook *COBOL Program Fundamentals*, Order Number SR29-0205, with its reference handbook, Order Number SR29-0206. (152 pages)

GC28-6529 IBM System/360 Simulator for the IBM 1620 Model 1 and 2 Preliminary Specifications 35

This publication contains information needed in planning for use of the Simulator during the conversion of a 1620 installation to a System/360 installation.

In effect, the Simulator will enable the System/360 to perform as a 1620. This will permit the running of 1620 programs that are not rewritten for the System/360.

The reader should be familiar with the contents of the following publications: *IBM System/360 System Summary*, Order Number GA22-6810; *IBM 1620 Central Processing Unit Model 1*, Order Number GA26-5706 or *IBM 1620 Central Processing Unit Model 2*, Order Number GA26-5781. (16 pages)

GC28-6530 IBM System/360 Conversion Aids: The 7070/7074 Simulator for IBM System/360 35

Program Number: 360C-SI-753

This document provides information on the IBM System/360 Simulator for the IBM 7070/7074, and is directed to the user who is replacing his IBM 7070/7074 Data Processing System with an IBM System/360 Model 40, 50, 65, or 75. Simulation is a technique which uses System/360 instruction sequences to perform the functions of 7070/7074 instructions, thus permitting the user to execute object programs written for the 7070/7074. (68 pages)

GC28-6531 IBM System/360 Conversion Aids: The 7080 Simulator for IBM System/360 35

Program Number: 360C-SI-751

This document provides information on the IBM System/360 Simulator for the IBM 7080, and is directed to the user who is replacing his IBM 7080 Data Processing System with any model IBM System/360 with at least 131,072 bytes of main storage. Simulation is a technique that uses System/360 instruction sequences to perform the functions of 7080 instructions, thus permitting the user to execute object programs written for the 7080. (64 pages)

GC28-6532 IBM System/360 Conversion Aids: The 7090/7094 Simulator for IBM System/360 35

Program Number: 360C-SI-750

This document provides information on the IBM System/360 Simulator for the IBM 7090/7094 I/7094 II and is directed to the user who is

replacing his IBM 7090/7094 I/7094 II Data Processing System with an IBM System/360 Model 40, 50, 65, or 75. Simulation is a technique which uses System/360 instruction sequences to perform the functions of 7090/7094 I/7094 II instructions, thus permitting the user to execute object programs written for the 7090/7094 I/7094 II. (64 pages)

GC28-6534 IBM System/360 Operating System Introduction 20

This publication describes the general organization, function, and application of IBM System/360 Operating System.

The operating system is designed to extend the performance and application of Computing System/360 and to assist the manager, programmer, and operator of the system. The operating system consists of a comprehensive set of language translators and service programs operating under the supervisory control and coordination of an integrated set of control routines. It is designed for use with Models 30, 40, 50, 65, and 75 of Computing System/360. The operating system is located in direct-access storage, such as disk or drum, and operates on computing systems that have 32,768 bytes or more of main storage. (24 pages)

GC28-6535 IBM System/360 Operating System Concepts and Facilities 20

This publication describes the basic concepts of the IBM System/360 Operating System (the operating system) and guides the programmer in the use of its facilities.

The operating system is a comprehensive set of language translators and service programs operating under the supervision and coordination of an integrated control program. It assists the programmer by extending the performance and application of the computing system. (64 pages)

GC28-6538 IBM System/360 Operating System Linkage Editor 31

This publication provides programmers and systems analysts with the information necessary to make effective use of the linkage editor of IBM System/360 Operating System. Included are descriptions of the functions performed automatically by the linkage editor as well as those performed in response to control statements prepared by the programmer.

The linkage editor combines and edits modules to produce a single module that can be loaded by the control program. The linkage editor operates as a processing program rather than as a part of the control program. (84 pages)

GC28-6539 IBM System/360 Operating System Job Control Language 36

This publication describes the facilities of the Job Control Language, and illustrates how to use these facilities in various applications. Information coded

by programmers on job control statements is used by the System/360 Operating System to initiate and control the processing of jobs.

Information in this publication is applicable to systems with PCP, MFT, and MVT. (90 pages)

GC28-6543 IBM System/360 Operating 33
System Sort/Merge

Program Number: 360S-SM-023

This publication contains specifications for the IBM System/360 Operating System Sort/Merge program, including control statement preparation, program operation, I/O device assignment, and timing estimates. The program has generalized sorting and merging capabilities that can be tailored to the needs of particular installations and applications. (80 pages)

GC28-6550 IBM System/360 Operating 20
System
System Programmer's Guide

This publication consists of self-contained chapters, each of which provides information on how to modify, extend, or implement capabilities of the IBM System/360 Operating System control program. It is designed primarily for system programmers responsible for maintaining, updating, and extending the operating system features.

Topics:

- Catalog and VTOC Maintenance
- Adding SVC Routines
- Adding Accounting Routines
- IECDSECT, IEFJFCBN, and IEFUCBOB
- Macro-Instructions
- The Must Complete Function of ENQ/DEQ
- The EXCP Macro-Instruction
- The XDAP Macro-Instruction
- The Tracing Routine
- Implementing Data Set Protection
- PRESRES Volume Characteristic List
- Residency Options and Link Pack Area
- MVT Job Queue Formatting
- System Macro-Instructions
- Adding System Output Writer Routines
- Output Separators
- System Reader, Initiator, and Writer Cataloged Procedures
- Writing Rollout/Rollin Installation Appendages
- Adding a Universal Character Set Image to the System Library
- The Shared Direct Access Device Option
- The Time Slicing Facility
- Graphic Job Processor Procedures
- Satellite Graphic Job Processor Procedures. (244 pages)

GC28-6551 IBM System/360 Operating 20
System Storage Estimates

This publication contains instructions, formulas, and tables to be used in estimating the main and auxiliary storage requirements of any configuration of the IBM System/360 Operating System. This publication is intended for three types of users: sales personnel, who will use the introduction to

evaluate the feasibility of using the configurations; systems programmers, who will use the publication to plan the storage requirements of a new system and to determine the amount of storage available to the problem programmer; the problem programmer, who will use the dynamic storage section to estimate the requirements of his jobs. (128 pages)

GC28-6554 IBM System/360 Operating 31
System
System Generation

System generation is a process that generates an IBM System/360 Operating System adapted to both the machine configuration and the data processing requirements of an installation. The system generation process is performed under the control of an existing IBM System/360 Operating System. This publication provides information on the machine and operating system requirements for system generation, the initialization of system volumes and data sets, the macro-instructions used in specifying system generation, the methods of including user-written programs in the operating system, restart procedures, and the sample programs used to test the new system.

IBM provides a starter operating system that can be used for the first system generation. The procedures required to initialize the starter system are also described in this publication. (216 pages)

GC28-6559 IBM System/360 Transition 24
Aids: COBOL Language Conversion
Program (1401-CB-701) for the
IBM 1401

This publication contains preliminary information about the IBM COBOL Language Conversion Program (COBOL LCP). The COBOL LCP facilitates transition to IBM System/360 by converting COBOL source programs written for IBM current-system COBOL compilers into source programs for a System/360 COBOL compiler, Design Level E or Design Level F. This publication is intended to assist users of current COBOL in planning for use of the COBOL Language Conversion Program. (42 pages)

GC28-6560 IBM System/360 Conversion 25
Aids: FORTRAN II Language
Conversion Program for the IBM 1401

Program Number: 1401-FO-702

This publication contains information about the IBM FORTRAN II Language Conversion Program (FORTRAN LCP). The FORTRAN LCP facilitates transition to IBM System/360 by detecting statements in FORTRAN II source programs that are incompatible with System/360 FORTRAN IV, by converting these statements to the proper System/360 format when possible, and by providing message codes for statements that cannot be converted. This publication is intended to assist users of current FORTRAN in the use of the FORTRAN Language Conversion Program. (71 pages)

GC28-6561 IBM System/360 Conversion 35
Aids: The 1401/1460 Emulator
Program for IBM System/360
Model 40

Program Number: 360C-EU-074

This publication contains the information required to use the IBM 1401/1460 Emulator for IBM System/360 Model 40. The Emulator comprises the IBM 1401/1460 Emulator Program (360C-EU-074) and IBM 1401/1460 Compatibility Feature #4457. General information concerning machine requirements, data formats, and control cards is included, as are detailed explanations of operating procedures, user modification of the Emulator Program, and special instructions added by the Compatibility Feature.

The Emulator allows programs written for IBM 1401/1460 card/tape/disk systems to be executed on System/360 Model 40, with little or no reprogramming. Emulation provides substantial improvement over the speeds possible with simulation. (44 pages)

GC28-6563 IBM System/360 Conversion 35
Aids: The 1410/7010 Emulator
Program for IBM System/360
Model 40

Program Number: 360C-EU-728

This publication provides information for the user who is planning to supplement or replace his IBM 1410 or 7010 card/tape/disk system with an IBM System/360 Model 40. Emulation is a technique which utilizes both equipment capabilities (Compatibility Feature #4478) and programming (Emulator Program 360C-EU-728) to execute object programs of other data processing systems. The 1410/7010 Emulator allows the user to run 1410/7010 programs on the System/360 Model 40 with little or no reprogramming. This technique provides substantial improvement over the speeds achievable with simulators.

Included in this document are the characteristics, functions, requirements, limitations, and operating procedures of the Emulator. (50 pages)

GC28-6565 IBM System/360 Conversion 35
Aids: The 709/7090/7094/7094 II
Emulator Program for IBM System/360
Model 65

Program Number: 360C-EU-729

This publication describes the characteristics and use of the IBM 7090 Emulator Program, a component of the IBM 7090 Emulator. The Emulator consists of this program, and special machine additions and modifications called the IBM 7090 Compatibility Feature (#7119). The combination of program and machine feature enables the user to execute, on his System/360 Model 65, programs written for the IBM 709, 7090, 7094, and 7094 II Data Processing Systems. (68 pages)

GC28-6568 IBM System/360 Conversion Aids: The 1410/7010 Emulator Program for IBM System/360 Model 50 35

Program Number: 360C-EU-726

This publication provides information for the user who is planning to supplement or replace his IBM 1410 or 7010 card/tape/disk system with an IBM System/360 Model 50. Emulation is a technique that utilizes both machine adaptations and programming to execute object programs written for other data processing systems. The 1410/7010 Emulator (Compatibility Feature #4478 and Emulator Program No. 360C-EU-726) allows the user to run 1410/7010 programs on the System/360 Model 50, with little or no reprogramming. This technique provides substantial improvement over the speeds that can be achieved with simulators.

Included in this document are the characteristics, functions, requirements, limitations, and operating procedures of the Emulator. (42 pages)

GC28-6570 IBM System/360 Transition Aids COBOL Language Differences 24

This publication summarizes the System/360 and Current Systems specifications for major IBM COBOL language elements requiring evaluation, and possible conversion, during the transition to IBM System/360 COBOL. System/360 COBOL differences from Current Systems COBOL are also summarized. Where pertinent, the distinction is made between Level E and Level F COBOL for System/360. (79 pages)

GC28-6583 IBM System/360 Basic Programming Support—FORTRAN IV. (Tape) 25

Program Number: 360P-FO-031

This publication describes the procedures for compiling and executing programs written in the Basic Programming Support FORTRAN IV language. It also includes the procedures for editing and updating the Basic Programming Support FORTRAN IV system and for preparing a Basic Programming Support FORTRAN IV job for a machine run. (86 pages)

GC28-6585 IBM System/360 Model 65 Emulation of the IBM 7040/7044 Data Processing Systems 35

This publication provides preliminary information about the characteristics, functions, requirements, limitations, and operating procedures of the IBM 7040/7044 Emulator. This Emulator allows the user who plans to supplement or replace his present data processing system with the IBM System/360 Model 65 to execute his current programs on the IBM System/360 without reprogramming. (28 pages)

GC28-6586 IBM System/360 Operating System Utilities 32

*Program Numbers:
360S-UT-506
360S-UT-507*

This publication discusses the capabilities of the IBM System/360 Operating System utility programs and the control statements used with each program. These programs are used by programmers responsible for organizing and maintaining operating system data.

Three types of utility programs are discussed: *system utilities* and *data set utilities*, which operate outside the operating system. System utilities deal with operating system control data. Data set utilities manipulate data sets at the record level and above. Independent utilities initialize, dump, and restore direct-access volumes. (352 pages)

GC28-6590 IBM System/360 Operating System PL/I Subroutine Library Computational Subroutines 29

Program Number: 360S-LM-512

This publication gives details of the computational subroutines available in the PL/I Library. These subroutines are used by the PL/I (F) compiler in the implementation of PL/I built-in functions and of the operators used in the evaluation of PL/I expressions. Not all PL/I built-in functions and expression operators are supported by the PL/I Library; the compiler generates in-line code for a small number of them. The details provided include timing figures, summaries of the mathematical methods used, and (where appropriate) figures for range and accuracy. This information is intended to be of interest chiefly to those programmers concerned with the performance of computational subprograms. (84 pages)

GC28-6594 IBM System/360 Operating System PL/I (F) Programmer's Guide 29

Program Number: 360S-NL-511

The PL/I (F) Compiler translates PL/I source programs into object programs in System/360 machine language. This publication describes the facilities provided by the compiler, and the conventions and restrictions which the user must observe. It explains how to compile, linkage edit, and execute PL/I source programs in the environment of System/360 Operating System. Features of PL/I which are not supported by the (F) Compiler are detailed in Appendix H of this publication. (212 pages)

GC28-6595 IBM System/360 Operating System Assembler (E) Programmer's Guide 21

This publication complements the IBM System/360 Operating System Assembler Language publication. It provides a guide to program assembling, linkage editing, executing, interpreting listings, and assembler programming considerations. (43 pages)

GC28-6596 IBM System/360 FORTRAN IV Library Subprograms 25

*Program Numbers: 360F-LM-619
360N-LM-480*

This publication describes the library subprograms supplied with DOS BASIC FORTRAN IV and FORTRAN IV (DOS and Model 44) and tells how to use the subprograms in either a FORTRAN or an assembler language program. (72 pages)

GC28-6603 IBM System/360 Operating System FORTRAN IV (E) Programmer's Guide 25

Program Number: 360S-FO-092

This publication describes how to compile, link edit, and execute a FORTRAN IV (E) program. The text also describes the output of compilation and execution and how to make optimal use of the compiler and a load module. (118 pages)

GC28-6615 IBM System/360 Operating System ALGOL Language 26

This publication provides the programmer with the information needed to use the IBM System/360 Operating System ALGOL compiler for the solution of scientific and technical problems. ALGOL has been introduced in a number of universities and technical institutes for communication and education purposes. To assist that particular area, the OS/360 ALGOL Compiler is intended to provide a bridge to System/360 for existing ALGOL users. A basic knowledge of the ALGOL language is assumed.

This publication consists of two main parts. The first (section 1 to 5) describes the elements of the ALGOL language, the second (section 6) describes the input/output procedures to be called when using ALGOL. (109 pages)

GC28-6628 IBM System/360 Operating System System Control Blocks 36

This publication shows the formats of the major control blocks and tables used by more than one component of the System/360 Operating System control program. Descriptions of each field within the control blocks or tables follow each format illustration.

The system control blocks described in this publication will be changed by IBM from time to time to extend the capabilities of the operating system. Programs should refer to these control blocks only through the system macro instruction facilities provided in the operating system. (For example, a field of the Data Control Block should only be referred to by use of the DCBD macro instruction.) Programs that refer to the control blocks by other means do so at the risk of not executing correctly in the future. (276 pages)

GC28-6629 IBM System/360 Basic 25
FORTRAN IV Language

This publication describes and illustrates the use of the Basic FORTRAN IV language for the IBM System/360 Operating System, the IBM System/360 Disk Operating System, the IBM System/360 Tape Operating System, and the IBM System/360 Basic Programming Support Tape System. (93 pages)

GC28-6631 IBM System/360 Operating 20
System Messages and Codes

This publication lists and explains the messages, completion codes, and wait state codes produced by all IBM-supplied components of the IBM System/360 Operating System. The introduction shows the formats of the messages and codes, and gives certain information not given in the individual message and code descriptions. The messages and codes are presented in alphanumeric order. (408 pages)

GC28-6632 IBM System/360 Operating 36
System Job Control Language Charts

This publication presents the Job Control Language in a graphic form. Detailed flowcharts describe how to code job control statements for a sequential scheduling system. (67 pages)

GC28-6644 IBM System/360 Operating 20
System Master Index

This publication consolidates the indexes of publications in the IBM Systems Reference Library for the System/360 Operating System. It also provides a reading plan for these publications.

The master index lists topics alphabetically, and refers to publications where these topics are discussed. The indexes of these publications list the same topics and refer to specific pages. (240 pages)

GC28-6646 IBM System/360 Operating 36
System Supervisor and Data Management Services

This publication describes the services and facilities available in the IBM System/360 Operating System when using supervisor and data management macro instructions. It also describes the linkage conventions established for use in the operating system. Macro instructions used for Graphics or Teleprocessing are included in separate publications. Publications relating to Graphics or Teleprocessing are indexed in *IBM System/360 Bibliography*, Order Number GA22-6822.

This publication covers the three main configurations of the operating system: systems with the primary control program; systems that provide multiprogramming with a fixed number of tasks (MFT or Option 2); systems that provide multiprogramming with a variable number of tasks (MVT or Option 4). (160 pages)

GC28-6647 IBM System/360 Operating 36
System Supervisor and Data Management Macro Instructions

This publication defines and describes the supervisor and data management macro instructions available in the IBM System/360 Operating System. The macro instruction descriptions and definitions apply to the three main configurations of the operating system: systems with the primary control program; systems that provide multiprogramming with a fixed number of tasks (MFT or Option 2); and systems that provide multiprogramming with a variable number of tasks (MVT or Option 4).

Descriptions and definitions applying to Graphics or Teleprocessing are included in separate publications. Publications relating to Graphics or Teleprocessing are indexed in *IBM System/360 Bibliography*, Order Number GA22-6822. (270 pages)

GC28-6648 IBM System/360 Operating 37
System TESTRAN

TESTRAN is a facility for testing programs written in the assembler language for execution under the System/360 Operating System. It is intended for use by the individual programmer in testing his own programs.

This publication explains how to use TESTRAN for typical testing purposes, how to write essential job control statements, and how to interpret printed test results. It formally describes TESTRAN statements, cataloged procedures supplied by IBM, and TESTRAN diagnostic messages.

The information in this publication applies to systems that include the primary control program (PCP) and to systems that provide multiprogramming with a fixed number of tasks (MFT or Option 2) or multiprogramming with a variable number of tasks (MVT or Option 4). (96 pages)

GC28-6650 IBM System/360 Operating 37
System Online Test Executive Program

Program Number: 360S-DN-533

This publication describes the Online Test Executive Program, which controls online testing of I/O units under control of the System/360 Operating System. It explains the program's functions and gives procedures for running the tests.

This publication applies to the three main configurations of the operating system: systems with the primary control program (PCP), systems that provide multiprogramming with a fixed number of tasks (MFT), and systems that provide multiprogramming with a variable number of tasks. (28 pages)

C28-6656 IBM System/360 Operating 31
System Checkpoint/Restart

This publication describes the checkpoint/restart facility of the IBM System/360 Operating System, and contains the information necessary for programmers and operators to use the facility.

The checkpoint/restart facility saves job step information at specific checkpoints in a program so that, in the event of error, it can restart the job step from one of the checkpoints. (17 pages)

GC28-6662 IBM System/360 Operating 33
System Sort/Merge Timing Estimates

Program Number: 360S-SM-023

This publication contains total execution times of the Operating System Sort/Merge program for over 30,000 sorting applications. These times are for sorting applications executed on the System/360 Models 30, 40, 50, 65, and 75 with various amounts of main storage assigned to the program. Typical input data set sizes and I/O configurations are shown. (56 pages)

GC28-6670 IBM System/360 Operating 20
System Programmer's Guide to Debugging

This publication describes the major debugging facilities provided with the IBM System/360 Operating System:

1. Abnormal Termination and Snapshot Dumps
2. Indicative Dumps
3. Stand-Alone Hexadecimal Dumps

It explains the aspects of system control pertinent to debugging, tells what each debugging facility offers, and outlines procedures for invoking and interpreting dumps issued at the three control program levels—PCP, MFT, and MVT. (80 pages)

GC28-6676 IBM System/360 Disk 33
Operating System Tape and Disk Sort/Merge Program

Program Number: 360N-SM-483

This publication describes how to use the IBM System/360 Disk Operating System Tape and Disk Sort/Merge Program. It contains the following specifications:

1. Minimum machine environment for sorting or merging records with this program.
2. Program capabilities.
3. Control statements required to define a specific sort or merge application.
4. Facilities provided for inserting user routines in the program.
5. Operating instructions.

For a list of associated publications and their abstracts, see the *IBM System/360 Bibliography*, Order Number GA22-6822. (112 pages)

GC28-6679 IBM System/360 Disk 33
Operating System Tape and Disk Sort/Merge Timing Estimates

Program Number: 360N-SM-483

This publication is intended for those who require execution times for the DOS Tape and Disk Sort/Merge program. Times are shown for sorting applications executed on the System/360 Models 25, 30, 40, and 50. The assumptions under which these times were calculated are described. (68 pages)

GC28-6680 IBM System/360 Operating System Tape Labels 30

This publication describes how the IBM System/360 Operating System processes magnetic tape volumes with standard labels, nonstandard labels, or no labels. Included for the guidance of programmers and operations analysts are discussions of:

1. Label formats and contents.
2. Tape volume layouts.
3. Label processing for input, output, multi-data set, and multi-volume conditions.
4. Tape characteristics.
5. Nonstandard label processing routines and volume label editor routines.
6. Component considerations.
7. Using tape volumes created by other systems.
8. External labels.

(100 pages)

GC28-6691 IBM System/360 Operating System: Operator's Reference 20

This manual tells the computer operator how to use the IBM System/360 Operating System. It presents general operating procedures for using the various types of operator's console configurations. It describes specific operating techniques for each of the three major system types: systems with the primary control program (PCP); systems that provide multiprogramming with a fixed number of tasks (MFT); and systems that provide multiprogramming with a variable number of tasks (MVT). These operating techniques include:

- How to start, stop, and restart the operating system.
- How to control input and output.
- How to control jobs.
- How to understand messages.

This book also presents operating techniques that apply to all three major system types, as well as a discussion of the remote job entry (RJE) and conversational remote job entry (CRJE) facility. Many technical terms are defined. (248 pages)

GC28-6692 IBM System/360 Operating System: Operator's Procedures 20

This book is for the operator of an IBM System/360 Operating system and is to be used with the Operator's Reference, GC28-6691. This book contains procedures for running the three major system types: Primary Control Program (PCP); Multiprogramming with a Fixed number of tasks (MFT); and Multiprogramming with a Variable number of Tasks (MVT). It also contains operator procedures that apply to all three systems. Operator control panel procedures on tear out sheets are provided for the Operator's console. (148 pages)

SC28-6695 IBM System/360 DISK Operating System: Tape and Disk Sort/Merge Program, Systems Reference Library—Program Number 5736-SM1 33

This publication describes how to use the IBM System/360 Disk Operating System Tape and Disk

Sort/Merge Program. It contains the following specifications:

- Minimum machine environment for sorting or merging records with this program.
- Program capabilities.
- Control statements required to define a specific sort or merge application.
- Facilities provided for inserting user routines in the program.
- Operating instructions.

For a list of associated publications and their abstracts, see the IBM System/360 Bibliography, GA22-6822. (116 pages)

GC28-6698 IBM System/360 Operating System: Time Sharing Option Planning for TSO 20

This publication is a planning aid only. It is intended for use by the system manager, system analyst, and system programmer prior to the availability of the Time Sharing Option and will be supplemented with reference documentation when TSO becomes available. This publication describes the concepts, features, and capabilities of TSO. It describes in general what TSO is and what it can do.

Certain of the functions described in this publication are performed by IBM Program Products, available from IBM for a fee. See page three for a list of these products, which are not uniquely identified in the text in all cases. (72 pages)

GC28-6703 IBM System/360 Operating System: Job Control Language User's Guide Systems Reference Library Manual 36

The job control language (JCL) issued with all System/360 Operating System control programs. Every job submitted for execution by the operating system must include JCL statements. These statements contain information required by the operating system to initiate and control the processing of jobs.

This publication contains tutorial information on JCL for programmers. Special emphasis is placed on "how to" perform specific functions using a subset of the JCL statements rather than on describing the full facilities of each statement.

This publication has four parts:

- Part I: Introduction to the job control language—describes how to use each JCL statement.
- Part II: JCL for compilers, linkage editor, and loader—contains a summary of the JCL statements used by those programs and examples of their use.
- Part III: Cataloged and in-stream procedures—describes how to use and write cataloged and in-stream procedures.
- Part IV: Examples of cataloged procedures for compilations, link edits, and executions—contains IBM supplied cataloged procedures for those functions and examples of their use.

After becoming familiar with the information presented in this manual, you may use IBM SYSTEM/360 OPERATING SYSTEM: JOB CONTROL LANGUAGE REFERENCE, GC28-6704 for review and reference. (376 pages)

GC28-6704 IBM System/360 Operating System: Job Control Language Reference 36

The job control language is used with all System/360 Operating System control programs. Every job submitted for execution by the operating system must include job control language statements. These statements contain information required by the operating system to initiate and control the processing of jobs.

This publication describes the facilities provided with the job control language and contains the information necessary to code job control language statements.

This publication is intended for review and reference by programmers who are familiar with the information contained in IBM System/360 Operating System: Job Control Language User's Guide, GC28-6703, or who have experience in using the job control language. (328 pages)

GC28-6708 IBM System/360 Operating System Advanced Checkpoint/Restart Planning Guide 31

This publication describes the advanced checkpoint/restart facility, which allows automatic and deferred job restart at the beginning of a step or at a checkpoint within a step. Emphasis is on planning for the use of this new facility with the PCP and MVT control programs of the IBM System/360 Operating System.

Future releases of the facility will extend support to MFT and Model 65 Multiprocessing. (80 pages)

GC28-6716 IBM System/360 Operating System: Feature Guide 20

This is a guide to optional features of the IBM System/360 Operating System (MVT, MFT and PCP). This publication stresses improving overall system performance; it endeavors to interrelate such factors as operating system programs, application programs, computer equipment, customer operating procedures, customer personnel, and maintenance.

This publication is intended for people who are responsible for improving system performance, such as data processing managers and system programmer/analysts. Knowledge of the IBM System/360 Operating System: Introduction, GC28-6534, and Concepts and Facilities, GC28-6535, is assumed.

For each optional feature, the reader is given the purpose of the feature performance criteria, insights on using the feature, direction toward implementing the feature, and specific references to more detailed data in other IBM and, if applicable, non-IBM publications.

The information contained in this publication concerning the Model 195 is for planning purposes only. (72 pages)

GC28-6719 IBM System/360 Operating 31
System: Service Aids

This publication describes the facilities provided for use in servicing OS/360. The functions provided include inspecting, modifying, mapping, dumping and interpreting the system libraries and main storage areas of System/360.

Each of the Service Aids is described in detail in a separate section of the text. The Service Aids are:

- **IMAPTFLE**—Which produces JCL, tailored to user's system, for use in apply PTF's to system libraries.
- **IMAPTFLS**—Which identifies members of a library to which PTF's or local fixes have been applied.
- **IMASPZAP**—Which allows the user to inspect and modify data on direct access devices.
- **IMBMDMAP**—Which produces formatted maps of load modules previously link edited into a partitioned data set, of link pack or resident reenterable load module areas, and of the nucleus.
- **IMCJQDMP**—Which is a stand-alone program that provides formatted dumps of all or selected queues of the system data set SYS1.SYSJOBQE.
- **IMDSADMP**—Which is a macro, assembled with user-selected options, producing a stand-alone dump program that can dump main storage to tape at high speed, and to either tape or a printer at low speed.
- **IMDPRDMP**—Which uses the high-speed tape output of IMDSADMP to produce a formatted dump listing.

(262 pages)

GC28-6720 IBM System/360 Operating 36
System: MVT Guide

This publication describes the MVT (multiprogramming with a variable number tasks) configuration of the operating system control program. It contains introductory material for programmers not familiar with MVT, planning information storage estimates, information on optimizing performance, and a section on options and facilities available with MVT. (88 pages)

GC28-6733 IBM System/360 Operating 36
System: Release 19 Guide

This publication contains a summary of release 19 of the IBM System/360 Operating System. It describes:

- New and changed system features and requirements.
- System maintenance activity, including APAR descriptions, a program symptom index, and a list of program temporary fixes (PTF's) corrected.
- Modules added, deleted, or modified for release 19.

(376 pages)

GC28-6750 IBM S/360 OS Time Sharing 32
Option TSO Data Utilities: Copy, Format, List, Merge

This Program Product Design Objectives (PPDO) describes the design objectives and provide the estimated availability data of the subject Program Product. (2 pages)

GC28-6752 IBM System/360 Disk 33
Operating System: Tape and Disk Sort/Merge Program, Program No. 5736-5M1

This Program Product Design Objectives (PPDO) describes the design objectives and provides the estimated availability date of the subject Program Product. (1 page)

GC28-6754 IBM System/360 Disk 60
Operating System: Tape and Disk Sort/Merge Program, General Information

Program Number: 5736-SM1

This publication provides general information about the IBM System/360 Disk Operating System: Tape and Disk Sort/Merge Program product. It describes:

- The organization of the program.
- Control statement formats.
- User exit facilities.
- Hardware and storage requirements.
- Label handling requirements.
- Program performance characteristics.

This publication also contains timing estimates for the Tape and Disk Sort/Merge Program. (92 pages)

SC28-6755 IBM System/360 Disk 33
Operating System: Tape and Disk Sort/Merge Program, System Information

Program Number: 5736-SM1

System Information Manual for Program Product. This publication contains the Disk Operating System information that relates to the tape and disk sort/merge program product. It describes:

- Storage, hardware, and program installation requirements
- Procedures to be followed for program installation
- Sample problems which provide a minimal test of the 5736-SM1 sort/merge program.
- Messages generated by the 5736-SM1 sort/merge program

(68 pages)

GC28-6756 IBM System/360: PLANNING 20
For The Use Of Information Interchange Standards OS DOS TSS Systems Reference Library Manual

The ability to interchange information (data) among computer systems (regardless of manufacturer) is a prime concern today. A step towards achieving interchange is attained by using a standard code, and standard tape labels and record formats.

Additional programming support will be provided in three operating systems — OS, DOS, and TSS — to allow users to create and process data for information interchange.

The information in this publications is for PLANNING purposes only and will be replaced by the necessary reference information when IBM programming support for the Information Interchange Standards becomes available. (52 pages)

GC28-6758 System/360 OS Dam 95
Set Utilities Support for ASCII Program Product - PPDO

This Program Product Design Objectives (PPDO) describes the design objectives and provides the estimated availability date of the subject Program Product.

SC28-6808 A Programming Language/ 95
One Primer

The purpose of this publication is to provide tutorial material not only for the person with some knowledge of computer programming, but also for the novice who knows little or nothing about data processing.

The first chapter is written solely for the novice. A reader who is familiar with basic programming techniques should skip the first chapter, and begin reading at Chapter 2, "Basic Elements of PL/I."

Chapter 1, "Communicating with a Computer," touches on machine language and introduces the concept of symbolic programming. The basic techniques of programming are illustrated by using symbolic instructions, rather than PL/I, because certain PL/I statements can generate so much single-instruction coding that the details of some of the techniques are hidden.

Further information concerning PL/I can be found in the following publications: *IBM Operating System/360 PL/I Language Specifications*, Order Number GC28-6571; *A Guide to PL/I for FORTRAN Users*, Order Number SC20-1637. (76 pages)

GC28-6810 IBM System/360 Model 44 20
Programming System Concepts and Facilities

This publication describes the facilities provided by the IBM System/360 Model 44 Programming System.

The Model 44 Programming System consists of a FORTRAN compiler, an assembler, a supervisor, and system support programs. It provides FORTRAN and assembler language processing and program execution in a monitored environment, with automatic job-to-job transition, interruption handling, and input/output supervision. The system has facilities for the creation and maintenance of libraries and the manipulation of their contents. It also provides extensive job control and program segmentation capabilities for flexibility and versatility in the preparation of programs for execution. (47 pages)

- GC28-6811 IBM System/360 Model 44 21**
Programming System Assembler Language
 This publication contains specifications for the IBM System/360 Model 44 Programming System Assembler Language.
 This assembler language is used to write programs for the Model 44. The IBM System/360 Model 44 Programming System Assembler Program processes the language and provides auxiliary functions useful in the preparation and documentation of a program. (73 pages)
- GC28-6812 IBM System/360 Model 44 36**
Programming System Guide to System Use
 This publication contains detailed information for preparing programs to be executed under the IBM System/360 Model 44 Programming System. It discusses and illustrates the system's requirements, its capabilities, and the control statements and supervisor calls that are used with it.
 A prerequisite publication is the *IBM System/360 Model 44 Programming System: Concepts and Facilities*, Order Number GC28-6810, (37 pages)
- GC28-6813 IBM System/360 Model 44 25**
Programming System Guide to System Use for FORTRAN Programmers
 This publication describes how to use the Model 44 Programming System to compile and execute programs written in the IBM System/360 FORTRAN IV language. A discussion of program optimization and of the restrictions of the Model 44 FORTRAN IV compiler is also included.
 This publication is directed primarily at programmers who are familiar with the FORTRAN IV language. Previous knowledge of the Model 44 Programming System is not required. (111 pages)
- GC28-6814 IBM System/360 Model 44 36**
Programming System—Systems Programmer's Guide
 This publication describes how to construct an IBM System/360 Model 44 Programming System, and how to modify and extend its capabilities.
 Among the subjects discussed in this publication are:
 1. How to construct and edit a Model 44 Programming System.
 2. How to write an accounting routine and incorporate it into the system.
 3. How to define the input/output configuration at IPL time.
 4. How to write routines at the Execute Channel Program (EXCP) level of the input/output facilities.
 5. How to expand the user communication region.
 6. How to update the module and phase libraries.
 7. How to print, punch, and update the distributed tape reel. (86 pages)
- GC28-6815 IBM System/360 Model 44 36**
Programming System Operator's Guide
 This publication provides operators with detailed information required for operating the IBM System/360 Model 44 Programming System and the various stand-alone programs associated with it.
 Operating instructions are provided for IPL procedures, general operations, abnormal end procedures, operator-to-system communications, and stand-alone operations. (40 pages)
- GC28-6816 IBM System/360 Conversion 35**
Aids: 1620 Simulator for IBM System/360 Model 44
Program Number: 360C-SI-755
 This reference publication provides information on the 1620 simulator for the IBM System/360 Model 44, and is directed to the user who is replacing his IBM 1620 Model 1 or Model 2 Data Processing System with an IBM System/360 Model 44. This manual describes the installation requirements, and programming and operating considerations for the 1620 simulator.
 Simulation is a technique that uses System/360 instruction sequence to perform the functions of 1620 instructions, thus permitting the user to execute object programs written for the 1620. (56 pages)
- GC28-6817 IBM System/360 Operating 25**
System FORTRAN IV (G and H) Programmer's Guide
Program Numbers: 360S-FO-500 360S-FO-520
 This publication explains how to compile, linkage edit, and execute a program written in IBM System/360 FORTRAN IV Language. (180 pages)
- GC28-6818 IBM System/360 25**
FORTRAN IV Library: Mathematical and Service Subprograms
Program Number 360S-LM-501
 This publication describes the mathematical and service subprograms contained in the library supplied with Basic FORTRAN IV (OS) and FORTRAN IV(OS) compilers. Information on the use of these subprograms in either a FORTRAN or an assembler language program is also included. (67 pages)
- GC28-6820 IBM System/360 OS 29**
Interactive Terminal Facility: PL/I and Basic 5734-RC1, 5734-RC3
 00000100 This Program Product Design Objectives (PPDO) describes the design objectives and provides the estimated availability date of the subject Program Product.
 00000200
 00000300 (4 pages)
- GC28-6821 IBM System/360 DOS 29**
Interactive Terminal Facility: PL/I and Basic
 This Program Product Design Objectives (PPDO) describes the design objectives and provides the estimated availability date of the subject Program Product. (4 pages)
- GC28-6824 IBM System/360 Operating 25**
System FORTRAN Program Products for OS and OS with TSO General Information Program Product Manual
 This publication describes the FORTRAN program products developed to operate under the Time Sharing Option (TSO) of the IBM System/360 Operating System. Included are discussions of the Code and Go FORTRAN processor, the FORTRAN IV (G1) processor, the TSO FORTRAN Prompter, and the FORTRAN IV Library (Mod 1).
 This publication is intended as an aid to evaluation and planning and is not meant for the terminal user; terminal user publications will be provided when TSO becomes available. (16 pages)
- GC28-6825 IBM System/360 OS/DOS 29**
ITF: PL/I General Information
Program Numbers: 5734-RC1 5736-RC1
 This publication gives general information about the external characteristics of the PL/I feature of the Interactive Terminal Facility (ITF), a Program Product that operates under the System/360 Operating System (OS) or the System/360 Disk Operating System (DOS). The book includes descriptions of terminal commands, PL/I language elements and machine requirements.
 This publication is intended as an aid to evaluation and planning; it is not meant for the terminal user. (26 pages)
- GC28-6826 IBM System/360 OS/DOS 23**
ITF: Basic General Information
Program Numbers: 5734-RC3 5736-RC2
 This publication gives general information about the external characteristics of the BASIC feature of the Interactive Terminal Facility (ITF), a Program Product that operates under the System/360 Operating System (OS) or the System/360 Disk Operating System (DOS). The book includes descriptions of terminal commands, BASIC language elements, and machine requirements.
 This publication is intended as an aid to evaluation and planning; it is not meant for the terminal user. (26 pages)
- GC28-6829 IBM System/360 OS 29**
Interactive Terminal Facility: PL/I & Basic
 This Program Product Specifications (PPS) describes the warranted specifications of the subject Program Product. (4 pages)

GC28-6830 IBM System/360 Disk 29
Operating System, Interactive Terminal Facility: PL/I and Basic

This Program Product Specifications (PPS) describes the warranted specifications of the subject Program Product. (4 pages)

SC28-6833 IBM System/360 OS/DOS 29
ITF: PL/I Introduction

*Program Numbers: 5734-RC1
5734-RC3
5736-RC1
5736-RC2*

This publication is an introduction to the IBM System/360 Operating System (OS) and the IBM System/360 Disk Operating System (DOS) Interactive Terminal Facility: PL/I. It is designed to give a novice programmer the tools he needs to write elementary programs in ITF: PL/I and to enable him to understand the more advanced material found in related publications. Because of this limited scope, therefore, this publication does not cover all the capabilities of ITF: PL/I nor does it include all the detailed information on system and terminal operation. These details may be found in the *IBM System/360 Operating System and IBM System/360 Disk Operating System Interactive Terminal Facility: PL/I Terminal User's Guide*, Order Number SC28-6834. (62 pages)

SC28-6834 IBM System/360 OS/DOS 29
ITF: PL/I Terminal User's Guide

*Program Numbers: 5734-RC1
5734-RC3
5736-RC1
5736-RC2*

This publication provides tutorial information and reference material for users of the PL/I language component of the Interactive Terminal Facility (ITF), a Program Product that operates under the System/360 Operating System (OS) or the System/360 Disk Operating System (DOS).

The book tells how to use ITF and how to write programs in ITF:PL/I; it also includes detailed descriptions of the ITF:PL/I language elements, the ITF system commands, as well as error recognition and correction information. Sample programs and examples of the use of ITF:PL/I appear throughout the text.

This publication is intended for the ITF:PL/I terminal user. Users with little or no programming experience should be thoroughly familiar with the concepts presented in the publication *IBM System/360 OS/DOS ITF:PL/I Introduction*, SC28-6833. (232 pages)

SC28-6835 IBM System/360 OS/DOS 23
ITF: Basic Terminal User's Guide

*Program Numbers: 5734-RC1
5734-RC3
5736-RC1
5736-RC2*

This publication provides tutorial information and reference material for users of the BASIC language

component of the Interactive Terminal Facility (ITF), a Program Product that operates under the System/360 Operation System (OS) or the System/360 Disk Operating System (DOS).

The book tells how to use ITF, and how to write programs in BASIC; it also includes detailed descriptions of the BASIC language elements, the ITF system commands, as well as error recognition and correction. Sample programs and examples of the Use of ITF:BASIC appear throughout the text.

This publication is intended for the ITF:BASIC terminal user. No previous knowledge of programming or of the BASIC language is required. (164 pages)

SC28-6836 IBM System/360 OS/DOS 31
ITF Installation Reference Material

*Program Numbers: 5734-RC1
5734-RC3
5736-RC1
5736-RC2*

This publication describes the information required by the central computing installation to run the Interactive Terminal Facility (ITF). This includes machine requirements, and operator commands.

ITF runs as a problem program under either the System/360 Operating System (OS) or the System/360 Disk Operating System (DOS). It supports conversational problem solving in the ITF:PL/I and/or ITF:BASIC language. (138 pages)

GC28-6837 BASIC Language Reference 23
Manual

This publication contains a complete description of the BASIC programming language as it is defined by IBM.

BASIC is a terminal-oriented language used by both programmers and non-programmers for the solution of problems requiring lengthy or repetitive computations.

The syntax and semantics of BASIC are presented in this publication for readers who are already acquainted with the fundamental techniques and terminology of programming. Topics covered include program structure, data representation, and statement descriptions. Sample BASIC programs and a formalized definition of the language is included in appendixes. (114 pages)

GC28-6844 IBM System/360 - 25
OS FORTRAN IV Library (Mod I) PPDO

This Program Product Design Objectives (PPDO) describes the design objectives and provides the estimated availability date of the subject Program Product.

GC28-6846 IBM System/360 25
OS FORTRAN IV (H Extended) Compiler PPDO

This Program Product Design Objectives (PPDO) describes the design objectives and provides the estimated availability date of the subject Program Product.

GC28-6847 IBM System/360 25
OS FORTRAN IV Library (Mod II) PPDO

This Program Product Design Objectives (PPDO) describes the design objectives and provides the estimated availability date of the subject Program Product.

GC28-6848 IBM System/360 Operating 25
System FORTRAN IV (H Extended) Compiler and FORTRAN IV Library (Mod II) General Information

*Program Numbers: 5734-FO3
5734-LM3*

This publication gives general information about the external characteristics of the FORTRAN IV (H Extended) compiler, a program product that operates under the System/360 Operating System. Included here are brief descriptions of the compiler's features, as well as information on operating system requirements and machine configuration. Information is also provided about the FORTRAN IV Library (Mod II), a program product that supports the FORTRAN IV (H Extended) compiler.

This publication is intended as an aid in evaluation and planning; it is not meant for the FORTRAN programmer. Publications for the FORTRAN programmer will be provided when the FORTRAN IV (H Extended) compiler and the Mod II Library become available. (10 pages)

GC28-8193 DOS/360 FORTRAN IV 24
Library ASCII Support PPDO

This Program Product Design Objectives (PPDO) describes the design objectives and provides the estimated availability date of the subject Program Product.

GC28-8201 IBM System/360 29
PL/I Reference Manual

This publication provides the rules for writing PL/I programs that are to be compiled using the PL/I F-level compiler under the IBM System/360 Operating System. It is not a reference to the entire language, but only to those features implemented by the third version of the F-level compiler. (312 pages)

GC28-8202 IBM System/360 29
PL/I Subset Reference Manual

This publication provides the rules for writing PL/I Subset programs that are to be compiled using the PL/I D-level compiler under the IBM System/360 Disk and Tape Operating Systems. It is not a reference to the entire PL/I Subset language, but only to those features implemented by the second version of the D-level compiler. (232 pages)

GC30-2003 IBM System/360 Operating 30
System Queued Telecommunications
Access Method—Message Processing
Program Services

This publication provides information on how to use the Queued Telecommunications Access Method (QTAM) within Option 2 (Multiprogramming with a Fixed Number of Tasks) of the System/360 Operating System, to support a telecommunications application. Services provided by QTAM in support of a message processing program are described in detail, including the facilities provided to establish the interface to a QTAM message control program.

For detailed information on the QTAM facilities provided for the construction of a message control program, refer to the publication, *IBM System/360 Operating System, QTAM Message Control Program*, Order Number GC30-2002. (22 pages)

GC30-2004 IBM System/360 Operating 30
System Basic Telecommunications
Access Method

Program Number: 360S-CQ-513

This publication describes the Basic Telecommunications Access Method (BTAM) available with the System/360 Operating System. BTAM provides facilities that enable an assembler-language programmer to write a teleprocessing control program that effects communications at the read/write level between a System/360 and a variety of computers and terminals connected to the System/360 over common-carrier or private-wire communications network. BTAM employs both start-stop and binary synchronous (BSC) communications techniques, depending on the type of remote station.

Typical BTAM applications include data acquisition, message switching, and inquiry processing.

The publication explains some concepts of teleprocessing and BTAM, describes line control and message transmission techniques, and describes each of the BTAM macro instructions and facilities needed to construct a control program. The READ and WRITE macro instructions applicable for each type of remote station line configuration are given, along with the channel programs generated for each type.

A prerequisite for use of this publication is a knowledge of System/360 assembly language and data management facilities. (210 pages)

GC30-2005 IBM System/360 Operating 30
System Queued Telecommunications
Access Method Message Control
Program

This publication contains specifications on the use of the Queued Telecommunications Access Method (QTAM) and the IBM System/360 Operating System to support telecommunications applications. Information in this publication will facilitate the construction of a QTAM message control program by the problem programmer. Complete descriptions of QTAM macro instructions are included.

For detailed information on the services provided by QTAM to support a message processing program, refer to *IBM System/360 Operating System: QTAM Message Processing Program Services*, Order Number GC30-2003. (176 pages)

GC30-2006 IBM System/360 Operating 36
System Remote Job Entry

Program Number: 360S-RC-536

This publication is designed to present the general concepts and facilities of Remote Job Entry (RJE). RJE allows users at remote locations to submit jobs over communications lines to an IBM System/360. It is available to users with either multiprogramming version of the IBM System/360 Operating System: multiprogramming with a variable number of tasks (MVT) or multiprogramming with a fixed number of tasks, version 2 (MFT).

Information on the capabilities and uses of RJE, on operating environments, and on work station states activities is included for the systems programmer and operator. The Job Entry Control Language is introduced and explained. The Job Entry Definition Statement, work station commands, messages sent to work stations, and central commands are discussed in terms of their functions, and how the user employs them in programs.

A discussion of RJE generation includes the necessary macro instructions. Communication Serviceability Facilities, such as error recovery procedures, and system restart procedures, are discussed separately as well as with the work stations.

A discussion of programming information for the 2780 Data Transmission Terminal and for the 1130 Computing System is included. (124 pages)

GC30-2007 IBM System/360 30
Introduction to Teleprocessing

This publication provides computer applications analysts and programmers with an introduction to Teleprocessing. Following a historical survey and some brief application descriptions is a review of equipment characteristics and programming techniques. Introductory material on two levels of IBM System/360 Teleprocessing programming support is then presented. A bibliography and a technical glossary conclude the publication. (40 pages)

GC30-2009 IBM System/360 Operating 30
System Basic Telecommunications
Access Method Planning for Use of
the IBM 2741 Under BTAM

Program Number: 360S-CQ-513

This publication is for planning purposes only. It may be used by applications programmers in preparing for support for the IBM 2741 Communications Terminal by the Basic Telecommunications Access Method (BTAM) under the Operating System. The terminal and the control discipline used in terminal-to-computer communication are described, as are the BTAM functions used for the 2741 (with emphasis on Read and Write operations), and how to design a problem program.

The information in this publication supplements that in the publication *System/360 Operating System, Basic Telecommunications Access Method*, Order Number GC30-2004, with which the reader is expected to be familiar. (14 pages)

GC30-2010 IBM System/360 Operating 36
System Planning for Conversational
Remote Job Entry

This publication is a planning aid only. It is intended for use *prior* to the availability of Conversational Remote Job Entry (CRJE) and shall be replaced by reference documentation when CRJE becomes available.

The information in this publication represents current implementation plans, which are subject to modification during the period between announcement and availability of CRJE.

This publication contains a general description of CRJE and the facilities it provides users at remote keyboard terminals attached by communication lines to an IBM/360 using the Operating System that provides multiprogramming with a variable or fixed number of tasks.

Information about the CRJE task, its operating environment, and how to include an installation-tailored CRJE facility in the operating system is provided for the system programmer.

A discussion of the central operator capabilities includes a description of central commands. Terminal user considerations include the terminal command language and how it enables users to prepare and enter jobs for batch processing at the central installation. Central operator messages and terminal messages are documented with explanations and suggested operator or user responses. (88 pages)

GC30-2012 IBM System/360 Operating 36
System: Conversational Remote Job
Entry Concepts and Facilities

This publication describes the basic concepts of Conversational Remote Job Entry (CRJE) and guides the CRJE user—system programmer, system manager, terminal user, central operator—in the use of its facilities.

Conversational Remote Job Entry provides Remote Job Entry capability for users at remote keyboard terminals attached by communication lines to a IBM System/360 Operating System that provides multiprogramming with a fixed or variable number of tasks. (32 pages)

GC30-2014 IBM System/360 Operating 36
System Conversational Remote Job
Entry Terminal User's Guide

The Conversational Remote Job Entry (CRJE) Terminal User's Guide serves primarily as a guide for the inexperienced CRJE user and as a reference for the experienced CRJE user.

The Guide describes the functions of CRJE and the terminal commands that enable the user to perform these functions. The commands and sub-commands are described in detail, and examples illustrate how they may be used. Terminal messages are documented with explanations and corresponding system and user responses. (112 pages)

GC30-2016 IBM System/360 Operating System Conversational Remote Job Entry System Programmer's Guide 36

This publication contains information to aid the system programmer and the operator at the central installation in the installation, operation, and use of Conversational Remote Job Entry (CRJE).

This publication describes CRJE and the facilities it provides users at remote keyboard terminals attached by communication lines to an IBM System/360 that uses the Operating System to provide multiprogramming with a variable or fixed number of tasks.

Information about the CRJE task, its operating environment, system generation considerations, and the central operator command facility is included. Central messages are described with explanations and suggested operator responses.

This publication also includes a discussion of CRJE storage estimates and offers some performance guidelines to aid the system programmer in using his CRJE System. (84 pages)

GC30-5001 IBM System/360 Disk Operating System Basic Telecommunications Access Method 30

Program Number: 360N-CQ-469

This publication describes the Basic Telecommunications Access Method (BTAM) used with the System/360 Disk Operating System (DOS) control program, BTAM provides READ/WRITE level macro instructions for the assembler-language programmer who is implementing programs for telecommunications applications.

Included are macro instruction formats and descriptions and specific information on device-dependent considerations.

For titles and abstracts of associated publications see the *IBM System/360 Bibliography*, Order Number GA22-6822. (192 pages)

GC30-5003 IBM System/360 Disk Operating System—QTAM Message Processing Program Services 30

This reference publication provides information on the use of the Queued Telecommunications Access Method (QTAM) and the System/360 Disk Operating System for a telecommunications application. Services provided by QTAM in support of a message processing program are described in detail, including the facilities provided to establish the interface to a QTAM message control program.

The QTAM facilities provided for the construction of a message control program are presented in the publication *IBM System/360 Disk Operating System, QTAM Message Control Program*, Order Number GC30-5004.

For titles and abstracts of other associated publications, see the *IBM System/360 Bibliography*, Order Number GA22-6822. (36 pages)

GC30-5004 IBM System/360 Disk Operating System QTAM Message Control Program 30

Program Number: 360N-CQ-470

This reference publication contains specifications for the use of the Queued Telecommunications Access Method (QTAM) and of the IBM System/360 Disk Operating System in a telecommunications application. Complete descriptions of QTAM macro instructions are included along with information to aid the problem programmer in constructing a QTAM message control program.

For detailed information on the services provided by QTAM to support a message processing program, refer to the publication *IBM System/360 Disk Operating System, QTAM Message Processing Program Services*, Order Number GC30-5003.

For titles and abstracts of other associated publications, see *IBM System/360 Bibliography*, Order Number GA22-6822. (192 pages)

GC33-0001 PL/I Optimizing Compiler PPDO

This Program Product Design Objectives (PPDO) describes the design objectives and provides the estimated availability date of the subject Program Product.

C33-0002 IBM System/360 Operating System PL/I (F) Version 5 Planning Guide 29

This publication is a planning aid only. It is intended for use prior to the availability of the fifth version of the PL/I (F) Compiler and is to be replaced by reference documentation when that compiler becomes available.

Used in conjunction with the publication *IBM System/360 PL/I Reference Manual*, Order Number GC28-8201, this publication enables the user to write PL/I programs that are to be compiled using the fifth version of the F Compiler under the IBM System/360 Operating System. (36 pages)

GC33-0003 IBM System/360 OS, PL/I Checkout Compiler General Information 29

This publication contains a description of the PL/I Checkout Compiler for the IBM System/360 Operating System.

The subjects covered include the compiler facilities, its conversational features, a summary of the PL/I language implemented, and the system environment. The appendixes contain a list of keywords, a comparison with the PL/I (F) Compiler, and a discussion of the PL/I Checkout Compiler and the PL/I Optimizing Compiler as a pair. (48 pages)

GC33-0004 IBM System/360 Disk Operating System PL/I Optimizing Compiler General Information 29

Program Number: 5764-PL1

This publication is a planning aid only. It is intended for use prior to the availability of the following IBM System/360 program products:

- DOS PL/I Optimizing Compiler, Program Product 5736-PL1
- DOS PL/I Resident Library, Program Product 5736-LM4
- DOS PL/I Transient Library, Program Product 5736-LM5

Used in conjunction with the program product publication *IBM System/360 Disk Operating System PL/I Language Reference Manual*, Order Number SC33-0005, this publication enables installation managers, systems analysts, and programmers to plan and write PL/I programs that are to be compiled and executed upon availability of these program products. (44 pages)

SC33-0005 IBM System/360 Disk Operating System PL/I Optimizing Compiler Language Reference Manual (Preliminary) 29

Program Number: 5736-PL1

This publication is designed for the user who already has a knowledge of the PL/I language and who requires a source of reference material for the language implemented by the PL/I Optimizing Compiler. It is intended for use prior to the availability of the compiler.

The publication is in two parts. Part I contains discussions of the concepts of the language. Part II contains detailed rules and syntactic descriptions.

Used in conjunction with the publication *IBM System/360 Disk Operating System: PL/I Optimizing Compiler General Information Manual*, Order Number GC33-0004, this publication enables installation managers, systems analysts, and programmers to plan and write PL/I programs that are to be compiled using the PL/I Optimizing Compiler under IBM System/360 Disk Operating System. (408 pages)

SC33-0009 IBM System/360 Operating System PL/I Language Reference Manual (Preliminary) Program Product Documentation 29

*Program Numbers: 5734-PL1
5734-PL2*

This publication is designed for the user who already has a knowledge of the PL/I language and who requires a source of reference material for the language implemented by the PL/I checkout and optimizing compilers. It is intended for use prior to the availability of these compilers.

The publication is in two parts. Part I contains discussions of the concepts of the language, Part II contains detailed rules and syntactic descriptions.

Used in conjunction with the appropriate general information manuals, this publication enables installation managers, systems analysts, and programmers to plan and write PL/I programs that are to be processed by these compilers. (440 pages)

- GC33-0010 PL/I DOS Compiler PPDO 29**
This Program Product Design Objectives (PPDO) describes the design objectives and provides the estimated availability date of the subject Program Product.
- GC33-0011 PL/I DOS Resident Library PPDO 29**
This Program Product Design Objectives (PPDO) describes the design objectives and provides the estimated availability date of the subject Program Product.
- GC33-0012 PL/I DOS Transient Library PPDO 29**
This Program Product Design Objectives (PPDO) describes the design objectives and provides the estimated availability date of the subject Program Product.
- GC33-0013 PL/I OS Compiler PPDO 29**
This Program Product Design Objectives (PPDO) describes the design objectives and provides the estimated availability date of the subject Program Product.
- GC33-0014 PL/I OS Resident Library PPDO 29**
This Program Product Design Objectives (PPDO) describes the design objectives and provides the estimated availability date of the subject Program Product.
- GC33-0015 PL/I OS Transient Library PPDO 29**
This Program Product Design Objectives (PPDO) describes the design objectives and provides the estimated availability date of the subject Program Product.
- GC33-0028 IBM System/360 & System/370 OS PL/I Checkout Compiler 29**
This Program Product Design Objectives (PPDO) describes the design objectives and provides the estimated availability date of the subject Program Product. (4 pages)
- GC33-2000 IBM System/360 Conversion Aids: The 1410/7010 Simulator for IBM System/360 35**
Program Number: 360C-CV-711
The System/360 ALGOL-to-PL/I Language Conversion Program (LCP) assists in the transition to PL/I by converting System/360 Operating System ALGOL programs into PL/I programs. The LCP itself is written in System/360 Operating System PL/I language. It is distributed in object module form for inclusion in the user's system library.
The user should have an understanding of the System/360 Operating System and be familiar with the following publications:
IBM System/360 Operating System, ALGOL Language, Order Number GC28-6615.
IBM System/360 Operating System, ALGOL Programmer's Guide, Order Number GC33-4000.
IBM System/360 Operating System, PL/I (F) Programmer's Guide, Order Number GC28-6594.
IBM System/360 PL/I Reference Manual, Order Number GC28-8201. (68 pages)
- GC33-2001 IBM System/360 Conversion Aids: COBOL-to-PL/I Language Conversion Program for IBM System/360 Operating System—Preliminary Specifications 29**
The System/360 COBOL-to-PL/I Language Conversion Program (LCP) assists in the transition to PL/I by converting System/360 Operating System COBOL programs compilable by the E and F level compilers into PL/I (F) programs. The LCP itself is written in System/360 Operating System PL/I Language. It is distributed in object module form for inclusion in the user's system library.
The user should have an understanding of the System/360 Operating System and be familiar with the following publications:
Common Business Oriented Language (COBOL), General Information, Order Number GF28-8053.
IBM System/360 Operating System, (COBOL Language), Order Number GC28-6516.
IBM System/360 Operating System, PL/I (F) Programmer's Guide, Order Number GC28-6594.
IBM System/360 Operating System, COBOL (F) Programmer's Guide, Order Number GC28-6380.
IBM System/360, PL/I Reference Manual, Order Number GC28-8201.
A Guide to PL/I for Commercial Programmers, Student Text, Order Number SC20-1651. (80 pages)
- GC33-2002 IBM System/360 Conversion Aids: FORTRAN IV-to-PL/I Language Conversion Program for IBM System/360 Operating System 29**
Program Number: 360C-CV-710
The System/360 FORTRAN IV-to-PL/I Language Conversion Program (LCP) assists in the transition to PL/I by converting FORTRAN IV programs into PL/I programs. The LCP is distributed in object module form for inclusion in the user's system library.
The user should have an understanding of the System/360 Operating System and be familiar with the following publications:
IBM System/360 FORTRAN IV Language, Order Number GC28-6515.
IBM System/360 Basic FORTRAN IV Language, Order Number GC28-6629.
IBM System/360 Operating System, PL/I (F) Programmer's Guide, Order Number GC28-6594.
A Guide to PL/I for FORTRAN Users, Order Number SC20-1637.
IBM System/360, PL/I Reference Manual, Order Number GC28-8201. (76 pages)
- GC33-2003 IBM System/360 Conversion Aids: The 1410/7010 Simulator for IBM System/360 35**
Program Number: 360C-SI-754
This document provides information on the 1410/7010 Simulator for the IBM System/360, and is directed to the user who is replacing his IBM 1410/7010 Data Processing System with an IBM System/360 Model 40, 50, 65, or 75. Simulation is a technique which uses System/360 instruction sequences to perform the functions of 1410/7010 instructions, thus permitting the user to execute object programs written for the 1410/7010. (60 pages)
- GC33-2004 Emulating the IBM 1401, 1440, and 1460 on the IBM System/370 Model 155 using DOS/360 35**
This publication provides planning information for the IBM 1401/1440/1460 Emulator Program for the IBM System/370 Model 155. The emulator program is executed as a problem program under control of the IBM System/360 Disk Operating System on an IBM System/370 Model 155 equipped with the IBM Compatibility Feature (#3950). Using the program and the compatibility feature, the Model 155 can execute programs written for the IBM 1401, 1440, and 1460 Data Processing Systems.
The information in this publication is intended for installation personnel responsible for selecting, evaluating, and implementing IBM System/370 Model 155 configurations. (80 pages)
- GC33-2005 Emulating the IBM 1410 and 7010 on the IBM System/370 Model 155 using DOS/360 35**
This publication provides planning information for the IBM 1410/7010 Emulator Program for the IBM System/370 Model 155. The emulator program is executed as a problem program under control of the IBM System/360 Disk Operating System on an IBM System/370 Model 155 equipped with the IBM Compatibility Feature (#3950). Using the program and the compatibility feature, the Model 155 can execute programs written for the IBM 1410 and 7010 Data Processing Systems.

The information in this publication is intended for installation personnel responsible for selecting, evaluating, and implementing IBM System/370 Model 155 configurations. (64 pages)

GC33-4000 IBM System/360 26
Operating System ALGOL
Programmer's Guide

Program Numbers:
 360S-AL-531—Compiler
 360S-LM-532—Library Routines

This publication describes how to compile, linkage edit and execute a program written in the System/360 Operating System Algorithmic Language (ALGOL). It includes an introduction to the operating system and a description of the information listings that can be produced, the job control language, and the subroutine library. (63 pages)

GC33-4005 IBM System/360 Operating 33
System Sort/Merge

Program Number: 5734-SM1

This Program Product Design Objectives (PPDO) describes the design objectives and provides the estimated availability data of the subject Program Product. (2 pages)

GC33-4014 IBM System/360 21
Operating System Assembler (E)
Installation Guide

This publication contains information needed for incorporating the Assembler (E) contained in the Assembler (E) Independent Component Release Package into the Operating System. It describes the distribution tape and gives detailed instructions for including the component into the system. The publication is intended for system support personnel with a good knowledge of the IBM System/360 Operating System. (12 pages)

GC33-4015 IBM System/370 33
Model 155 Sort/Merge Timing
Estimates Planning Guide

This publication gives estimated execution times of the sort/merge program (360S-SM-023) on the IBM System/370 Model 155 Central Processing Unit. Times are shown for sorting applications using various main-storage sizes and record lengths. The assumptions made in calculating the timing estimates are described. (120 pages)

GC33-5000 IBM System/360 Disk 32
Operating System ASCII
Magnetic Tape Utilities

Program Number: 5736-UT2

This Program Product Design Objectives (PPDO) describes the design objectives and provides the estimated availability data of the subject Program Product. (2 pages)

GC50-0001 The IBM 2701 Data 13
Adapter Unit and ASCII
AUTODIN Adapter RPQ F 16124
Principles of Operations

This manual provides information concerning the operation of the IBM 2701 Data Adapter Unit and the ASCII Adapter RPQ F 16124. The manual is divided into five sections, a glossary, and six annexes.

The first section gives a general description of the 2701 and the AUTODIN Adapter, the functional organization of the 2701 and the configuration of the 2701.

The second section describes the operation of the 2701 with System/360 Model 20. Subjects discussed here include communications line addressing, channel operation, and I/O instructions concerning the 2701 for the Model 20.

The third section describes the operation of the 2701 with System/360 for Models 30 and above. Subjects discussed here include communications line addressing, multiplexor and selector channel operation, and I/O instructions concerning the 2701 for Models 30 and above.

The fourth section covers the ASCII AUTODIN Adapter. A complete description of the operation of the adapter is made which includes transmit and receive operation sequences, status and sense bytes, line interfaces, and the operators panel.

The fifth section covers the operating procedures of the 2701 Data Adapter Unit and the ASCII AUTODIN Adapter.

The glossary contains definitions of certain terms used in this manual which may not be in common use.

The annexes include charts on the ASCII code, representation of the ASCII code to System/360 codes, specifications on the 2701, and two electrical interface drawings. (48 pages)

GE20-0022 Public Utility Customer 60
Accounting with the IBM System/
360 Online Communication System
DP Application Manual

This manual describes an online customer accounting and customer service system using direct access storage devices and terminals. The system provides for: customer inquiries, service orders, transmission of payments, offline batch billing, and accounts receivable processing. (36 pages)

GE20-0188 Retail IMPACT— 60
Inventory Management Program
and Control Techniques—
Application Description

The purpose of this manual is to describe the Retail IMPACT System for the retail industry. The Retail IMPACT System actually consists of two separate systems, one for staple and one for fashion merchandise. Either or both of these systems may be implemented. Programs for the systems are enumerated in the manual.

The manual is divided into chapters which cover topics such as: a general statement of the problems of retail inventory management; simulation, and its uses; ordering parameters, methods of forecasting and forecasting techniques; record

maintenance, purchase order generation and operating and management reporting; design considerations; and implementation. Where appropriate, these topics are discussed separately for the fashion and staple systems. Also, graphs and report examples supplement the text, and a glossary of terms peculiar to the retail environment is included in the manual. (104 pages)

GE20-0228 Optimum Bond Bidding 60
User's Manual

Program Number: 360A-FI-06X

This program has been designed to help underwriters determine the coupon schedule and associated values for a bid on a new bond issue. A mathematical procedure is used which develops an optimal set of coupon rates. The optimization procedure minimizes the net interest cost or effective rate whichever is applicable, while remaining within the constraints established by the issuer and those established by the underwriter. A number of options are provided which help the user obtain bidding information for issues with various characteristics.

This manual contains a general description of the program, including all mathematical formulas, machine configuration, general systems chart, input/output description, sample problem, operating instructions, and halt and message list.

The manual is so structured that the user may concentrate on sections germane to his interest. (119 pages)

GE20-0246 Demand Deposit Accounting 60
Application Description

Program Number: 360A-FB-15X

This manual describes the scope and capabilities of System/360 Demand Deposit Accounting. It covers (1) requirements for a demand deposit application in either a single-bank or multi-bank environment, (2) results from and advantages of using the application programs, (3) accomplishments of each program, (4) information on getting started, (5) record layouts and reports produced, and (6) machine requirements, sample timings, and disk pack requirements. (36 pages)

GE20-0256 IBM System/360 Text 60
Processor COMPOSITION/360—
Application Description

This manual discusses one component application program, which forms the basis for a comprehensive text composition system.

COMPOSITION/360 acts in conjunction with user-supplied programs and the full facilities of the Disk Operating System for System/360. It consists of control and functional routines that accept input from a user-prepared disk-resident file, produces generalized justified output records, and stores them in a specified disk area. If word division capabilities are required, the HYPHENATION/360 program is linked with COMPOSITION/360. (32 pages)

GE20-0257 IBM System/360 Text Processor HYPHENATION/360—Application Description 60

HYPHENATION/360 provides division of words for text processing applications in which the addition of word syllables to a line to meet justification requirements is preferable to forcing the line to end with a complete word. This hyphenation capability is provided in the form of a module that can be linked with a user's System/360 text-processing program or the COMPOSITION/360 module of the IBM System/360 Text Processor.

Through program linkage, HYPHENATION/360 accepts a word from the user's program and determines the division points. The word, with the division points indicated, is returned to the user's program, where the portion to be retained on the line can be selected on the basis of the user's graphic requirements.

This publication contains general descriptions of the application and program; a general systems chart; and programming system, minimum machine, and core and disk requirements.

For detailed information the reader is referred to the *Program Description Manual*, Order Number GH20-0525. (22 pages)

GE20-0306 IBM 1287 Input Conversion Program—Application Description 60

The IBM Input Conversion Program translates cut-form document information from the IBM 1287 Optical Reader into computer-processable data. The program is designed to enable a user to utilize the IBM 1287 Optical Reader in implementing input conversion in an efficient and economical manner without the need of additional programming. The input conversion process is an essential link between the information coming from the multitudes of data sources and its utilization in an integrated data processing system.

The ability of the IBM 1287 to accept numerical data (plus some special symbols) from documents provides an economical system solution for the expeditious and accurate data collection required by any advanced data processing system. (22 pages)

GE20-0324 IBM System/360 Text Processor, EDIT/360 Application Description Manual 60

The need for an accurate and orderly flow of copy is of prime importance in today's printing and publishing organization. Not only must copy be transformed quickly from the original author's document into the justified format of the final printed page, but it must be done accurately. No matter how fast composition is, when the final copy is erroneous and has to be reset, time and money are wasted. The IBM System/360 Text Processor is designed to provide a means of assuring accurate copy produced at computer speeds.

The IBM System/360 Text Processor, EDIT/360, enables the user to produce error-free copy, completely justified and hyphenated in the format required by the user's composition devices. In addition to entering new copy into the system, the user

can make corrections and/or changes to copy previously entered. The EDIT/360 Program also provides several different formats of justified output, so that the user may view copy entered into the system.

The flexible design of the IBM System/360 Text Processor under control of the Disk Operating System permits the addition of user-written programs running in a simultaneous environment. The open-ended design of the System/360 permits the attachment of input and output devices and/or increased core capacity as the needs of the user expand.

Since I/O independence is inherent in the design, the IBM System/360 Text Processor communicates only with the attached 2311 Disk Storage Drive. Input material is accepted from the disk file, processed, and written back onto another file. This enables the user to output the data on the device of his choice, while at no time impairing the capabilities of the Text Processor programs. (52 pages)

GH20-8172 Bibliography of Data Processing Techniques 00

This bibliography and associated classification system provide a means to identify selected IBM publications which, either wholly or in part, document data processing techniques information. The listing of any given publication in this bibliography, however, does not preclude its appearance in other reference bibliographies such as the Systems Reference Library.

Part I of this bibliography lists publications within major subject classification. Note that a publication may appear in more than one classification. Part II contains abstracts of the publications in form-number sequence. (12 pages)

GH19-0014 IBM System/360 Resource Allocation (Real/360) for Project Control System/360 Application Description Manual 65

Program Number: 5736-XP2

REAL/360 complements the Project Control System/360 (PCS). Present conventional PERT/CPM-type scheduling programs provide project schedulers or managers with an efficient tool for planning, evaluating, scheduling, and controlling the activities to be managed; unlimited availability of resources, however, is assumed.

REAL/360 enables users to define project schedules, based on PCS results, while at the same time taking various resource limitations and time constraints into account. The reader should be knowledgeable in PERT/CPM techniques and be familiar with Project Control System/360 (360A-CP-06X, Version 2). (24 pages)

SH19-0026 IBM System/360 Resource Allocation (Real/360) for Project Control System/360 Program Description and Operations Manual 65

Program Number: 5736-XP2

REAL/360 performs the resource allocation in a project control system. It enables users to define

project schedules, based on the results of the Project Control System/360 (PCS), while at the same time taking various resource limitations and time constraints into account. This manual provides information necessary for understanding the functions of REAL/360 and for preparing and operating the system.

The reader should be familiar with the following publications:

Project Control System/360 Application Description Manual, Order Number GH20-0222

Project Control System/360 Program Description and Operations Manual, Order Number GH20-0076

IBM System/360 Resource allocation (REAL/360) for Project, Control System/360 Application Description Manual, Order Number GH19-0014. (104 pages)

GH20-0126 Advanced Life Information System—Application Description 60

Program Number: 360A-IL-09X

This system represents a new insurance information systems approach to the maintenance, processing, and servicing of individual life insurance contracts. It provides for immediate direct access inquiry and a base for a teleprocessing communications network.

The system uses a modular programming technique to process all scheduled and nonscheduled transactions, to provide figures for annual and interim statement purposes, to update policies with cash values, dividends, and other forms of participation, and to update policies with renewable term premiums on or just before anniversary. Internal and remote interrupt capabilities provide policy status on loan, surrenders, and mode premium values.

Basically, the information contained in this manual includes a general description of the system, insurance statements describing the approach, and a discussion of the policy master record. The manual is intended to define for the reader the amount of information needed to establish the system and to serve as a guide for his early planning. (64 pages)

GH20-0136 Mathematical Programming System/360—Application Description 60

MPS/360 is an open-ended mathematical programming system. This manual is an overview of the capabilities of MPS/360 (360A-CO-14X), MARVEL (360A-CO-15X), and the MPS Report Generator (360A-CO-20X). MARVEL and the MPS Report Generator operate under the control of MPS/360. The detailed capabilities of each functional component are described in the associated User's Manual.

Use of MPS/360 might involve building a mathematical model, finding an optimal solution, determining the effect of changing key data on the optimal solution, computing alternate solutions by systematically varying cost or requirement data, and preparing a management report. Application areas include material allocation, blending of ingredients, production or refinery scheduling, distribution and shipping, machine loading, waste reduction, and many other areas. (36 pages)

GH20-0149 System/360 Online 60
Teller Program and Mortgage Loan
Background Capability—Application
Description

Program Number: 360A-FB-16X

This program furnishes System/360 programming support for 1060 systems and minimizes expenses in installing and maintaining teller terminal complexes. The Application Description gives an overview of the program, lists its advantages, discusses applications- and machine-oriented concepts, presents control and audit procedures, and contains other standard sections, plus a glossary of terms. (18 pages)

GH20-0166 System/360 Scientific 60
Subroutine Package Version III—
Application Description

Program Number: 360A-CM-03X

The Scientific Subroutine Package (SSP) is a collection of over 250 FORTRAN subroutines divided, for the sake of presentation, into two groups: statistics and mathematics. Over 200 subroutines are presented in both single- and double-precision mode. SSP is a collection of input/output free computational building blocks that can be combined with a user's input, output, or computational routines to meet his needs. The package can be applied to the solution of many problems in industry, science, and engineering.

Version 3 of the Scientific Subroutine Package for System/360 incorporates and extends the capabilities of the original SSP/360. This version provides over 40 new mathematical and statistical subroutines, 24 of which are in both single- and double-precision FORTRAN. Typical of the new capabilities is the use of the QR iteration for obtaining eigenvalues of a matrix, and the nonparametric test of Kolmogorov-Smirnov.

The application description presents the purpose and objectives of the program, a list of subroutines, machine configuration, programming systems, precision, and a list of reference material. (20 pages)

GH20-0173 System/360 Wholesale 60
IMPACT Program Library Version
2—Application Description

Program Number: 360A-DW-05X

This manual describes use of the System/360 Wholesale IMPACT Program Library to implement the IMPACT system of scientific inventory management. The Wholesale IMPACT system provides the means of deciding when to order and how much to order for items in inventory so as to minimize the total cost of inventory, purchasing and receiving, and lost discounts for any specified level of service. This is accomplished by use of probability science in combination with an IBM System/360. (16 pages)

GH20-0181 System/360 APT 60
Numerical Control Processor
Versions 3 and 4—Application
Description

Program Number: 360A-CN-10X

The IBM System/360 APT uses a symbolic language to simplify the preparation of instructions

for numerically controlled machine tools. The APT processor prepares intermediate data for a user-written postprocessor program. (84 pages)

GH20-0186 General Purpose 60
Simulation System/360—Applica-
tion Description

This manual discusses the role of GPSS in system simulation, briefly describes the operation of the GPSS program, and points out its application scope. A final section describes the new entities, block types, expanded features, and system requirements of GPSS/360. (18 pages)

GH20-0194 System/360 Data 60
Conversion Utilities—Application
Description

This publication describes the general capabilities of IBM System/360 Data Conversion Programs and, through examples, illustrates their use.

The IBM System/360 Data Conversion Programs provide an effective and flexible capability for converting current IBM system data files to System/360 data sets. Designed as general purpose utility programs utilizing control cards, the programs will accept data sets from current IBM systems tape or DASD devices and write these data sets in the proper formats on System/360 tape or DASD devices. The programs have data transformation capability that allows maximum flexibility in reystemizing data sets for System/360. (49 pages)

GH20-0197 System/360 Bill of 60
Material Processor—Application
Description

Program Number: 360-ME-06X

The IBM System/360 Bill of Material Processor is an implementation package used to create and maintain a central information system for a manufacturing organization. The package will contain (1) generalized programs to organize and maintain part number (inventory, etc.), product structure, manufacturing routing, and work center data on direct access files, and (2) logic diagrams explaining the retrieval and use of the information in manufacturing applications.

This manual contains a general description of the application, the machine configuration, general systems charts, and a discussion of input/output files. A section that contrasts this package to the IBM 1440-1311 Bill of Material Processor (1440-ME-02X) is provided for 1440 users who may wish to upgrade their present system to a System/360. (38 pages)

GH20-0199 Flowchart—Application 60
Description

Program Number: 360A-SE-22X

The IBM System/360 Flowchart is a System/360 program designed to produce program flowcharts.

This documentation aid operates under the IBM Disk Operating System (DOS) and is intended to minimize the planning and effort required to produce and maintain program documentation.

It enables the user to:

1. Produce clear, standardized, easily reproduced computer-generated flowcharts.
2. Facilitate program development by keeping flowcharts continually up to date.
3. Standardize flowcharting techniques.

This publication describes the purposes and objectives of the IBM System/360 Flowchart and explains its uses. It contains a general description of the application, a discussion of the input language, an explanation of System/360 Flowchart processing, a detailed description of the statements, and miscellaneous application information.

For detailed information, the user is referred to the User's Manual. (25 pages)

GH20-0202 Student Scheduling 60
System/360—Application
Description

Student Scheduling System/360 is a class section assignment package for scheduling students in secondary schools, vocational schools, and junior colleges. After a school has created a master schedule of course offerings, the system processes student requests to create student schedules and class lists.

This scheduling package includes two auxiliary programs. A Tally program and a Conflict Matrix program furnish the school administrator with data useful to master schedule creation. The Tally run lists the total number of students requesting each course, and the Conflict Matrix points out potential scheduling conflicts.

The new package contains improvements over many similar programs. Greater flexibility is achieved by inclusion of many new user options, such as better study hall control, common-course scheduling, an expanded prun edit, and alternate course substitution. Parameters controlling number of periods per day, number of courses offered, sections per course, and total number of sections have been significantly enlarged. Features of the new IBM System/360 are also utilized to increase overall program effectiveness. (27 pages)

GH20-0205 System/360 Scientific 60
Subroutine Package Version III—
Programmer's Manual

Program Number: 360A-CM-03X

The Scientific Subroutine Package (SSP) is a collection of over 250 FORTRAN subroutines divided, for the sake of presentation, into two groups: statistics and mathematics. Also, over 200 subroutines are presented in both single- and double-precision mode. SSP is a collection of input/output-free computational building blocks that can be combined with a user's input, output, or computational routines to meet his needs. The package can be applied to the solution of many problems in industry, science, and engineering.

Version 3 of the Scientific Subroutine Package for System/360 incorporates and extends the capabilities of the original SSP/360. This version provides over 40 new mathematical and statistical subroutines, 24 of which are in both single- and double-precision FORTRAN. Examples of the new capabilities are the use of the QR iteration for obtaining eigenvalues of a matrix, and the non-parametric test of Kolmogorov-Smirnov.

This manual contains sufficient information to permit the reader to understand and use all of the subroutines of the Scientific Subroutine Package. (460 pages)

GH20-0210 Project Management 60
System for IBM System/360—
Application Description

PMS/360 is a highly modular set of computer program routines, each performing one function common to many management applications. It is open-ended—that is, the number of functions under PMS/360 can be expanded and added to. It is versatile—that is, the user can control program logic without resorting to reprogramming. Output reports can be defined with a single set of procedural statements and can be revised with every computer run if required. The computer code itself is written in a way that simplifies modification, if this ever becomes necessary. At present, PMS/360 contains the following three modules: a Network Processor, a Cost Processor, and a versatile Report Processor. In suitable combinations these processors will accomplish the data processing required in critical path analysis, PERT, and PERT Cost. (29 pages)

GH20-0217 System/360 COBOL 60
Edit on the 1401 Program
Reference Manual

Program Number: 1401-SE-13X

This program is of benefit to System/360 COBOL users in detecting syntactical errors in System/360 COBOL program statements before compilation of the System/360.

The program reference manual contains complete data on the application description, programming information, and operating instructions. Systems information is not presented in detail. (22 pages)

GH20-0220 Student Scheduling 60
System/360 The Tally and Conflict
Matrix Programs—User's Manual

Program Number: 360A-US-06X

Use of the Tally and Conflict Matrix programs of Student Scheduling System/360 is facilitated by this combined programmer's and operator's manual. These two programs furnish the school administrator the data needed to create the best possible master schedule of course and section offerings, prior to use of the Scheduler Program.

The Tally program accumulates the number of students requesting each course, by sex and by grade. These counts are used to determine how many sections of a given course are required.

Those courses shown to require one- or two-section offerings are entered into the Conflict Matrix program, which is then used to point out potential scheduling conflicts.

The programmer's section of this manual contains program systems charts, general program description, I/O description, program modification aids, sample problem, etc. The operator's section contains program setup sheet, console operator's instructions, message list, storage maps, and restart procedures. (22 pages)

GH20-0222 System/360 Project 60
Control System Version 2—
Application Description

Program Number: 360A-CP-06X

This manual presents a brief description of a project control system, and discusses the design, features, and input/output characteristics of a computer program developed to serve as the data processing element of such a system. Although the IBM System/360 Project Control System is designed primarily for those areas of government and industry concerned with construction, repair, or maintenance, its features are such that it can meet the critical path requirements of a broad range of users, regardless of industry. (24 pages)

GH20-0232 System/360 Data 60
Conversion Utility I Programmer's
Manual

Program Number: 360A-SE-15X

This program is useful in converting IBM 1620/1401/1440/1460/1410/7010 card, tape, and DASD data files to System/360 tape or DASD data sets.

The Programmer's Manual presents a general and detailed description of the program and its operation under the IBM System/360 Basic Operating System (8K disk). In addition, the individual modules, standard program interfaces, and incorporation of user modules are discussed.

The reader should be familiar with *IBM System/360 Data Conversion Utility I—Application Description*, Order Number GH20-0194, *IBM Basic Operating System/360 Assembler with Input/Output Macros (8K Disk)*, Order Number GC24-3361, and *IBM Basic Operating System/360 Programmer's Guide*, Order Number GC24-3372. (86 pages)

GH20-0233 System/360 Data 60
Conversion Utility I Operator's
Manual

Program Number: 360A-SE-15X

This program is useful in converting IBM 1620/1401/1440/1460/1410/7010 card, tape, and DASD data files to System/360 tape or DASD data sets.

The Operator's Manual presents a program setup sheet, console operating instructions, message list, storage maps and restart procedures.

The reader should be familiar with *System/360 Data Conversion Utilities—Application Description*, Order Number GH20-0194, *IBM System/360 Data Conversion Utility I—Programmer's Manual*, Order Number GH20-0232, and *IBM Basic Operating System/360 Operating Guide*, Order Number GC24-3450. (32 pages)

GH20-0239 Student Scheduling 60
System/360, The Scheduler Program
User's Manual

Program Number: 360A-US-07X

Student Scheduling System/360 is a class section assignment program for scheduling students in secondary schools, vocational schools, and junior colleges. After a school has created a master schedule of course offerings, the system processes student requests to create student schedules and class lists.

This manual contains a detailed explanation of the Scheduler program within the scheduling application framework, with special emphasis on input data and output reports. It also includes an "Operator's Section," which describes operational setup and running procedures. (64 pages)

GH20-0240 System/360 Continuous 60
System Modeling Program—Application
Description

Program Number: 360A-CX-16X

This is an IBM System/360 program for the simulation of continuous systems. It provides an application-oriented input language that accepts problems expressed in the form of either an analog block diagram or a system of ordinary differential equations. Data input and output are facilitated by means of application-oriented control statements.

This manual contains a general description of the application, the machine configuration, a general systems chart, and a sample problem. (32 pages)

GH20-0242 Synchronous Transmit 60
Receive Access Method for OS/360
Application Description

This manual describes the macro-instruction support which enables a System/360 with OS/360 to communicate with STR-type terminal devices. The level of support is discussed, and the language is briefly described. (12 pages)

GH20-0243 Synchronous Transmit 60
Receive Access Method for DOS/360
Application Description

This manual describes the macro-instruction support which enables a System/360 with DOS/360 to communicate with STR-type terminal devices. The level of support is discussed, and the language is briefly described. (7 pages)

GH20-0244 Communications Control 60
Application Program
Programmer's Manual

Program Number: 360A-SC-01X

This manual is intended to supply an overall understanding of the CCAP system concepts. It contains sufficient information to allow a systems programmer to plan and design a CCAP installation. Information necessary for implementing any modifications prior to installation is contained in detail in the System Manual supplied with delivery of the system from the Program Information Department. (52 pages)

GH20-0246 System/360 Bill of 60
Material Processor Version 2—
Programmer's Manual

Program Number: 360A-ME-06X

The IBM System/360 Bill of Material Processor is an implementation package used to create and maintain the central data files for a manufacturing organization.

This manual includes (1) a brief discussion of system definition, (2) a checklist of things to be done before modifying the file organization and maintenance programs or preparing retrieval programs, (3) descriptions of all I/O files, (4) explanation and operating instructions for the sample problem, (5) descriptions of all the file organization and maintenance programs and instructions for their modification, and (6) descriptions and logic diagrams for selected user retrieval programs. (400 pages)

GH20-0254 System/360 Bill of 60
Material Processor Version 2—
Operator's Manual

Program Number: 360A-ME-06X

The IBM System/360 Bill of Material Processor is an implementation package used to create and maintain the central data files for a manufacturing organization.

This operator's manual for the file organization and maintenance programs contains detailed operating information for:

1. Master File Creation and Maintenance Modules
2. Chain File Creation and Maintenance Modules
3. Bill of Material Processor Input/Output Modules to be used with user-prepared retrieval programs
4. File reorganization modules
5. A set of four specialized Bill of Material Processor utility programs

In addition there are specific operating procedures for IBM Basic Operating System/360 control programs and the IBM Disk Operating System/360 control programs as they apply to the Bill of Material Processor. (96 pages)

GH20-0255 System/360 Wholesale 60
IMPACT Program Library Program
Description Manual

Program Numbers:

360A-DW-05X, Version 2
360V-DW-06X

This program library provides a distributor with the information necessary to determine when and how much to order, thus minimizing the total cost of carrying inventory, purchasing and receiving, freight charges, and lost discounts for any specified level of service. The program library uses probability science in combination with an IBM System/360.

The IMPACT programs are grouped into two categories: initializing programs, and operating programs. Five programs are provided for initializing purposes: (1) Edit Run, (2) Mean Absolute Deviation and Forecast Model Run, (3) Order Quantity and Order Model Run, (4) Safety Stock and Safety Factor Run, and (5) Report Generator Run. Three programs are provided for operating purposes: (1) Service Point and Variable Interval Allocation Run, (2) Fixed Interval Allocation Run, and (3) Allocation Print Run. An extensive group of macroinstructions is included for incorporation in user-written programs. The Wholesale IMPACT program Library for the Model 20 (360V-DW-06X) is a subset of the System/360 Library (360A-DW-05X).

This manual contains a general description of the overall system and a detailed description of each program and macroinstruction. (184 pages)

GH20-0256 System/360 Wholesale 60
IMPACT Program Library Operations
Manual

Program Numbers:

360A-DW-05X, Version 2
360V-DW-06X

This program library provides a distributor with the information necessary to determine when and how much to order, thus minimizing the total cost of carrying inventory, purchasing and receiving, freight charges, and lost discounts for any specified level of service. The program library uses probability science in combination with an IBM System/360 Data Processing System.

The IMPACT programs are grouped into two categories: initializing and operating programs. Five programs are provided for initializing purposes: (1) Edit Run, (2) Mean Absolute Deviation and Forecast Model Run, (3) Order Quantity and Order Model Run, (4) Safety Stock and Safety Factor Run, and (5) Report Generator Run. Three programs are provided for operating purposes: (1) Service Point and Variable Interval Allocation Run, (2) Fixed Interval Allocation Run, and (3) Allocation Print Run.

The Model 20 Program Library is a subset of the System/360 Wholesale IMPACT Program Library.

This manual contains a general description of the overall system and a detailed description of each program. (72 pages)

GH20-0262 System/360 Demand 60
Deposit Accounting—Operator's
Manual

Program Number: 360A-FB-15X

This manual contains operating instructions for the runs that make up the System/360 Demand Deposit Accounting application program. It includes instructions for preparation of all I/O units, and, for each program, a program setup sheet, operating instructions, operator message list, and core map. (124 pages)

GH20-0263 System/360 Demand 60
Deposit Accounting—Programmer's
Manual

Program Number: 360A-FB-15X

This program is adaptable by commercial banks to accomplish demand deposit accounting in either a single or multi-bank environment. The program provides for conversion of IBM 1440 series disk and tape balance and name/address records. Also included are programs to collect and display historical profit and loss information for selected accounts or groups of accounts.

For each program, this manual presents a program abstract, program systems chart, and general description. Where applicable, some program modification aids are included.

The input/output section includes a summary for all files by type (card, disk, tape, printer, and MICR) and a visual record layout and description of file functions. (220 pages)

GH20-0283 Property and Liability 60
Information System Application
Description

The power and capacity of the IBM System/360 make possible the use of powerful new techniques in insurance data processing. The Property and Liability Information System is designed to implement these techniques. The system represents a new insurance information systems approach to the maintenance and processing of every insurance contract in a property and liability company. It provides for immediate direct access inquiry and a base for a teleprocessing communications network.

The system uses a modular programming technique to process the following transactions for all lines of insurance: new business, renewals, endorsements—money and nonmoney, cancellations, direct billing, premium collections, claims arising, claims updating, and status inquiries. In addition, provision is made to update and maintain an agency's production record. Programs written in a modular fashion also permit ease of understanding, maintenance, and modification, thus permitting each user to modify the system to his own specific needs.

The heart of this new system is the detailed policy master file stored on the IBM 2321 Data Cell Drive. Since the file will be updated daily, every record will be as current as the last transaction processed. For homeowners and private passenger automobile, the system provides rating modules for new business, renewals, endorsements, and cancellations, as well as the maintenance of the policy record.

Basically, the information contained in this manual includes a general description of the system, including a discussion of the transactions and the master records. The manual is intended to define for the reader the amount of information needed to establish the system and to serve as a guide for his early planning. (134 pages)

GH20-0285 System/360 Data Conversion Utility III, Version 2 Programmer's Manual 60

Program Number: 360A-SE-26X

These macros will be helpful in converting IBM 705/1401/1410/1440/1460/1620/7010/7040/7044/7070/7074/7080/7090/7094 card or tape data files to System/360 tape or DASD data sets.

This manual presents a general and detailed description of the program and its operation under the IBM System/360 Tape Operating System and the IBM System/360 Disk Operating System. In addition, the macro capabilities, standard program interfaces, and incorporation of user instructions are discussed.

The reader should be familiar with the corresponding Application Description, Order Number GH20-0194, and Operator's Manual, Order Number GH20-0286, and with those IBM System/360 manuals listed in the Application Directory. (93 pages)

GH20-0286 System/360 Data Conversion Utility III, Version 2 Operator's Manual 60

This program will be useful in converting IBM 705/1401/1410/1440/1460/1620/7010/7040/7044/7070/7074/7080/7090/7094 card and tape data files to System/360 tape or DASD data sets.

This manual presents operating procedures, a message list, restart procedures, and a program set-up sheet.

The reader should be familiar with the corresponding Application Description, Order Number GH20-0194 and Programmer's Manual, Order Number GH20-0285, and with *IBM System/360 Tape Operating System, Operating Guide*, Order Number GC24-5021, or *IBM System/360 Disk Operating System, Operating Guide*, Order Number GC24-5022. (17 pages)

GH20-0290 Mathematical Programming System/360 Version 2, Control Language User's Manual 60

Program Number: 360A-CO-14X

This manual is one of a series of manuals which describe the use of the IBM Mathematical Programming System/360 (MPS/360). It assumes that the user is familiar with the *Application Description*, Order Number GH20-0136 and *IBM Operating System/360 Job Control Language*, Order Number GC28-6539. This manual is a prerequisite of *MPS/360 Linear and Separable Programming User's Manual*, Order Number GH20-0476 and the *MPS/360 MARVEL Manual*, Order Number GH20-0505.

This manual describes the organization of the components of MPS/360 and their interface with Operating System/360 (OS/360). It also describes in detail the control language used to communicate a solution strategy for solving a mathematical programming problem to MPS/360, and the OS/360 job control language statements necessary to execute MPS/360. (48 pages)

GH20-0293 System/360 Flowchart User's Manual 60

Program Number: 360A-SE-22X

The IBM System/360 Flowchart is a System/360 program designed to produce program flowcharts. This documentation aid operates under the IBM Disk Operating System (DOS) and is intended to minimize the planning and effort required to produce and maintain program documentation.

It enables the user to:

1. Produce clear, standardized, easily reproduced computer-generated flowcharts.
2. Keep flowcharts continually up to date.
3. Standardize flowcharting techniques.

This reference publication contains the specifications and detailed instructions for using the System/360 Flowchart program. The only prerequisite for reading it is a basic understanding of flowcharting. (56 pages)

GH20-0294 System/360 Flowchart Operator's Manual 60

Program Number: 360A-SE-22X

The IBM System/360 Flowchart is a System/360 program designed to produce program flowcharts. This documentation aid operates under the IBM Disk Operating System (DOS) and is intended to minimize the planning and effort required to produce and maintain program documentation.

It gives the user the ability to:

1. Produce clear, standardized, easily reproduced computer-generated flowcharts.
2. Keep flowcharts up to date continually.
3. Standardize flowcharting techniques.

This reference publication gives the specifications and detailed information for operating the System/360 Flowchart program. It contains the console operating instructions, job control card deck key, job control card details, halt and message list, a file and storage map, and restart procedures.

A knowledge of DOS operating procedures, including the use of job control card, is a prerequisite for reading and using this manual.

For more detailed information about the System/360 Flowchart input language, refer to the User's Manual. (20 pages)

GH20-0297 System/360 Administrative Terminal System—OS (ATS/OS) Application Description Manual 60

Program Number: 360A-CX-19X

This system consists of control and functional programs that permit many different text-processing and data-handling activities to be carried on simultaneously through different typewriter terminals attached to an IBM System/360. Written to operate

under OS/360, the Administrative Terminal System runs in a multiprogramming environment. It will run concurrently with and independently of other tasks in other partitions/regions.

This publication contains a general discussion of the features of the program, an indication of some of the areas in which it may be applied, and the machine configuration required. Three appendices are included dealing with data formats, core storage estimates, and communication line requirements. (28 pages)

GH20-0302 Shared Hospital Accounting System (SHAS) Application Description 60

Program Number: 360A-UH-11X

The Shared Hospital Accounting System (SHAS), developed by IBM, provides extensive accounting services to groups of hospitals sharing central System/360 computer facilities. By means of a flexible system of programs and options, each participating hospital retains its own individuality in terms of access to records as well as types and formats of files set up and reports generated.

Managed by an executive program, the system records and processes data related to inpatient and outpatient billing, accounts receivable, and general ledger, and is designed to facilitate automatic preparation of Medicare and other insurance billing forms. Communication with the central facility is effected through teleprocessing terminals located at each hospital in the group.

This publication describes the objectives and features of the IBM Shared Hospital Accounting System and is designed to give the reader an overall knowledge of the system without reference to program detail. (112 pages)

GH20-0304 General Purpose Simulation System/360 Introduction—User's Manual 60

This publication provides a basic introduction to the use of the General Purpose Simulation System/360 (GPSS/360). It is written for those individuals who have no previous simulation experience.

Examples are given throughout the manual to emphasize the basic features of the GPSS/360 program. A complete and detailed description of all the GPSS/360 features may be found in the *General Purpose Simulation System/360 User's Manual*, Order Number GH20-0326. Readers are advised to obtain a copy of the User's Manual when they begin to write more sophisticated models.

The information presented in this manual should enable most readers to apply the program intelligently within a short period of time. (88 pages)

GH20-0305 System/360 Online Teller Program and Mortgage Loan Background Capability Programmer's Manual 60

Program Number: 360A-FB-16X

This program furnishes System/360 programming support for 1060 systems and minimizes expenses

in installing and maintaining teller terminal complexes. The Programmer's Manual presents the program logic and data definitions for the program. It enables a user to plan modifications to the program to suit his own requirements. (188 pages)

GH20-0309 System/360 APT Numerical Control Processor Version 4—Part Programming Manual 60

Program Number: 360A-CN-10X

This program has been developed to span the gap between the engineering drawing and the machine tool control system.

This manual describes APT (Automatic Programmed Tool), a programming system that uses an English-like language to describe a part shown as an engineering drawing. The statements are key-punched into cards, converted by the APT processor into an intermediate format, and then converted to instructions that can be read by the machine tool controller. (152 pages)

GH20-0311 General Purpose Simulation 60 Operating System/360—Operator's Manual

Program Number: 360A-CS-17X

This publication contains information that will enable the user to link-edit and incorporate the GPSS/360 program into a system for subsequent execution under the control of OS/360. Detailed examples are given for editing the GPSS/360 program into a private JOBLIB or the OS/360 SYS. LINKLIB; several other examples illustrate the OS/360 JOL cards required to execute models that use various features provided by GPSS/360.

This Operator's Manual describes and illustrates a method (REALLOCATION) whereby the user can reallocate the quantity of GPSS/360 entities and effectively use all available core on a given machine. The various data sets required by GPSS/360 are also listed and described. (37 pages)

GH20-0313 System/360 Data Conversion Utility II, Version 3 (Sequential, Direct Access)—Programmer's Manual 60

Program Number: 360A-SE-20X

This program will be useful in converting IBM 705/1410/7010/7040/7044/7070/7074/7080/7090/7094 card, tape, and DASD data files to System/360 tape or DASD data sets.

This manual presents a general and detailed description of the program and its operation under the IBM Operating System/360. In addition, the individual modules, standard program interfaces, and incorporation of user coding are discussed. (122 pages)

GH20-0314 System/360 Data Conversion Utility II, Version 3 (Direct Access Indexed Sequential)—Operator's Manual 60

Program Number: 360A-SE-20X

This program will be useful in converting IBM 705/1410/7010/7040/7044/7070/7074/7080/7090/7094 card, tape, and DASD data files to System/360 tape or DASD data sets.

This manual presents a program setup sheet, console operating instructions, and a message list. (14 pages)

GH20-0315 IBM System/360 Document Processing System—Application Description 60

The System/360 Document Processing System operates under the control of Operating System/360, processing narrative and bibliographic data into a set of interrelated data sets. These data sets can then be searched for Boolean combinations of keywords. Various elements of the data sets can be manipulated by a set of special utilities to produce various forms of indexes.

Without limiting the system to a specific application, because no such limit exists, this manual surveys the operational concepts and capabilities of System/360 Document Processing. Routines within the system are written in the OS/360 Assembler Language and require no further coding on the part of the system user. (28 pages)

GH20-0318 Customer Information Control System DOS-Entry (CICS/DOSE) DOS-Standard (CICS/DOSS) OS-Standard (CICS/OS) With Language/Terminal (L/T) Feature Application Description 65

Program Numbers:

DOS-Entry 5736-XX6

DOS-Standard 5736-XX7

OS-Standard 5736-U11

The IBM Customer Information Control System (CICS) is a highly responsive, transaction oriented, multiapplication data base/data communication interface between a System/360 operating system and user-written application processing programs. In addition to the functions required for inquiry and conversational data entry, this open-ended, table-controlled, event-driven system provides many of the facilities necessary for standard terminal applications such as message switching, broadcasting, data collection, and order distribution.

The Customer Information Control System (CICS), as its name implies, was designed for the highly demanding Customer Information System environment; however, it has been found to be applicable to most on-line real-time data base systems. (48 pages)

GH20-0319 System/360 Data Conversion and Label Processing Subroutines, Version 2 Program Reference Manual 60

Program Number: 360A-SE-23X

This manual contains a description of a set of subroutines that may be used in converting data files from current system formats to System/360 formats and vice versa. The subroutines available for processing current system data file formats are listed and described. Also, the use of the subroutines is shown by example. (63 pages)

GH20-0321 IBM System/360 Attached Support Processor System (ASP) Version 2 Console Operator's Manual 60

Program Number: 360A-CX-15X

The Attached Support Processor (ASP) system is a multiprocessor operating system that provides a compatible extension to Operating System/360 (OS/360). Designed primarily for the use of the customer with a large scientific system and a workload typically consisting of many jobs of short duration, ASP includes features to facilitate the use of the 709X Emulator and OS/360 integrated into the same operational environment.

This manual contains instructions that will permit the console operator to operate the ASP system. ASP console operation is identical in most respects to IBM System/360 operation. Therefore, to avoid repetition of documentation, the material in this manual has been prepared on the assumption that the operator is familiar with IBM System/360 operation. Details concerning System/360 operations are found in *IBM System/360 Operating Systems, Operator's Guide*, Order Number GC28-6540, and in its prerequisite and recommended publications. If the 709X Emulator is to be used, the ASP operator should also be familiar with IBM System/360 Conversion Aids, 709/7090/7094/7094II Emulator Program, Order Number GC28-6565. (120 pages)

GH20-0322 IBM System/360 Attached Support Processor System (ASP) Version 2 Application Programmer's Manual 60

Program Number: 360A-CX-15X

The Attached Support Processor (ASP) system is a multiprocessor operating system which provides a functional extension to Operating System/360 (OS/360). Designed primarily for the use of the customer with a large scientific system whose workload typically consists of many jobs of short duration, ASP includes features to facilitate the use of the 709X Emulator and OS/360 integrated into the same operational environment.

This manual contains detailed information concerning system concepts, programming considerations, control cards, deck setup, and output. OS/360 programming is the primary operating system used for ASP; therefore, to avoid repetition of documentation, the material in this manual has been prepared on the assumption that the programmer

is familiar with OS/360 programming. Details of OS/360 utilization are found in *IBM Operating System/360 Job Control Language*, Order Number GC28-6539, and in its prerequisite and recommended publications. (44 pages)

GH20-0323 IBM System/360 60
Attached Support Processor
System (ASP) Version 2
System Programmer's Manual

Program Number: 360A-CX-15X

The Attached Support Processor (ASP) system is a multiprocessor operating system which extends the functional capabilities of Operating System/360 (OS/360). Designed primarily for the use of the customer with a large scientific system whose workload typically consists of many jobs of short duration, ASP includes features to facilitate the use of the 709X Emulator and OS/360 integrated into the same operational environment.

This manual contains detailed information concerning the internal operations of the ASP system and includes a functional description, instructions for writing Dynamic Support Programs and for generating the system, and a description of modifications to OS/360 and 709X Emulator programs. (172 pages)

GH20-0325 System/360 Online 60
Teller Program and Mortgage
Loan Background Capability
Operator's Manual

Program Number: 360A-FB-16X

The Operator's Manual includes operating procedures for the Online Teller program as well as the Conversion, Reorganization, and Control Pack Setup programs. It also contains a discussion of testing aids. (36 pages)

GH20-0326 General Purpose 60
Simulation System/360—User's
Manual

This publication is an extension and amplification of the GPSS/360 Introductory User's Manual, Form H20-0304. It provides a detailed description and explanation of the component parts and operation of the GPSS/360 program. Examples illustrating the uses of GPSS/360 are given in appropriate sections of the manual. This manual should enable the reader to construct and simulate models using the full capabilities of GPSS/360. (244 pages)

GH20-0327 General Purpose 60
Simulation System/360, Disk
Operating System Operator's
Manual

Program Number: 360A-CS-19X

This publication contains information that will enable the user to link-edit and incorporate the GPSS/360 program into a system for subsequent execution under the control of DOS/360.

A method (REALLOCATION) whereby the user can reallocate the quantity of GPSS/360 entities and effectively use all available core on a given machine is described and illustrated. The various data sets required by GPSS/360 are also listed and described. (20 pages)

GH20-0329 IBM System/360 Product 60
Structure Retrieval Program—
Application Description

The IBM System/360 Product Structure Retrieval Program is an implementation package used to retrieve product structure records created and maintained by the System/360 Bill of Material Processor Program (360A-ME-06X). The package will contain (1) generalized programs to retrieve product structure records, (2) flexible user report formats, and (3) logic diagrams explaining the retrieval and use of the information in manufacturing applications.

This manual contains a general description of the application, the machine configuration, general systems charts, and a discussion of input/output files. (24 pages)

GH20-0331 System/360 APT 60
Numerical Control Processor,
Version 4 Operations Manual

Program Number: 360A-CN-10X

This manual provides suggested processor generation and maintenance techniques, program setup instructions, console operating instructions, halts and error messages, storage map, and restart procedures. (48 pages)

GH20-0344 Project Management 60
System/360 Version 2 Program
Description and Operations Manual

Program Number: 360A-CP-04X

This manual provides a detailed description of the three component parts of PMS/360; the Network Processor, the Cost Processor, and the Report Processor. It provides in detail the format of input required, the methods of calculation followed, and an explanation of the output generated by each processor. It also defines OS/360 Job Control cards required to run the three processors.

This manual will enable the user to perform critical path analysis as well as PERT and PERT/Cost analyses. (400 pages)

GH20-0346 Synchronous Transmit- 60
Receive Access Method for DOS/360
User's Manual

Program Number: 360A-SE-32X

This publication describes the Synchronous Transmit-Receive Access Method for DOS/360. The STR access method provides macro instructions and routines to support STR transmission under

program control. The macro instructions are described for the following functions:

1. Environment definition
2. Line control
3. Data transmission
4. Code conversion

In addition, the STR error messages are described and a macro instruction summary is given. Prerequisites are: a basic knowledge of System/360 machine concepts, a basic knowledge of DOS/360, and a knowledge of the principles of STR data transmission. (36 pages)

GH20-0347 Synchronous Transmit- 60
Receive Access Method for
DOS/360 Operator's Manual

Program Number: 360A-SE-32X

This publication describes the operator actions when using the Synchronous Transmit-Receive Access Method for DOS/360. Topics include establishing a data line, error messages, and maintenance. (8 pages)

GH20-0349 Synchronous Transmit- 60
Receive Access Method for
System/360 Operating System
User's Manual

Program Number: 360A-SE-33X

This publication describes the Synchronous Transmit-Receive Access Method for OS/360. The STR Access Method provides macro instructions and routines to support STR transmission under program control. The macro instructions are described for the following functions:

1. Environment definition
2. Line control
3. Data transmission
4. Buffer management
5. Code conversion

In addition, the STR error messages are described and a macro instruction summary is given. Prerequisites are: a basic knowledge of System/360 machine concepts, a basic knowledge of OS/360, and a knowledge of the principles of STR data transmission. (64 pages)

GH20-0350 Synchronous Transmit- 60
Receive Access Method for OS/360
Operator's Manual

Program Number: 360A-SE-33X

This publication describes the operator actions when using the Synchronous Transmit-Receive Access Method for OS/360. Topics include establishing a data line, error messages, and maintenance. (8 pages)

GH20-0352 1400 Autocoder to 60
COBOL Conversion Aid Program
Version 2 Application Description

Program Number: 360A-SE-19X

This document provides information about the 1400 Autocoder to COBOL Conversion Aid Program (ACCAP) and its resulting COBOL programs.

The information provided should enable the user to evaluate ACCAP for his installation before its use.

The manual contains a general description of ACCAP, a discussion of the overall program conversion process, and some testing experiences with the program. (28 pages)

GH20-0354 System/360 Remote 60
Access Computing System (RAX)
Version 4 Program Description Manual

Program Number: 360A-CX-17X

This publication provides the information necessary to use the IBM System/360 Remote Access Computing System (RAX). It contains a description of the system, which provides concurrent access to a System/360 Model 30, 40 or 50, for up to 63 communication terminals. This system provides for the compilation and execution of basic FORTRAN IV and Basic Assembler Language programs and the maintenance of program and data files in a library structure. (148 pages)

GH20-0355 System/360 Remote 60
Access Computing System (RAX)
Version 4 Operations Manual

Program Number: 360A-CX-17X

This publication provides the System/360 machine operator with detailed instructions for starting, running, and stopping the Remote Access Computing System (RAX). It includes machine requirements, description of online messages and their meanings, and restart procedures. This manual also includes the procedures required for system generation and library maintenance. (44 pages)

GH20-0367 System/360 Continuous 60
System Modeling Program User's
Manual

Program Number: 360A-CX-16X

This is an IBM System/360 program for the simulation of continuous systems. It provides an application-oriented input language that accepts problems expressed in the form of either an analog block diagram or a system of ordinary differential equations. Data input and output are facilitated by application-oriented control statements.

This manual contains a general description of the program, detailed programming information, and a description of the inputs and outputs. (68 pages)

GH20-0368 System/360 Continuous 60
System Modeling Program Operator's
Manual

Program Number: 360A-CX-16X

This is an IBM System/360 program for the simulation of continuous systems. It provides an application-oriented input language that accepts problems

expressed in the form of either an analog block diagram or a system of ordinary differential equations.

This manual contains information and procedures that will enable the user to incorporate the System/360 Continuous System Modeling Program into an Operating System/360 library; to include a procedure in the Operating System/360 procedure library (OS/360 SYS1. PROCLIB); and subsequently to execute System/360 CSMP under the control of, and using the services of, OS/360. (20 pages)

GH20-0369 System/360 Product 60
Structure Retrieval Program
Programmer's Manual

Program Number: 360A-ME-07X

The IBM System/360 retrieval package for the Bill of Material Processor Program provides the following types of retrieval:

1. Single-level explosion
2. Indented explosion
3. Summarized explosion
4. Single-level implosion
5. Indented implosion
6. Summarized implosion

This manual includes:

1. A brief discussion of system definition.
2. A checklist of things to be done before customizing retrieval programs.
3. Descriptions of all I/O files.
4. Explanation and operating instructions for the sample problem.
5. Descriptions of all retrieval programs and subroutines, plus instructions for their modification.
6. Descriptions and logic diagrams for three retrieval phases. (48 pages)

GH20-0370 System/360 Product 60
Structure Retrieval Program
Operator's Manual

Program Number: 360A-ME-07X

The IBM System/360 Bill of Material Processor Retrieval Programs constitute an implementation package that uses the assembly and where-used information from the processor files previously loaded on disk to produce reports for the user.

This manual for the retrieval programs contains detailed operating information for retrieval program system loading and retrieval job control. (16 pages)

GH20-0372 Mathematical Programming 60
System/360 Read Communications
Format (READCOMM)—Program
Reference Manual

Program Number: 360A-CO-14X

This manual provides the system user with the information necessary to use the Read Communications Format (READCOMM) feature of MPS/360. READCOMM is a subroutine that enables the user to augment MPS/360 with procedures written in the FORTRAN language.

This manual assumes that the user is familiar with the *MPS/360 Application Description*, Order Number GH20-0136, the *MPS/360 Control Language User's Manual*, Order Number GH20-0290, the *MPS/360 Linear Programming User's Manual*, Order Number GH20-0291, and the FORTRAN programming language. (48 pages)

GH20-0373 System/360 AUTOSPOT 60
Numerical Control Processor,
Version 2—Part Programming Manual

Program Number: 360A-CN-08X

This manual describes the AUTOSPOT language for users of numerically controlled machine tools. Included in this manual are definitions and examples of language elements. Also included are the interpretation of machining statements as output to the CLFILE and the description of this output file. (176 pages)

GH20-0374 System/360 AUTOSPOT 60
and AD-APT/AUTOSPOT Numerical
Control Processors, Version 2—
Operator's Manual

Program Numbers:

360A-CN-08X (AUTOSPOT)
360A-CN-09X (AD-APT/AUTOSPOT)

This manual provides suggested processor generation and maintenance techniques, program setup instructions, console operating instructions, halts and error messages, storage map, restart procedures, and disk storage map. (12 pages)

GH20-0375 System/360 AD-APT/ 60
AUTOSPOT Numerical Control
Processor, Version 2 Part
Programming Manual

Program Number: 360A-CN-09X

The IBM N/C 360 adaptation of APT for small computers (AD-APT) uses a symbolic language to simplify the preparation of instructions for numerically controlled machined tools. The AD-APT processor prepares intermediate data for a user-written postprocessor program.

This manual contains the definition and examples of the AD-APT symbolic language. (152 pages)

GH20-0376 Project Control 60
System/360 Version 2 Program
Description and Operations Manual

Program Number: 360A-CP-06X

The Project Control System serves as the data processing element of a system that helps management carry out its functions of planning and supervising projects, within a broader environment of

operations and procedures. Although designed primarily for those areas of government and industry concerned with construction, repair, or maintenance, the system will meet the critical path requirements of a broad range of users, irrespective of industry. It will process data from networks planned in either precedence-diagramming or arrow-diagramming methods. The system consists of a set of routines stored on disk. The sequence of processing and system outputs is controlled by the system control card, the type of input data to be processed, and the output report requests submitted at run time. Output reports include status listings, bar charts, and basic resource and cost summarization reports. Updating capability is provided for network restructuring as well as progress reporting for in-process work items. (130 pages)

GH20-0462 IBM System/360 60
AUTOSPOT Numerical Control
Processor—Application Description

Program Number: 360A-CN-08X

The purpose of this manual is to provide an introduction to the AUTOSPOT language for users of numerically controlled machine tools. Included in this manual are language structure and elements, and system configuration. (24 pages)

GH20-0463 IBM System/360 AD-APT/ 60
AUTOSPOT Numerical Control
Processor Application Description

Program Number: 360A-CN-09X

The IBM N/C 360 adaptation of APT for small computers (AD-APT) uses a symbolic language to simplify the preparation of instructions for numerically controlled machine tools. The AD-APT processor prepares intermediate data for a user-written postprocessor program. (44 pages)

GH20-0464 IBM System/360 60
Vehicle Scheduling Program
Application Description

This publication describes the general capabilities of the IBM System/360 Vehicle Scheduling Program and explains some of the many uses of this approach.

The Vehicle Scheduling Program determines the route that a group of vehicles must travel in order to meet certain commitments in the delivery of service or products to a collection of given destinations. The program tends to minimize some of the basic parameters, such as distance, time, and the number of vehicles, or achieves a satisfactory balance of these. The program analyzes a network representing the potential calling points and computes either actual or approximate distances between all points. A schedule is then produced with adherence to restrictions such as route-time, speed, vehicle capacity, and customer requirements. (32 pages)

GH20-0466 IBM System/360 Attached 60
Support Processor System (ASP)
Version 2—System Description

Program Number: 360A-CX-15X

The Attached Support Processor (ASP) system is a multiprocessor operating system that provides a compatible extension to Operating System/360 (OS/360). Designed primarily for the use of the customer with a large scientific system and a workload typically consisting of many jobs of short duration, ASP includes features to facilitate the use of the 709X Emulator and OS/360 integrated into the same operational environment.

An outgrowth of the 704X-709X Direct Couple Operating System (DCS), ASP incorporates the operational characteristics of this system, although it diverges from it in implementation. (40 pages)

GH20-0471 System/360 Inventory 60
Control Application Description

The IBM inventory control application consists of a group of integrated programs and techniques designed for the selection and implementation of order point inventory control where it applies in manufacturing organizations. The programs provide for:

1. Classification of inventory items for determining the type of control.
2. Calculation of economic order quantities on the basis of usage information or future requirements.
3. Computation of safety stock and order point.
4. Projection of demand on the basis of historical data.
5. Basic programs for transaction processing and report preparation.

This manual includes a general description of these programs, the machine configuration, general systems charts, sample reports, and a discussion of inventory control concepts applicable to the use of the programs. (68 pages)

GH20-0475 System/360 Automated 60
Chemistry Program (360 ACP) for the
1080 Data Acquisition System—
Application Description

Program Number: 360A-UH-12X

The 360 ACP, a Type II program within the Clinical and Administrative REcord system (CARE), is a System/360 program designed to operate under the System/360 Disk Operating System. The 360 ACP processes the punched card output of the IBM 1080 Data Acquisition System servicing continuous processing analyzer systems and one or more IBM 1084 Sampler Readers, all operating in a clinical laboratory environment. It matches specimen identification numbers with their raw data values, makes the necessary adjustments, and computes specimen concentrations. A quality control report is produced which summarizes the test runs, and each test result and specimen identification number is stored in disk memory. By a

user-provided program, the results are stored in the patient file. The 360 ACP requires 32K core storage, a 1052 Printer-Keyboard, a 2311 Disk Storage Drive, a printer, a card reader, and the floating-point and decimal arithmetic features.

The purpose of this manual is to provide a general description of the application, a description of the various program runs (including system flowchart), a description of the input/output files as related to the various runs, the machine configuration required, and a statement of the system advantages. (32 pages)

GH20-0476 Mathematical Programming 60
System/360 Linear and Separable
Programming—User's Manual

Program Number: 360A-CO-14X

This manual provides the system user with the information required to prepare input data and control cards and to interpret the system's output. It is a basic reference document for any user interested in the problems with which the system can help him. All procedures are fully explained in this manual. (224 pages)

GH20-0477 IBM System/360 Document 60
Processing System Program Description
and Operations Manual

Program Number: 360A-CX-12X

The System/360 Document Processing System is a set of programs designed to convert machine-readable document data into a set of searchable data sets, to search these data sets, and to produce various index listings. The system operates under the control of the System/360 Operating System.

This manual generally expresses the intent and content of an operations manual and a programming manual. Part 1 of the manual contains descriptive program information and specifications; Part 2 contains detailed operational instructions. A prerequisite to reading portions of this manual is a basic understanding of *IBM System/360 Operating System Job Control Language*, Order Number GC28-6539. (268 pages)

GH20-0479 System/360 Matrix 60
Language (MATLAN) Application
Description

MATLAN is a programming system that is designed to simplify handling of and computation with matrices. This publication describes the MATLAN language and its general capabilities.

Matrices may consist of real or complex, single- or double-precision numbers. Segmenting algorithms are used if the storage requirements of the matrices exceed available core size.

MATLAN is useful in many scientific and technical applications. It is of special interest in the aerospace industry, as well as in electrical and civil engineering, mathematical statistics, and econometrics. (20 pages)

GH20-0480 IBM Retail IMPACT Fashion System under Operating System/360 Program Description Manual 60

Program Number: 360A-DR-04X

The IBM Retail IMPACT Fashion System consists of programs and procedures designed to provide the retailer with timely and accurate information for fashion merchandising. The system provides reorder recommendations, return recommendations, and other action reports to assist the fashion merchandiser in responding to changes in the volatile fashion market.

This manual describes the concepts, characteristics, and implementation of the Fashion System. Operational controls, report interpretation, and complete file specifications are included. The programs are described conceptually and specifically. Input, output, and processing information is included along with program modification aids. This manual provides the information and guidance necessary for planning and installation of the system. (184 pages)

GH20-0481 Retail IMPACT Fashion System under Operating System/360—Operations Manual 60

Program Number: 360A-DR-04X

This manual provides instructions and guidance for operating the programs in the IBM Retail IMPACT Fashion System. The major components of the manual describe (1) preparatory information and procedures, (2) operations, and (3) retrieving the programs from the distribution tape, preparing the system, and running the sample problem. (44 pages)

GH20-0483 Advanced Life Information System Policy Master Record Code Book 60

The policy master record code book describes every section and trailer of the policy master record, each field in every section and trailer, and the codes and values applicable to each field. There is a table of contents at the beginning of the manual and one for each section and trailer. The table of contents at the beginning of the manual identifies only the location of sections and trailers. The table at the beginning of each section or trailer indicates the location of each field. (260 pages)

GH20-0487 System/360 Requirements Planning: Application Description Manual 60

*Program Numbers:
360A-MF-05X
5736-M13*

A manufacturing organization requires that all parts, both manufactured and purchased, be available to

meet production schedules demanded by finished product due dates, and that a sufficient quantity be available to satisfy demand. Manufacturing also must be able to adjust these requirements quickly to react suitably and in time to forecast any customer order changes. In addition, there is a need to maintain inventories at an optimum level so as not to incur the costs of obsolescence, unneeded warehouse space, unnecessary inventory, insurance, and purchase charges.

IBM System/360 Requirements Planning is designed to meet these needs. The system is capable of:

1. Determining net finished product requirements
2. Determining net component part requirements
3. Planning economic lot size or order quantities
4. Offsetting requirements by considering lead times
5. Maintaining and updating the requirements plan by processing changes to forecasts and orders (referred to as "requirements alterations")
6. Providing for review of planned orders at the end of each level; "interrupt" and adjustment of these planned orders, "reentry" (referred to as "conversational planning")
7. Providing for management review through detailed requirements reports and exception notices

A new Program Product, System/360 Requirements Planning (5736-M13), will be available concurrently with the availability of Program Product System/360 Capacity Planning—Finite Loading (5736-M12). This new Program Product will have the ability to create connection records used by Program Product System/360 Capacity Planning—Finite Loading (5736-M12). Those users not planning to use Program Product System/360 Capacity Planning—Finite Loading (5736-M12) may continue to order program 360A-MF-05X. In addition, those users planning to use Program Product 5736-M12 must order program 360A-MF-05X for the purpose of creating planned order information. (14 pages)

GH20-0489 Program for Optical System Design/II (POSD/II) Application Description Manual 60

*Program Numbers:
1130-EO-14X
360A-EO-15X
360A-EO-16X*

POSD/II consists of an interrelated set of programs providing a complete and flexible facility for the geometric analysis of image-forming optical systems, together with a means for automatically correcting such systems. Particular emphasis has been placed on creating an efficient man-machine relationship. The evaluation techniques available to the designer encompass both ray tracing and third- and fifth-order aberration analysis with ray-tracing speeds in the order of 1/10 second per ray surface. The program has the capacity to analyze systems containing prisms, toric surfaces, and diffraction gratings, in addition to the usual refracting or reflecting elements.

POSD/II is an extension of 1130 POSD (1130-EO-11X and 1130-EO-12X) with increased

operating speeds and additional program capabilities. Two new POSD/II programs are provided to operate under the IBM Problem Language ANalyzer (PLAN—PLAN operates as a submonitor providing simplified user modification of programs and design languages) program to support both the 1130 system and System/360. Additional utility features are incorporated to provide greater flexibility for the user. Significant improvements, such as provision for varying glasses, broaden the scope of the automatic design program.

POSD/II utilizes a free-form input format with operating procedures similar to 1130 POSD. (28 pages)

GH20-0490 Problem Language Analyzer (PLAN) Application Description Manual 60

*Program Numbers:
1130-CX-25X
360A-CX-26X
360A-CX-27X*

The IBM Problem Language Analyzer (PLAN) assists IBM and customer development of a variety of problem-solving computer applications. The value of a computer installation to technical, professional, and management personnel can be significantly increased, using PLAN. Programmers and system designers will also find that PLAN offers new tools for building interactive or fast-changing applications.

This is an introductory manual. The scope, advantages, features, and use of PLAN are presented in only enough detail to permit the reader to judge the impact of PLAN in his own environment. Additional detail will be found in formal documentation of the PLAN programs, and in program descriptions of IBM-written, PLAN-based applications. (36 pages)

GH20-0492 System/360 Decision Logic Translator Application Description Manual 60

Program Number: 360A-CX-32X

The Decision Logic Translator program accepts decision tables punched in cards in a prescribed format and translates the tables into a FORTRAN program. The FORTRAN source program is punched in cards or stored on disk or tape ready for compilation.

This manual describes the decision table language, the format of the input decision tables, features of the Decision Logic Translator, program output, and a sample problem. (28 pages)

GH20-0493 Mechanism Design System Kinematics—Application Description 60

A programmed system for the kinematic analysis of linkage mechanisms is made available to the mechanical engineer through the Mechanism Design System—Kinematics.

A wide variety of two- and three-dimensional linkage mechanisms can be analyzed with this FORTRAN-coded system. Program input provided by the engineer includes a list of the linkage elements and the connectivity of those elements,

metric data that gives size to the elements, and position and motion input data. For mechanisms that can be solved by the system, plotted and printed output is provided to aid the engineer in evaluating his design.

The primary functions of the program are to create a digital model of the linkage mechanism, solve for position and motion and display the calculated results. The model of the linkage can be stored on disk for later recall. The disk also stores intermediate results for data display after processing is complete. The use of a model facilitates modification of the linkage by simple and direct means.

This manual is divided into five sections. The introduction discusses the overall role of the 1130 Computing System and the System/360 in mechanism design and analysis. The next section discusses specific concepts of kinematic analysis, the programs that make up the system, and a sample problem. The third section gives machine and programming system requirements and estimated program timing. The fourth and fifth sections present glossary and references, respectively. (24 pages)

GH20-0494 Data Acquisition Multi-programming System (DAMPS), Version 2—Application Description 60

This manual describes an operating system for real-time scientific applications. The system will support a single real-time job containing multiple online applications in the foreground, while processing an offline application in the background. DAMPS, Version 2, supports the 32 levels of the Priority Interrupt special feature and the Store and Fetch Protection special feature, both of which are required for system operation. In addition to support for the usual peripheral devices, the system supports the IBM 1827 Data Control Unit for interfacing directly with scientific applications. (24 pages)

GH20-0495 Rigid Frame Selection Program (RFSP) Application Description 60

The Rigid Frame Selection Program (RFSP) provides direct optimal design procedures for rigid frame construction in steel, timber, or concrete. Two- and three-hinged frames may be analyzed and designed using the programs. Cost reduction can be realized in two ways—material inventory and design.

Procedures included in the program can be used to design members for different types of structures, using the results of analysis programs provided by the user.

The program operates under a problem-oriented language supported by the Problem Language Analyzer (PLAN), thus allowing the user to create his own input language, if he so prefers. (32 pages)

GH20-0496 MARVEL/360 Primer 60
Program Number: 360A-CO-15X

MARVEL is a language processor for the data preparation, matrix generation, output analysis,

and management report writing functions associated with the Mathematical Programming System/360 (360A-CO-14X). MARVEL was designed and implemented to provide powerful functional capabilities in this fast growing area of mathematical programming. In providing such a comprehensive language and processor capability, "trade-offs" were made that reduced execution speed.

MARVEL will provide maximum customer utility as an input/output system for the development of new linear programming applications, because this is an area where extended function is more significant than high performance. In a production environment where emphasis is on execution speed, MARVEL will be less suitable.

This MARVEL language primer is designed to acquaint the reader with the basic notation employed in MARVEL. Further, by constructing a sample program, it is hoped to introduce the potential user to a variety of MARVEL statements. The discussion of statements in the primer is limited to those features of each statement that are applicable to the specific problem presented. Therefore, the reader should consult the *MARVEL/360 Program Description Manual*, Order Number GH20-0505, where a comprehensive discussion of all MARVEL statements is provided. (60 pages)

GH20-0497 Property and Liability Information System (PALIS) Basic Program Description and System Manual 60

Program Number: 360A-IF-10X

This manual provides a description of the functions and logic of the programs and modules that make up the PALIS Basic Program. All logic common to both the automobile and other lines processing has been grouped together in the PALIS Basic Program.

This manual has been written in sections because of the many different and sometimes unrelated functions performed by the components of the PALIS Basic Program. The sections of this manual are:

- Section 1: Billing
- Section 2: Miscellaneous Functions
- Section 3: Statistical Reporting
- Section 4: Source Update Program
- Section 5: Sequenced Policy File Generator
- Section 6: Transchord Table Generator
- Section 7: Overlay Generator
- Section 8: Format Documentation Program
- Section 9: Run Linkage Test System
- Section 10: Transaction Edit Run
- Section 11: Transaction Sort
- Section 12: Run Linkage
- Section 13: File Support
- Section 14: Rateload
- Section 15: Standards
- Section 16: Controls

(208 pages)

GH20-0498 Property and Liability Information System (PALIS) Basic Operations Manual 60

Program Number: 360A-IF-10X

This manual provides information for the generation and operation of PALIS under System/360

Disk Operating System. It contains instructions for link editing the system, the console operating instructions, examples of job control decks, halt and message lists, storage diagrams, and restart procedures.

This manual has been written in sections because of the many different and sometimes unrelated functions performed by the components of the PALIS Basic Program. The sections of this manual are:

- Section 1: Preparatory System Procedures
- Section 2: Sample Problem
- Section 3: Transaction Edit Run
- Section 4: Transaction Sort
- Section 5: File Maintenance Run
- Section 6: File Support
- Section 7: Rateload
- Section 8: Utility Programs

A knowledge of System/360 Disk Operating System operating procedures, including the use of job control cards, is a prerequisite for reading and using this manual. (208 pages)

GH20-0499 Property and Liability Information System (PALIS) Automobile Premium Processing—Program Description and System Manual 60

Program Number: 360A-IF-11X

The purpose of this manual is to describe the Property and Liability Information System insurance logic programs to rate and prepare a declarations sheet extract for both the family combination policies and the special automobile (single limit liability) policy for all 50 states (with the exception of Massachusetts and Texas, the District of Columbia and Puerto Rico.) The rating plans supported are both the classification plan in effect prior to January 1, 1965 (henceforth referred to as the old class plan), and the new six-digit classification plan dated January 1, 1965, (henceforth known as the new class plan). Both plans will rate a maximum of four vehicles (including pickups, panels, sedan deliveries, and antiques), and five drivers per policy. Insurance logic is provided to rate all allowable combinations of the following coverages and endorsements: Liability (Bodily Injury, Property Damage, Medical Payments, and Uninsured Motorist), Comprehensive, Collision, Towing, Uninsured Motorist Named Insured, Death and Disability, Mobile Homes, and Minor Operators. The system also provides programs to rate the following additional physical damage coverages under the Old Classification Plan: Fire; Theft; Combined Additional Coverage (with or without malicious mischief and vandalism); Fire, Theft, and Combined Additional Coverage; Windstorm, Hail, Earthquake or Explosion; Riot and Civil Commotion (with or without malicious mischief and vandalism); and Personal Effects. (180 pages)

GH20-0500 Property and Liability Information System (PALIS) Automobile Claims Processing—Program Description and System Manual 60

Program Number: 360A-IF-11X

The purpose of this manual is to describe the Property and Liability Information System insurance logic for processing automobile claims.

Open claim information, taking the place of the traditional outstanding loss file, is stored in detail. Transactions for an open claim are entered into the system along with premium transactions, and the automobile master record is updated with the new information. If all claims are closed, they are summarized at purge time and carried forward to the renewal policy. As with the premium data, closed cases are also retained for historical purposes.

Premium and claims data for a policy are stored together so a historical picture of a risk is available in one place. Thus, underwriters have information required for individual risk experience.

Another significant portion of the PALIS approach to automobile claims is the processing of recoverable reinsurance. Excess reinsurance, if not input with the transaction, will be calculated by using an excess of loss reinsurance table. Other types of reinsurance applicable to a given coverage will be added into the calculated excess reinsurance recoverable. (40 pages)

GH20-0503 Property and Liability 60
Information System (PALIS) Other
Lines Premium Processing—Program
Description and System Manual

Program Number: 360A-IF-13X

The purpose of this manual is to describe the Property and Liability Information System other lines master record and the insurance logic necessary to accommodate the policy and premium information for single location risks in all lines of business normally written by a property and liability insurance company. While other lines policies are not related by PALIS, they are maintained in historical fashion and contain detailed descriptive information and statistical data. The master record is designed to provide information on the status and history of all policies. (60 pages)

GH20-0504 Property and Liability 60
Information System (PALIS) Other
Lines Claims Processing—Program
Description and System Manual

Program Number: 360A-IF-13X

This manual describes the Property and Liability Information System other lines master record and the insurance logic necessary to accommodate the loss information for single locations risks in all lines of business normally written by a property and liability insurance company.

Open claim information, taking the place of the traditional outstanding loss file, is stored in detail. Transactions for an open claim are entered into the system along with premium transactions, and the master record is updated with the new information. Statistical data is prepared as an output. In addition, closed claims are summarized at purge time and carried forward with the premium information. As with the premium data, closed cases are also retained for historical purposes.

This method of claims maintenance allows significant processing advantages in that statistical coding information for claims transactions is captured from the policy master record.

In addition, since all premium and claims data for all policies is stored together, a complete

historical picture of a risk is available in one place. Thus, underwriters have all information required for individual risk experience. (42 pages)

GH20-0505 MARVEL/360 Program 60
Description Manual

Program Number: 360A-CO-15X

This publication provides the information required to use the MARVEL programming language. It is a basic reference document for any user interested in the problems with which this system can help him. It is expected that the reader is thoroughly familiar with the contents of the MARVEL/360 Primer.

MARVEL is a language processor for the data preparation, matrix generation, output analysis, and management report writing functions associated with the Mathematical Programming System/360 (360A-CO-14X). MARVEL was designed and implemented to provide powerful functional capabilities in this fast growing area of mathematical programming. In providing such a comprehensive language and processor capability, "trade-offs" were made that reduced execution speed.

MARVEL will provide maximum customer utility as an input/output system for the development of new linear programming applications, because this is an area where extended function is more significant than high performance. In a production environment where emphasis is on execution speed, MARVEL will be less suitable. (184 pages)

GH20-0506 System/360 Vehicle 60
Scheduling Program—Program
Description and Operations Manual

Program Number: 360A-ST-06X

This manual contains specific information about the preparation for, the functions of, and the use of the IBM System/360 Vehicle Scheduling Program, as well as its operation under the IBM System/360 Disk Operating System. Detailed data preparation suggestions are explained under the program section to which they apply. The operations section contains a description of program setup and restart procedures, console operating instructions, and card layouts. In addition, the manual presents input/output descriptions, suggestions for option usage, lists of messages, and a sample problem.

The reader should be familiar with the *System/Description*, Order Number GH20-0464. (120 pages)

GH20-0507 Bibliography of Application 99
Publications Finance Industries

The purpose of this bibliography and the associated classification system is to list and categorize IBM application publications that are pertinent to finance industries. Section I lists these publications by application or industry. Section II contains an abstract of each publication, in form number sequence.

A periodic Bibliography of Application Publications (BAP) newsletter (GN20-1077) is published to

keep the bibliography up to date. The newsletter is divided into two sections. Section I is an updated listing of application publications by application or industry. This section also includes any corrections to the bibliography and a list of superseded publications. Section II contains an abstract of each publication not included in the last published bibliography. (26 pages)

GH20-0508 System/360 Administrative 60
Terminal System DOS (ATS/DOS)
Program Description Manual

Program Number: 360A-CX-18X

This manual may be used as a reference manual by application programmers that are concerned with the Administrative Terminal System, ATS/360, functioning under the IBM System/360 Disk Operating System (DOS). ATS/360 applications consist of control and functional programs that permit the simultaneous performance of many different text processing and data-handling activities on different terminals. This publication describes the principles and techniques of storage and real-time processing control for each of the programs that make up ATS/360, as well as information pertinent to their organization, scope, and planning for system applications and/or modifications to those applications. System generation procedures are also described and information regarding storage estimates and system timing is given. (136 pages)

GH20-0509 System/360 Administrative 60
Terminal System DOS (ATS/DOS)
Terminal Operator's Manual

Program Number: 360A-CX-18X

This manual contains procedures for operating the IBM Administrative Terminal System, ATS/360. Operation consists of manipulating the keyboard on the IBM 2741 Communications Terminal to send commands to the computer, enter documents into the system for storage, and print documents which have been previously stored.

Procedures are provided for using the terminal to send and receive messages in the form of documents from one terminal location to another, to transfer stored documents onto magnetic tape or punched cards, and to accomplish high-speed printing of stored documents at the computer center. Procedures are also included to bring documents into the system that are stored on punched cards and magnetic tape.

The procedures are arranged so that the operator can begin with the most basic commands and immediately start using the terminal while progressing through the remaining text and examples to understand the operating principles.

A summary is included at the end of some sections to provide a quick review for operators who only use the ATS/360 occasionally, or infrequently after exposure to the initial training period.

Four appendices are included. Appendix A provides a listing of operator commands. Appendix B provides a listing of computer responses. Appendix C provides a glossary of terms that are used throughout the manual. Appendix D consists of punched card codes and reference data for entering special characters and hexadecimal values at the terminal. (124 pages)

GH20-0510 System/360 Administrative Terminal System DOS (ATS/DOS) Application Description 60

Program Number: 360A-CX-18X

This system consists of control and functional programs that permit many different text-processing and data-handling activities to be carried on simultaneously through different terminals attached to an IBM System/360. Written to operate under DOS/360, the Administrative Terminal System will allow background programs to run concurrently with, and independently of, normal terminal operation.

This publication contains a general discussion of the features of the program, an indication of some of the areas in which it may be applied, and the machine configuration required. (28 pages)

GH20-0511 System/360 Administrative Terminal System DOS (ATS/DOS) Computer Center Operator's Manual 60

Program Number: 360A-CX-18X

This manual describes operating procedures for the IBM Administrative Terminal System, ATS/360. These procedures are designed for computer centers using the Disk Operating System (DOS) version of the IBM System/360 Model 30, 40, or 50F. ATS/360 computer centers using a different machine configuration may use this manual as a reference for establishing procedures for use with the system.

These procedures are intended for the computer center operator or other personnel using the equipment during scheduled operating periods to set up the system for ATS/360 applications, maintain the real-time capability while the system is in use, and shut down the system to terminate ATS/360 operations.

Any deviation from these procedures must be carefully considered to avoid introducing errors which could jeopardize the effectiveness of the system.

Special handling instructions and other computer center (CC) operator duties are described for servicing the requests of remote terminal (RT) operators, maintaining the security of records, off-line machine operations for peripheral equipment, and error recovery techniques.

The manual is divided into sections, each of which describes the overall system application, arrangement of equipment, and procedures for its use. (72 pages)

GH20-0512 MARVEL/360 Operations Manual 60

Program Number: 360A-CO-15X

This publication contains information that will enable the user to link-edit and incorporate the MARVEL/360 program into a system for subsequent execution under control of Mathematical Programming System/360. Detailed examples are given for editing the MARVEL/360 program into a private JOBLIB or the OS/360 SYS1.LINKLIB. (12 pages)

GH20-0513 Linear Programming System/360 (LPS/360)—Application Description 60

This program provides the System/360 Disk Operating System (DOS) user with a simple, easy to understand and easy to use means of solving LP problems, and with a powerful tool for implementing other mathematical optimization applications.

The system contains all the procedures necessary to solve an LP problem and to perform an extensive post-optimal analysis of the problem. The system provides extensive data generation and maintenance facilities.

To solve an LP problem, these procedures are called into core storage by procedure control statements that define the processing sequence.

This manual contains a description of the system, the required machine configurations, and limits on problem size. (20 pages)

GH20-0514 System/360 Model 44 Remote Access Computing System Application Description 60

This system is designed to allow multiple concurrent access to a System/360 Model 44 from remote terminals. RAX implements time-sharing techniques for the compilation and execution of user computing problems in FORTRAN and Assembler Languages. Also, it provides a Terminal Command Language to provide control of the terminal and to implement the use of the programming languages.

This publication contains a description of the system, the equipment requirements, the system capabilities, the elements of the Terminal Command Language, and a discussion of the system operation. (28 pages)

GH20-0515 System/360 Automated Chemistry Program (360 ACP) for the 1080 Data Acquisition System—Program Description Manual 60

Program Number: 360A-UH-12X

The IBM System/360 Automated Chemistry Program (360 ACP) is designed to process the punched card output of the IBM 1080 Data Acquisition System servicing continuous processing analyzer systems and one or more IBM 1084 Sampler Readers, all operating in a clinical laboratory environment.

The purpose of this manual is to provide the user with an understanding of the program necessary to implement the application. Included are descriptions of the two runs which make up 360 ACP, an input/output description, timing information, program modification aids, and a sample problem. (56 pages)

GH20-0516 System/360 Automated Chemistry Program (360 ACP) for the 1080 Data Acquisition System, Operations Manual 60

Program Number: 360A-UH-12X

System/360 Automated Chemistry Program (360 ACP) is designed to process the punched card output of the 1080 Data Acquisition System servicing

continuous processing analyzer systems and one or more IBM 1084 Sampler Readers, all operating in a clinical laboratory environment. The 360 ACP is composed of two runs—a file creation program and a process data program. The former is executed at the time the system is set up and need not be performed again unless the user wishes to change any of the files. The latter is the program designed to process the 1080 punched card output.

This manual gives the specifications and necessary information for operating 360 ACP. It includes a description of retrieval of data from distributed machine-readable material and cataloging programs in the user's core image library. Use of this manual requires an operating knowledge of the IBM Disk Operating System (DOS) job control cards and operating procedures. (32 pages)

GH20-0517 Advanced Life Information System Operations Manual 60

Program Number: 360A-IL-09X

This manual presents the information required to set up the Advanced Life Information System (ALIS) and to execute the ALIS programs. This system operates under the IBM System/360 Disk Operating System (DOS) and consists of a series of programs which are run in sequence. The ALIS programs are presented in the suggested running sequence. Suggestions on user program integration with ALIS are also made. The information applicable to all ALIS programs is presented once at the beginning of the manual. Following that information is a control card, console operating, message, error, restart, and external control information for each ALIS program. Operating instructions for the ALIS utility programs are also included. (132 pages)

GH20-0518 Advanced Life Information System Program Description Manual 60

Program Number: 360A-IL-09X

This manual contains information relating to the concepts, inputs, outputs, and processing methods used in the Advanced Life Information System (ALIS). This manual (1) provides the reader with the information required to understand the functions of ALIS and considerations for implementation of the system, (2) is designed as a guide to the user of other ALIS documentation, and (3) serves as pre-ALIS class reading. (256 pages)

GH20-0519 Advanced Life Information System Utility Program Description Manual 60

Program Number: 360A-IL-09X

This manual provides general information about the utility programs supplied with the Advanced Life Information System. The user should be familiar with the Operations manual to gain the necessary supplementary information to include the utility programs on his library and to execute them. (72 pages)

GH20-0521 System/360 Generalized Information System (Basic) Application Description Manual 60

This manual surveys the operational concepts and system capabilities of the Generalized Information System (Basic). It provides an introduction to the language of GIS and describes the file organization and processing actions supported by GIS.

The System/360 Generalized Information System (Basic) operates under control of the System/360 Operating System and supports a wide variety of applications by providing information handling capabilities against many typical data base organizations. As a system, GIS provides facilities for defining, maintaining, and retrieving data from user files under direction of the using installation and its personnel. (64 pages)

GH20-0522 Bibliography of Application Publications Distribution Industries 99

The purpose of this bibliography and the associated classification system is to list and categorize IBM application publications that are pertinent to distribution industries. Section I lists these publications by application or industry. Section II contains an abstract of each publication, in form number sequence.

A periodic Bibliography of Application Publications (BAP) newsletter (GN20-1853) is published to keep the bibliography up to date. The newsletter is divided into two sections. Section I is an updated listing of application publications by application or industry. This section also includes any corrections to the bibliography and a list of superseded publications. Section II contains an abstract of each publication not included in the last published bibliography. (26 pages)

GH20-0523 System/360 AD-APT/AUTOSPOT (OS) Numerical Control Processor Application Description 60

AD-APT/AUTOSPOT is a symbolic language designed to simplify the preparation of instructions for numerically controlled machine tools. This manual provides an introduction to both the AD-APT and AUTOSPOT languages. Included are language structure and elements, and system configuration.

This program will provide the OS/360 installation with the capability currently available in AD-APT/AUTOSPOT (360A-CN-09X) under DOS/360. (60 pages)

GH20-0524 Information Management System/360 for the IBM System/360 (System Description) Application Description Manual 60

The Information Management System/360 is an Operating System/360 processing program designed to facilitate the implementation of medium to large common data bases in a multiapplication environment. This environment is created to accommodate both online message processing and conventional batch processing, either separately or concurrently. The system permits the evolutionary

expansion of data processing applications from a batch-only to a teleprocessing environment.

This manual includes a general description of the system and its various facilities and programs, listings of typical and minimum configurations, and a sample application. (48 pages)

GH20-0525 System/360 Text Processor HYPHENATION/360 Program Description Manual 60

Program Number: 360A-DP-07X

HYPHENATION/360 provides division of words for text-processing applications in which the addition of word syllables to a line to meet justification requirements is preferable to forcing the line to end in a complete word. This hyphenation capability is provided in the form of a module that can be linked with a user's System/360 text-processing program or the COMPOSITION/360 component of the IBM System/360 Text Processor.

Through program linkage, the HYPHENATION/360 module accepts a word from the user's program and determines the division points. The word, with the division points indicated, is returned to the user's program, where the portion to be retained on the line can be selected on the basis of the user's graphic requirements.

This publication contains processing descriptions, core and disk requirements, timing information, and detailed instructions for the use of the HYPHENATION/360 module and its associated utility programs. A thorough understanding of the CALL, SAVE, and RETURN macros discussed in *IBM System/360 DOS Supervisor and Input/Output Macros*, Order Number GC24-5037 is a prerequisite for reading this publication. (68 pages)

GH20-0526 System/360 Text Processor HYPHENATION/360—Operations Manual 60

Program Number: 360A-DP-07X

HYPHENATION/360 provides division of words for text-processing applications in which the addition of word syllables to a line to meet justification requirements is preferable to forcing the line to end with a complete word. This hyphenation capability is provided in the form of a module that can be linked with a user's System/360 text-processing program or the COMPOSITION/360 module of the IBM System/360 Text Processor.

Through program linkage, HYPHENATION/360 accepts a word from the user's program and determines the division points. The word, with the division points indicated, is returned to the user's program, where the portion to be retained on the line can be selected on the basis of the user's graphic requirements.

This publication contains detailed preparatory system procedures; operating instructions, error messages, and restart procedures for the component programs; and programming system and machine requirements.

A knowledge of DOS operating procedures is a prerequisite for reading and using this manual. (36 pages)

GH20-0527 System/360 1287 Input Conversion Program—Program Description Manual 60

Program Number: 360A-DR-07X

This program consists of a Transaction Specification Compiler and an Operational Processor. The Compiler provides for the description of the format and processing logic to be applied to documents scanned by the IBM 1287 Optical Reader. The program module created by the Compiler is referenced by the Processor in order to convert the data from the documents to a conversion journal. This manual describes the general program logic, the input and output formats, and provides samples of each. (48 pages)

GH20-0528 System/360 1287 Input Conversion Program—Operations Manual 60

Program Number: 360A-DR-07X

The purpose of this manual is to provide the user with the information, instructions, and guidance necessary to:

1. Retrieve and prepare the programs for operation.
2. Prepare to use the system.
3. Operate the programs in the system.

(32 pages)

GH20-0530 Bibliography of Application Publications Public Utility Industries 99

The purpose of this bibliography and the associated classification system is to list and categorize IBM application publications that are pertinent to public utility industries. Section I lists these publications by application or industry. Section II contains an abstract of each publication, in form number sequence.

A periodic Bibliography of Application Publications (BAP) newsletter GN20-1866 is published to keep the bibliography up to date. The newsletter is divided into two sections. Section I is an updated listing of application publications by application or industry. This section also includes any corrections to the bibliography and a list of superseded publications. Section II contains an abstract of each publication not included in the last published bibliography. (14 pages)

GH20-0531 Bibliography of Application Publications Printing and Publishing Industries 99

The purpose of this bibliography and the associated classification system is to list and categorize IBM application publications that are pertinent to printing and publishing industries. Section I lists these publications by application or industry. Section II contains an abstract of each publication, in form number sequence.

A periodic Bibliography of Application Publications (BAP) newsletter GN20-1867 is published to keep the bibliography up to date. The newsletter is divided into two sections. Section I is an updated listing of application publications by application or industry. This section also includes any corrections to the bibliography and a list of superseded publications. Section II contains an abstract of each publication not included in the last published bibliography. (12 pages)

GH20-0532 System/360 Power System Planning for the Electric Utility Industry Application Description Manual 60

The Power System Planning (PSP) application program package is designed specifically for the IBM System/360. The package provides the electric utility planning engineer with the most important digital simulation programs for studying the steady-state and transient operational characteristics of present and projected interconnected power networks. The package provides for the storing of data describing electric networks and the convenience of automatic data preparation for the simulation programs.

This manual contains a general description of the application, the machine configuration required, a general system flowchart, and four system charts covering the data storage and retrieval program and the three electrical network simulation programs provided within the package. (36 pages)

GH20-0533 Shared Hospital Accounting System (SHAS) Program Description Manual 60

Program Number: 360A-UH-11X

The Shared Hospital Accounting System (SHAS) provides hospital accounting for a multiple-hospital environment. The participating hospitals are connected to the central System/360 facility by teleprocessing terminals. SHAS consists of application programs and a teleprocessing executive. The application programs are patient billing, accounts receivable, and general ledger including accounting for both inpatients and outpatients. This manual refers to the accounts receivable portion of SHAS. References to teleprocessing and other applications have been minimized but still may be present to be consistent with subsequent manuals dealing with the entire system.

This basic publication provides information on the Shared Hospital Accounting System program to enable the user to understand the function of all of the SHAS programs as a guide for preparing to install SHAS.

This document is written as a reference manual and not as a study text. For education purposes this manual should be used in conjunction with the *SHAS Application Description Manual*, Order Number GH20-0302 and the *SHAS Operations Manual*, Order Number GH20-0534.

The organization is such that the reader can easily find in-depth information on what the program does for the user. It also helps the user connect that information with the programs through the use of

program references, COBOL tags, and modular descriptions following modular programs. The user can turn to a given program description and find the information immediately without having to read the entire section, and can easily relate the information directly to the program and the code.

This manual is written for systems engineers or programmers with a thorough understanding of DOS, COBOL, and System/360 Basic Assembler Language. (188 pages)

GH20-0534 Shared Hospital Accounting System (SHAS) Operations Manual 60

Program Number: 360A-UH-11X

The Shared Hospital Accounting System (SHAS) provides hospital accounting for a multiple-hospital environment. The participating hospitals may be connected to the central System/360 facility by teleprocessing terminals. SHAS consists of application programs and a teleprocessing executive. The application programs are patient billing, accounts receivable, and general ledger, including accounting for both inpatients and outpatients.

The basic publication gives the specifications and necessary information for operating the SHAS programs. It includes a description of retrieving data from distributed machine-readable material and cataloging programs in the user's core image library. Use of this manual requires an operating knowledge of the IBM Disk Operating System (DOS) job control cards and operating procedures.

This document is written as a reference manual for central operation and user-hospital personnel. User hospitals will find guidance for installation preparation, data coding and creation, and options available during operation. For education purposes, this manual should be used in conjunction with the *Shared Hospital Accounting System Application Description Manual*, Order Number GH20-0302 and the *Shared Hospital Accounting System Program Description Manual*, Order Number GH20-0533. (636 pages)

GH20-0535 PLAN Graphics Support for the IBM 2250—Application Description Manual 60

PLAN Graphics Support is designed to drastically reduce the time required to convert existing applications or create new applications for graphic displays. This system supports Models 1, 3, and 4 of the IBM 2250 Display Unit.

With PLAN Graphics Support, the application programmer works at a level where he is relieved from tedious graphic programming. High-level statements allow the application programmer to simply state the format, content, and control options that are desired by the console operator (the application user). By means of user-oriented statements, the application programmer may rapidly extend his existing application program or create new applications to include interactive graphic capability.

Among the graphic interface features supported are:

1. Graphic Output—Data generated by the application may be displayed using points, characters, vectors, or geometric shapes.

2. Graphic Input—Data may be created or modified at the console and passed to the application via the Light Pen, Programmed Function Keyboard, and Alphameric Keyboard.

3. Monitoring and Control—Intermediate results can be examined in an application. The console user dynamically controls the next function of the application program to be executed.

PLAN (Problem Language ANalyzer), a Type II program is used as a base for PLAN Graphics Support. Since it coexists with PLAN, the user has access to all of the functional capability in PLAN. PLAN Graphics Support and PLAN support both the IBM 1130 and System/360. (24 pages)

GH20-0536 Bibliography of Application Publications Insurance Industry 99

The purpose of this bibliography and the associated classification systems is to list and categorize IBM application publications that are pertinent to the insurance industry. Section I lists these publications by application or industry. Section II contains an abstract of each publication, in form number sequence.

A periodic Bibliography of Application Publications (BAP) newsletter (GN20-1869) is published to keep the bibliography up to date. The newsletter is divided into two sections. Section I is an updated listing of application publications by application or industry. This section also includes any corrections to the bibliography and a list of superseded publications. Section II contains an abstract of each publication not included in the last published bibliography. (22 pages)

GH20-0537 Data Acquisition Multiprogramming System/360 Model 44 (DAMPS) Program Description Manual 60

Program Number: 360A-CX-20X

This publication contains detailed information for preparing programs to be executed under DAMPS. It discusses the system's requirements and capabilities, and the facilities that are available as a result of the DAMPS extensions to the System/360 Model 44 Programming System. (78 pages)

GH20-0538 Data Acquisition Multiprogramming System/360 Model 44 (DAMPS) Operations Manual 60

Program Number: 360A-CX-20X

This publication describes the operations that are required to run, construct, or modify the Data Acquisition Multiprogramming System/360 Model 44. This publication assumes that the reader has operating knowledge of the IBM System/360 Model 44 Programming System. (36 pages)

GH20-0539 Graphic Analysis of Three-Dimensional Data (GATD): Application Description Manual 60

Program Number: 5734-XX2

Graphic Analysis of Three-Dimensional Data (GATD) is an application system built around the IBM 2250 Display Unit that allows online analysis of three-dimensional data. GATD operates in conjunction with Operating System/360, Problem Language Analyzer (PLAN), and PLAN Graphics Support (PGS).

This manual gives an overview of the functional capabilities of GATD and provides an example of system usage. (28 pages)

GH20-0540 Retail IMPACT Fashion System under Disk Operating System/360 Program Description Manual 60

Program Number: 360A-DR-08X

The IBM Retail IMPACT Fashion System consists of programs and procedures designed to provide the retailer with timely and accurate information for fashion merchandising. The system provides reorder recommendations, return recommendations, and other action reports to assist the fashion merchandiser in responding to changes in the volatile fashion market.

This manual describes the concepts, characteristics, and implementation of the Fashion System. Operational controls, report interpretation, and complete file specifications are included. The programs are described conceptually and specifically. Input, output, and processing information is included along with program modification aids. This manual provides the information and guidance necessary for planning and installation of the system. (184 pages)

GH20-0541 Retail IMPACT Fashion System under Disk Operating System/360 Operations Manual 60

Program Number: 360A-DR-08X

This manual provides instructions and guidance for operating the programs in the IBM Retail IMPACT Fashion System. The major components of the manual describe (1) preparatory information and procedures, (2) operations, and (3) retrieving the programs from the distribution tape, preparing the system, and running the sample problem. (40 pages)

GH20-0544 System/360 Scientific Subroutine Package (PL/I) Application Description Manual 60

Program Number: 360A-CM-07X

The System/360 Scientific Subroutine Package (SSP) (PL/I) is a collection of mathematical and statistical subroutines (or procedures) written in the PL/I language. It provides the PL/I user with most of the basic capabilities in earlier FORTRAN versions of SSP/360. It also has the same basic characteristics as the FORTRAN versions, in that it consists of input/output-free computational

building blocks, written completely in PL/I, which may be combined with a user's input, output, or computational routines as needed. The package may be applied to the solution of many problems in industry, science, and engineering.

This Application Description presents an introduction to SSP/360 (PL/I), a list of the capabilities of the package, rules of usage, machine configuration, programming systems, and a list of reference material. (20 pages)

GH20-0545 System/360 Remote Access Computing System (RAX) Version 4 Application Description 60

Program Number: 360A-CX-17X

This system is designed to allow multiple concurrent access to a System/360 processor from remote terminals. RAX implements time-sharing techniques for the compilation and execution of user computing problems in FORTRAN and Assembler languages. Also, it provides a Terminal Command Language to provide control of the terminal and to implement the use of the programming languages.

This publication contains a description of the system, equipment requirements, system capabilities, and the elements of the Terminal Command Language, as well as a discussion of the system operation. (32 pages)

GH20-0549 System/360 AD-APT/AUTOSPOT (OS) Numerical Control Processor Part Programming Manual 60

Program Number: 360A-CN-12X

The IBM N/C 360 adaptation of APT for small computers (AD-APT) uses a symbolic language to simplify the preparation of instructions for numerically controlled machined tools. The AD-APT processor prepares intermediate data for a user-written postprocessor program.

This manual contains the definition and examples of the AD-APT symbolic language. (168 pages)

GH20-0550 Shared Hospital Accounting System (SHAS) Teleprocessing Operations Manual 60

Program Number: 360A-UH-11X

The Shared Hospital Accounting System (SHAS) provides hospital accounting for a multiple-hospital environment. The participating hospitals are connected to the central System/360 facility by teleprocessing terminals. SHAS consists of application programs and a teleprocessing executive.

The application programs are patient billing, accounts receivable, and general ledger, including accounting for both inpatients and outpatients.

This publication gives the specifications and necessary information for operating the SHAS teleprocessing programs. This manual also includes a description of how to assemble and operate the teleprocessing system. Operation of AR inquiry procedure is included.

For the installation of the system knowledge of teleprocessing and QTAM under DOS is required. Prerequisites for the 1050 teleprocessing terminal setup and maintenance of the *IBM 1050 Operator's Guide*, Order Number GA24-3125 and *Procedures for Transmitting/Receiving Messages between an IBM Data Processing System and a 1050 Data Communication System*, Order Number C20-1664. (72 pages)

GH20-0555 System/360 Inventory Control Program Description Manual 60

Program Number: 360A-MF-04X

The IBM inventory control application consists of a group of integrated programs and techniques designed for the selection and implementation of order point inventory control where it applies in manufacturing organizations.

The programs provide for (1) analysis and classification of inventory items, (2) calculation of economic order quantities on the basis of usage information or future requirements, (3) computation of safety stock and order point, (4) projection of demand on the basis of historical data, and (5) basic programs for transaction processing and status report preparation.

This manual includes a description of the programs and the processing; the definition of input, output, and files; a discussion of the the program options and macros; and instructions for modifying the programs. The appendices offer a sample problem with illustrations of the program input and output, in addition to tables and formulas utilized within the programs. (252 pages)

GH20-0556 System/360 Inventory Control Operations Manual 60

Program Number: 360A-MF-04X

System/360 Inventory Control consists of nine programs designed to assist in the implementation of order point inventory control in manufacturing organizations.

This manual contains information regarding preparatory and operating procedures for the programs. It includes a complete list of the console messages that can be produced by the program. (36 pages)

GH20-0557 System/360 AD-APT/AUTOSPOT (OS) Numerical Control Processor Operations Manual 60

Program Number: 360A-CN-12X

This manual provides suggested processor generation and maintenance techniques, program setup instructions, console operation instructions, halts and error messages, storage map, and restart procedures. (12 pages)

GH20-0558 System/360 Array Processing Subroutine Package Application Description Manual 60

The Array Processing Subroutine Package is a set of subroutines designed to enhance and simplify the

use of the IBM 2938 Array Processor, and to provide a series of analytical methods for use in digital signal analysis. (20 pages)

GH20-0559 System/360 Matrix Language (MATLAN) Operations Manual 60

Program Number: 360A-CM-05X

This manual provides detailed information to generate a MATLAN system and to run MATLAN programs. (124 pages)

GH20-0560 Mathematical Programming System/360 Report Generator (MPSRG) Program Description Manual 60

Program Number: 360A-CO-20X

This manual provides the system user with the information required to prepare input data and a report program. It is a basic reference document for any user of MPSRG. All MPSRG procedures are fully explained in this manual.

This manual assumes that the user is familiar with the *MPS/360 Application Description*, Order Number GH20-0136, the *MPS/360 Control Language User's Manual*, Order Number GH20-0290, and the *MPS/360 Linear and Separable Programming User's Manual*, Order Number GH20-0476. (60 pages)

GH20-0561 Mathematical Programming System/360 Report Generator (MPSRG) Operations Manual 60

Program Number: 360A-CO-20X

This manual contains complete information regarding the preparatory and operating procedures for the MPS/360 Report Generator. (32 pages)

GH20-0563 IBM System/360 Model 44 Remote Access Computing System RAX/44 Operations Manual 60

Program Number: 360A-CX-21X

This publication provides the System/360 machine operator with detailed instructions for starting, running, and stopping the Remote Access Computing System (RAX). It includes machine requirements, description of online messages and their meanings, and restart procedures. This manual also includes the procedures required for system generation and library maintenance. (36 pages)

GH20-0564 System/360 Matrix Language (MATLAN) Program Description Manual 60

Program Number: 360A-CM-05X

MATLAN is a programming system, operating under the control of System/360 Operating Systems, that is designed to simplify handling of and

computation with matrices. This publication describes the MATLAN language in detail and includes description of the statements, programming considerations, and examples. (224 pages)

GH20-0565 IBM System/360 Model 44 Remote Access Computing System RAX/44 Program Description Manual 60

Program Number: 360A-CX-21X

This publication provides the information necessary to use the IBM System/360 Model 44 Remote Access Computing System (RAX). It contains a description of the system which provides concurrent access to a System/360 Model 44 for up to 63 remote 1050 IBM Data Communication Terminals and eight 2260 Display Station locations. This system provides for the compilation and execution of FORTRAN IV and Assembler Language programs and the maintenance of program and data files in a library structure. (80 pages)

GH20-0572 System/360 Decision Logic Translator Program Description Manual 60

Program Number: 360A-CX-32X

The Decision Logic Translator program translates decision tables punched in cards into a FORTRAN source program. The FORTRAN source program is either punched in cards or stored on disk or tape ready for compilation. This manual contains information needed by the reader to understand the functions performed by the Decision Logic Translator. A sample problem shows how to use the decision table language to program an application. (36 pages)

GH20-0573 System/360 Decision Logic Translator Operations Manual 60

Program Number: 360A-CX-32X

This manual contains information on the preparation and operation of the Decision Logic Translator program. It is designed to translate decision tables (punched into cards in a prespecified format) into a FORTRAN program (stored on disk, on tape, or on cards) ready for compilation. The reader should be familiar with the contents of the following publications:

IBM System/360 Disk Operating System—System Control and System Service Programs, Order Number GC24-5036

IBM System/360 Decision Logic Translator Application Description Manual, Order Number GH20-0492

IBM System/360 Decision Logic Translator Program Description Manual, Order Number GH20-0572

(20 pages)

GH20-0574 System/360 Generalized Information System Application Description Manual 60

This manual surveys the operational concepts and system capabilities of the Generalized Information

System (GIS). It provides an introduction to the language of GIS and describes the file organization and processing actions supported by GIS.

The System/360 Generalized Information System operates under control of the IBM System/360 Operating Systems and uses the "Multiprogramming with a Variable Number of Tasks" (MVT) feature. GIS is designed to operate in a terminal environment using the Queued Telecommunications Access Method and supports a wide variety of applications by providing information handling capabilities against many typical data base organizations. As a system, GIS provides facilities for defining, maintaining and retrieving data from user files under direction of the using installation and its personnel. (80 pages)

GH20-0577 Program for Optical System Design/II (POSD/II) Program Description Manual 60

Program Numbers:

1130-EO-14X

360A-EO-15X

360A-EO-16X

This manual provides information detailing the set of options available to POSD/II users and the techniques used in all calculations. A sample problem is used throughout the body of the text for illustrative purposes only. A separate, comprehensive problem is shown in Appendix A to demonstrate the overall capability of the POSD/II system, including output formats.

References are made throughout the text to the Problem Language Analyzer (PLAN) system, an IBM-supplied submonitor program that serves as an interface between various monitor systems and programs such as POSD/II. Through PLAN, users can supplement standard application program versions with their own procedures.

The user is referred to the POSD/II Operator's Manual for specific machine instructions. (160 pages)

GH20-0578 Program for Optical System Design/II (POSD/II) Operations Manual 60

Program Numbers:

1130-EO-14X

360A-EO-15X

360A-EO-16X

This manual is intended to serve as an instruction guide to the operation and use of POSD/II. It presents the specific operating details and summarizes user information extracted from the Program Description Manual. (72 pages)

GH20-0579 System/360 Text Processor COMPOSITION/360 Operations Manual 60

Program Number: 360A-DP-08X

The COMPOSITION/360 component of the IBM System/360 Text Processor consists of control and

functional routines which retrieve text from a user-prepared disk-resident file, justify and format text according to instructions supplied with the text, and produce generalized disk output records. The user must provide routines to retrieve this generalized information, convert it into coding acceptable to the specific composition device on which final printing will occur, and write it to the appropriate systems output device. If word division capabilities are required, COMPOSITION/360 uses the HYPHENATION/360 component of the System/360 Text Processor (360A-DP-07X).

This publication contains detailed preparatory systems procedures; operating instructions, error messages, and restart procedures for the component programs; and programming system and machine requirements.

A detailed knowledge of DOS operating procedures is a prerequisite for reading and using this manual. (108 pages)

GH20-0582 System/360 Administrative 60
Terminal System—OS (ATS/OS)
Program Description Manual

Program Number: 360A-CX-19X

This manual may be used as a reference manual by application programmers who are concerned with the Administrative Terminal System, ATS/360 functioning under the IBM System/360 Operating System (OS) MFT II or MVT. ATS/360 applications consist of control and functional programs that permit, concurrently, the performance of many different text-processing and data-handling activities on separate terminals. This publication describes the principles and techniques of storage and real-time processing controls for each of the programs that make up ATS/360, as well as information pertinent to their organization, scope, and planning for system applications and/or modifications to those applications. System generation procedures are described and information regarding storage estimates and system timing is given. (138 pages)

GH20-0583 System/360 Requirements 60
Planning Operations Manual

Program Number: 360A-MF-05X

System/360 Requirements Planning consists of two programs, the Requirements Generation Program, which is a multi-phase, and the Print Exception Program. It is designed to assist in the implementation of a requirements planning application in manufacturing organizations.

This manual contains information regarding preparatory and operating procedures for the programs. It includes a complete list of the console messages that can be produced by the programs. (36 pages)

GH20-0584 System/360 Requirements 60
Planning Program Description Manual

Program Number: 360A-MF-05X

The IBM System/360 Requirements Planning programs are used to generate material requirements for finished products, assemblies, subassemblies, parts, and raw materials on the basis of an input of

forecast and/or orders. System 360 Requirements Planning consists of two programs. Requirements Generation Program and Print Exception Program. Requirements Generation performs the generation of requirements utilizing time series planning to do the following: determine gross requirements, determine net requirements, plan orders, determine offset, and post component requirements. Print Exception prints exception notices covering exceptions discovered during the Requirements Generation run.

This manual includes (1) customizing procedure for generating the System/360 Requirements Planning programs, (2) detail description of the Requirements Generation program, (3) detail description of the Print Exception program, (4) description of all I/O files, and (5) explanation and operating instructions for the sample problem.

The material in this publication is presented with the assumption that the user has studied the following:

System/360 Requirements Planning, Application Description, Order Number GH20-0487.

System/360 Bill of Material Processor (360A-ME-06X) Application Description, Order Number GH20-0197.

System/360 Bill of Material Processor (360A-ME-06X) Programmer's Manual, Order Number GH20-0246. (152 pages)

GH20-0585 System/360 Text Processor 60
COMPOSITION/360 Program
Description Manual

Program Number: 360A-DP-08X

The COMPOSITION/360 component of the IBM System/360 Text Processor consists of control and functional routines which retrieve text from a user-prepared disk-resident file, justify and format text according to instructions supplied with the text, and produce generalized disk output records. The user must provide routines to retrieve this generalized information, convert it into coding acceptable to the specific composition device on which final printing will occur, and write it to the appropriate systems output device. If word division capabilities are required, COMPOSITION/360 uses the HYPHENATION/360 component of the System/360 Text Processor (360A-DP-07X).

This publication contains an explanation of the format control languages supported, processing and file descriptions, system and machine requirements, timing information, examples, and preinstallation requirements for use of the COMPOSITION/360 module and its associated utility programs. A detailed knowledge of DOS operating procedures is a prerequisite for reading and using this manual. (208 pages)

GH20-0586 System/360 Scientific 60
Subroutine Package (PL/I)—Program
Description and Operations Manual

Program Number: 360A-CM-07X

The System/360 Scientific Subroutine Package (SSP) (PL/I) is a collection of mathematical and statistical subroutines (or procedures) written in the PL/I language. It provides the PL/I user with

most of the basic capabilities in earlier FORTRAN versions of SSP/360. It also has the same basic characteristics as the FORTRAN versions, in that it consists of input/output-free computational building blocks, written completely in PL/I, which may be combined with a user's input, output, or computational routines as needed. The package may be applied to the solution of many problems in industry, science, and engineering.

This manual contains sufficient information to permit the reader to understand and use all of the subroutines in the Scientific Subroutine Package. (304 pages)

GH20-0588 Advanced Life Information 60
System Home Office Inquiry
Program—Terminal Operations
Manual

Program Number: 360A-IL-09X

This manual provides terminal operators and department personnel with operating instructions and input/output for home office inquiry use. (44 pages)

GH20-0589 System/360 Administrative 60
Terminal System—OS (ATS/OS)
Terminal Operations Manual

Program Number: 360A-CX-19X

This manual contains procedures for operating the IBM Administrative Terminal System (ATS/360). Operation consists of manipulating the keyboard on the IBM 2741 Communications Terminal to send commands to the computer, entering documents into the system for storage, and printing documents which have been previously stored.

Procedures are provided for using the terminal to send and receive messages in the form of documents from one terminal location to another, for transferring stored documents onto magnetic tape or punched cards, and for high-speed printing of stored documents at the computer center. Procedures are also included to bring documents into the system that are stored on punched cards and magnetic tape. The procedures are arranged so that the operator can begin with the most basic commands and immediately use the terminal while progressing through the remaining text and examples to understand the operating principles. A summary is included at the end of some sections to provide a quick review. (136 pages)

GH20-0590 System/360 Administrative 60
Terminal System—OS (ATS/OS)
Console Operations Manual

Program Number: 360A-CX-19X

This manual contains ATS/360 operating instructions for the computer center (console) operator. The instructions are to be followed when ATS/360 is under control of System/360 Operating System, MFT II or MVT. The instructions tell the computer center operator how to start up and shut down ATS/360 and how to service the requests from the remote ATS terminals on the system.

The console operator should be familiar with the contents of the following publications:
IBM System/360 Principles of Operation, Order Number GA22-6821.

- IBM System/360 System Summary*, Order Number GA22-6810.
- IBM System/360 Operating System Introduction*, Order Number GC28-6534.
- IBM System/360 Operating System Operator's Guide*, Order Number GC28-6540.
- IBM System/360 Administrative Terminal System DOS (ATS/DOS) Terminal Operator's Manual*, Order Number GH20-0509.
- IBM System/360 Administrative Terminal System DOS (ATS/DOS) Program Description Manual*, GH20-0508. (44 pages)
- GH20-0591 System/360 Retail IMPACT Staple System (OS) Program Description Manual** 60
Program Number: 360A-DR-05X
 The Retail IMPACT Staple System is designed to provide the retail industry with an integrated inventory management system for staple departments. This manual describes the individual programs that make up the Staple System, their relationships to one another, and their use in the management of staple merchandise. The document covers the inputs to and outputs from the various programs and explains the various options available to the user. (708 pages)
- GH20-0592 System/360 Retail IMPACT Staple System (DOS)—Operations Manual** 60
Program Number: 360A-DR-09X
 The Retail IMPACT Staple System is designed to provide the retail industry with an integrated inventory management system for staple departments. This manual describes the operation of the various programs under DOS/360. Included are: console messages produced by the programs, control card descriptions, information on file requirements, sample job control for running the programs, and information necessary to compile the programs. (88 pages)
- GH20-0593 System/360 Retail IMPACT Staple System (OS) Operations Manual** 60
Program Number: 360A-DR-05X
 The Retail IMPACT Staple System gives the retail industry an integrated inventory management system for staple departments. This manual describes the operation of the various programs under OS/360. Included are: console messages produced by the programs, control card descriptions, information on file requirements, sample job control for running the programs, and information necessary to compile the programs. (140 pages)
- GH20-0594 Problem Language Analyzer (PLAN) Program Description Manual** 60
Program Numbers:
 1130-CX-25X
 360A-CX-26X
 360A-CX-27X
- This system provides users with an efficient means of implementing and using meaningful user-oriented (problem-oriented) languages. This manual is intended to provide rules for use of the system and technical specifications defining the scope of applicability. It is intended to serve as a user's and an implementer's reference. (168 pages)
- GH20-0596 System/360 Problem Language Analyzer (PLAN) (OS)—Operations Manual** 60
Program Number: 360A-CX-27X
 This manual is intended to assist users in the implementation and execution of PLAN jobs using OS/360. It includes specifications pertinent to only the System/360 OS version of PLAN. Sections of special interest pertain to debugging, diagnostics, and abnormal termination. This manual should be read before attempting any computer operations. (64 pages)
- GH20-0597 System/360 Problem Language Analyzer (PLAN) (DOS)—Operations Manual** 60
Program Number: 360A-CX-26X
 This manual is intended to assist users in the generation and execution of PLAN jobs using DOS/360. PLAN specifications as they pertain specifically to DOS/360 are discussed. A thorough discussion of considerations for using data sets are included. Instructions for processing optional machine readable material are provided. (60 pages)
- GH20-0599 System/360 Retail IMPACT Staple System (DOS)—Program Description Manual** 60
Program Number: 360A-DR-09X
 The Retail IMPACT Staple System is designed to provide the retail industry with an integrated inventory management system for staple departments. This manual describes the individual programs that make up the Staple System, their relationships to one another, and their use in the management of staple merchandise. The document covers the inputs to and outputs from the various programs and explains the various options available to the user. (200 pages)
- GH20-0604 System/360 Order Allocation System—Application Description Manual** 60
 The Order Allocation System is designed to assist apparel manufacturers in the task of assigning, or allocating, available inventory to open orders in a manner consistent with management objectives and direction.
 Input to the system consists of the user's order and inventory files and the rules to be followed in accomplishing the allocation function. Output from the system consists of picking documents and updated order and inventory files, as well as various listings, reports, and control totals. (32 pages)
- GH20-0607 Linear Programming System/360 (LPS/360) Program Description Manual** 60
Program Number: 360A-CO-18X
 This manual describes how to use Linear Programming System/360. Chapter 1 is written in tutorial form to present concepts to new users. The rest of the manual describes the system procedures and data formats. (128 pages)
- GH20-0611 Linear Programming System/360 (LPS/360) Operations Manual** 60
Program Number: 360A-CO-18X
 This manual contains operating instructions that will enable the user to prepare and run LPS/360 under the System/360 Disk Operating System. (32 pages)
- SH20-0613 Rigid Frame Selection Program (RFSP) Program Description Manual** 65
Program Numbers:
 5734-EC1
 5736-EC1
 This manual must be used in conjunction with IBM 1130 Rigid Frame Selection Program (RFSP), Program Description and Operations Manual (GH20-0580), as updated by Technical Newsletters. The pages in this manual correspond to those that appear in GH20-0580 (the areas of change are highlighted by a vertical rule to the left of the change).
 Used as above this manual contains a complete description of RFSP for the program users. A general outline of the application, its components and its organization is followed by detailed instructions for the utilization of the various features of the program. Sample Problems are used for illustration. The appendices describe the analysis and design methodology used in the program and provide listings of program modules, files, and tables. (16 pages)
- GH20-0627 System/360 Capacity Planning Infinite Loading; System/360 Capacity Planning—Finite Loading; Application Description Manual** 65
Program Numbers:
 5736-M11
 5736-M12
 The System/360 Capacity Planning program products are designed to meet the needs of manufacturers who purchase and make subassemblies and parts for large and complex end items or who purchase, make, and then stock parts and subassemblies for later assembly in a variety of end products. The program product System/360 Capacity Planning—Infinite Loading (5736-M11) provides the necessary logic to:
 1. Determine the required labor or machine hours necessary to meet a given set of order requirements.

2. Load orders to infinite capacity.

The program product System/360 Capacity Planning—Finite Loading (5736-M12) provides all of the logic of program product 5736-M11 and also provides the logic to:

1. Perform single-level pegging.
2. Load orders in a priority sequence up to the limit of known capacity.
3. Move the order to a time period that has available capacity when bottlenecks are discovered.
4. Establish order start dates for components, subassemblies, and final assemblies consistent with available plant capacity.

Both program products require data from an item master or subordinate item master file, a standard routing file, and a work center master file as created and maintained by the System/360 Bill of Material Processor (360-ME-06X).

Infinite Loading (5635-M11) requires planned order information as created by System/360 Requirements Planning, Program Product 5736-M13 or Program Number 360A-MF-05X.

Finite Loading (5736-M12) requires connection record (single-level pegging) information as created by program product System/360 Requirements Planning (5736-M13). (72 pages)

GH20-0646 Advanced Life Information 60
System Input Edit Program System
Manual

Program Number: 360A-IL-09X

This manual provides detailed information to help understand program logic. It describes processing of transaction items produced by the batch edit program and also describes the creation of external file maintenance transactions. Appropriate flowcharts, flowchart narratives, input/output formats, tables and descriptions, and program modification aids are included. (544 pages)

GH20-0647 Advanced Life Information 60
System Frequently Used Record
Formats System Manual

Program Number: 360A-IL-09X

This manual contains the transaction data area formats, the miscellaneous data area formats, and policy master record formats. The transaction data area formats illustrate the output from the input edit program and the input to the file maintenance program. The transaction data area formats also illustrate a portion of certain output messages from the file maintenance program. The miscellaneous data area formats illustrate a portion of certain output messages from the file maintenance program. Both the transaction data area formats and the miscellaneous data area formats are a part of the input and output for many of the output programs. In the documentation for the output programs reference is made to *Frequently Used Record Formats* for illustration of the exact nature of portions of the input or output message. (84 pages)

GH20-0648 Advanced Life Information 60
System Miscellaneous Volume System
Manual

Program Number: 360A-IL-09X

This manual contains sections on customer constants, customer tables, file maintenance account numbers and customer account strips, file maintenance message codes, transaction codes, and file maintenance work areas. The information in this manual will be referred to by many system manuals, particularly the file maintenance system manuals. (244 pages)

GH20-0649 Advanced Life Information 60
System File Maintenance Run
Executive Program System
Manual

Program Number: 360A-IL-09X

This manual provides detailed information to help understand program logic. This manual describes control of all file maintenance processing. Also described is the creation of file maintenance messages for the output analysis program, policy master record updating, and creation of restart records for the data cell restore program. Appropriate flowcharts, flowchart narratives, input/output formats, and work area descriptions are included. (136 pages)

GH20-0650 Advanced Life Information 60
System Data Cell Reorganization
Program, Policy Master Record Merge
Program, Data Cell Reconstruction
Program, and Data Cell Restore
Program System Manual

Program Number: 360A-IL-09X

This manual describes the policy master record file organization on the IBM 2321 Data Cell Drive and the programs which were written to (1) initially load the data cell file, (2) reorganize the data cell file, (3) reconstruct a data cell, (4) provide restart procedures, and (5) maintain backup tape files. The following text describes the file organization and introduces the programs. A complete description of each program is provided in a subsequent section. (96 pages)

GH20-0651 Advanced Life Information 60
System File Maintenance Include (R)
Routines (Narratives) System Manual

Program Number: 360A-IL-09X

This manual provides detailed information to help the user understand program logic. It includes a general description of each file maintenance include (R) routine. This manual should be used with the File Maintenance Include (R) Routines (Flowcharts) to obtain a more detailed understanding of the processing in each include routine. (512 pages)

GH20-0652 Advanced Life Information 60
System File Maintenance Include (R)
Routines (Flowcharts) System
Manual

Program Number: 360A-IL-09X

This manual provides detailed information to help the user understand program logic. It contains a flowchart for each file maintenance include (R) routine. This manual should be used with the File Maintenance Include (R) Routines (Narratives) to obtain a more detailed understanding of the processing in each include routine. (684 pages)

GH20-0653 Advanced Life Information 60
System File Maintenance Call (S)
Routines (Narratives) System Manual

Program Number: 360A-IL-09X

This manual provides detailed information to help the user understand program logic. It includes a general description of each file maintenance call (S) routine. This manual should be used with the File Maintenance Call (S) Routines (Flowcharts) to obtain a more detailed understanding of the processing in each call (S) routine. (612 pages)

GH20-0654 Advanced Life Information 60
System File Maintenance Call (S)
Routines (Flowcharts) System Manual

Program Number: 360A-IL-09X

This manual provides detailed information to help the user understand program logic. It contains a flowchart for each file maintenance call (S) routine. This manual should be used with the File Maintenance Call (S) Routines (Narratives) to obtain a more detailed understanding of the processing in each call (S) routine. (604 pages)

GH20-0655 Advanced Life Information 60
System File Maintenance Issues,
Additions, Complex Changes, and
Terminations Transactions System
Manual

Program Number: 360A-IL-09X

This manual provides detailed information to help the user understand the processing for issues, additions, complex changes, and terminations in the file maintenance program. It describes the processing for the respective transactions. A program abstract, narratives, and flowcharts are provided. (48 pages)

GH20-0656 Advanced Life Information 60
System File Maintenance Simple
Changes Transactions System Manual

Program Number: 360A-IL-09X

This manual provides detailed information to help the user understand the simple change processing. It describes the external file maintenance transactions that add, delete, or replace individual policy master record fields and/or trailers. A program abstract, narratives, and flowcharts are provided. (196 pages)

GH20-0657 Advanced Life Information 60
System File Maintenance 36XX
Financial Transactions-Payments
System Manual

Program Number: 360A-IL-09X

This manual provides detailed information to help the user understand payment processing in the file maintenance program. It describes financial processing for all payment transactions. A program abstract, narratives, and flowcharts are provided. (80 pages)

GH20-0658 Advanced Life Information 60
System File Maintenance Financial
Transactions-Accounting Entries
System Manual

Program Number: 360A-IL-09X

This manual provides detailed information to help the user understand accounting entry processing in the file maintenance program. It describes financial processing for all accounting adjustment transactions. A program abstract, narratives, and flowcharts are provided. (132 pages)

GH20-0659 Advanced Life Information 60
System File Maintenance Status
Transactions-Process and Quote
Terminations System Manual

Program Number: 360A-IL-09X

This manual provides detailed information to help the user understand status transaction processing in the file maintenance program. It describes processing for executing termination status transactions on a process (action) and a quote basis. A program abstract, narratives, and flowcharts are provided. (32 pages)

GH20-0660 Advanced Life Information 60
System File Maintenance Status
Transactions-Process and Quote
Miscellaneous, Loan Values, and
Participation Values System Manual

Program Number: 360A-IL-09X

This manual provides detailed information to help the user understand status transaction processing in the file maintenance program. It describes processing for executing miscellaneous, loan value, and participation value status transactions on a process (action) and a quote basis. A program abstract, narratives, and flowcharts are provided. (76 pages)

GH20-0661 Advanced Life Information 60
System File Maintenance Billing
Transactions System Manual

Program Number: 360A-IL-09X

This manual provides detailed information to help the user understand the billing processing in the file maintenance program. It describes processing

for the internal transaction billing (normal billing), catch-up billing, externally generated billing (billing request transaction billing), and special frequency billing. A program abstract, narratives, and flowcharts are provided. (56 pages)

GH20-0662 Advanced Life Information 60
System File Maintenance Premium Due,
Overdue, and Anniversary Processing
Transactions System Manual

Program Number: 360A-IL-09X

This manual provides detailed information to help the user understand the internal activity processing in the file maintenance program. It describes processing for premium due, overdue, and anniversary processing activity. A program abstract, narratives, and flowcharts are provided. (56 pages)

GH20-0663 Advanced Life Information 60
System File Maintenance Rate File
Extract and Anniversary Extract Up-
date Transactions System Manual

Program Number: 360A-IL-09X

This manual provides detailed information to help the user understand the creation of rate file extracts and the anniversary extract update processing in the file maintenance program. It describes processing for the creation of the rate file extracts and the processing required to perform the anniversary extract updating. A program abstract, narratives, and flowcharts are provided. (24 pages)

GH20-0664 Advanced Life Information 60
System File Maintenance Contractual
Changes and Notifications System
Manual

Program Number: 360A-IL-09X

This manual provides detailed information to help the user understand the internal activity processing in file maintenance. It describes the internal processing based on the annual activity and contractual change activity date in the policy information section of the policy master record. A program abstract, narratives, and flowcharts are provided. (104 pages)

GH20-0665 Advanced Life Information 60
System Output Analysis Program Sys-
tem Manual

Program Number: 360A-IL-09X

This manual provides detailed information to help the user understand program logic. It describes the processing of messages output from file maintenance run. Appropriate flowcharts, flowchart narratives, input/output formats, program modification aids, and tables and descriptions are included. The input/output formats and descriptions are to be used as an explanation of the file maintenance output in addition to their use to describe the input and output from the output analysis program. (212 pages)

GH20-0666 Advanced Life Information 60
System Transaction Register Program
System Manual

Program Number: 360A-IL-09X

This manual provides detailed information to help the user understand program logic. It describes processing of transaction register extracts and error register extracts produced by the output analysis program and also describes the creation of transaction register reports. Appropriate flowcharts, flowchart narratives, input/output formats, tables and descriptions, and program modification aids are included. (84 pages)

GH20-0667 Advanced Life Information 60
System Status Print Program System
Manual

Program Number: 360A-IL-09X

This manual provides detailed information to help the user understand program logic. It describes processing for rate file extracts, the reference to the rate file, and the creation of the output extract for updating the policy master record file. Appropriate flowcharts, flowchart narratives, input/output formats, and program modification aids are included. (40 pages)

GH20-0668 Advanced Life Information 60
System Policy Accounting Journal
System Manual

Program Number: 360A-IL-09X

This manual provides detailed information to help the user understand program logic. It describes the processing of accounting messages and the printing of the policy accounting journal. Appropriate flowcharts, flowchart narratives, input/output formats, and tables are included. (32 pages)

GH20-0669 Advanced Life Information 60
System Accounting Control Program
System Manual

Program Number: 360A-IL-09X

This manual provides detailed information to help the user understand program logic. It describes the updating of the accounting control file and the printing of the accounting control register. Appropriate flowcharts, flowchart narratives, input/output formats, and program modification aids are included. (52 pages)

GH20-0670 Advanced Life Information 60
System Error Register Program System
Manual

Program Number: 360A-IL-09X

This manual provides detailed information to help the user understand program logic. It describes the processing of error register messages and the printing of the error register. Appropriate flowcharts, flowchart narratives, input/output formats, and tables and descriptions are included. (32 pages)

GH20-0671 Advanced Life Information 60
System Rate File Program System
Manual

Program Number: 360A-IL-09X

This manual provides detailed information to help the user understand program logic. It describes processing of status report extracts produced by the output analysis program and the creation of printed status reports. Appropriate flowcharts, flowchart narratives, input/output formats, tables and descriptions, and program modification aids are included. (212 pages)

GH20-0672 Advanced Life Information 60
System Home Office Inquiry Program
System Manual

Program Number: 360A-IL-09X

This manual provides detailed information to help the user understand the home office inquiry program. A program abstract, narratives, flowcharts, core storage map, and program modification aids are provided. (52 pages)

GH20-0678 Graphic Analysis of 65
Three-Dimensional Data (GATD):
Program Description Manual

Program Number: 5734-XX2

Graphic Analysis of Three-Dimensional Data (GATD) is an application system built around the IBM 2250 Display Unit, which permits online analysis of data in three-dimensional arrays. GATD operates in conjunction with OS/360, PLAN (Problem Language ANalyzer), and PGS (PLAN Graphic Support).

This manual contains a general description of the GATD system, an example of system usage, detailed information on preparation of user data for GATD processing, and GATD file descriptions. It also contains, for each function performed by the GATD system, a description of the function, restrictions and range, and a description of all displays and programs used to implement the function. (120 pages)

SH20-0679 Graphic Analysis of 65
Three-Dimensional Data (GATD):
Operations Manual

Program Number: 5734-XX2

Graphic Analysis of Three-Dimensional Data (GATD) is an IBM 2250-oriented application program which operates under OS/360 and uses facilities of the Problem Language ANalyzer (PLAN) and PLAN Graphics Support (PGS) packages.

This manual describes the Job Control Language and PLAN statements required to retrieve machine-readable material from the distributed tape, perform all one-time initialization functions, and execute a sample problem. It also describes modifications to Job Control Language and PLAN statements for subsequent runs involving addition of user programs to the library, addition of user

panels, access to user input and output data files, and saving and restoring data generated by the GATD programs. Included are all considerations necessary to display the main GATD control panel on an IBM 2250 Display unit. All subsequent considerations involved in using the system, including error messages displayed and associated error recovery procedures, are included in the Terminal Operations Manual. (32 pages)

SH20-0680 Graphic Analysis of Three- 65
Dimensional Data (GATD): Terminal
Operations Manual

Program Number: 5734-XX2

This manual is written for the IBM 2250 console operator and describes how the light pen is used to control the GATD system. (64 pages)

SH20-0688 1130 Charge Materials 65
Allocation Processor (1130 CMAP):
Operations Manual

Program Number: 5711-P11

This program provides the IBM 1130 user with a means of calculating the least-cost initial charge of materials to be melted to specified metallurgical and weight limits. The Charge Materials Allocation Processor uses a linear programming technique to solve the problem—the processor selects an initial charge of materials from an inventory of available items in order to minimize the total cost of the initial charge.

Since all potential users of the Charge Materials Allocation Processor may not be familiar with linear programming techniques, an input translator is designed to accept data in a format familiar to the user. An output writer presents the solution in reports designed for easy interpretation by the user. The program operates under control of the 1130 Disk Monitor System, Version 2, and utilizes the facilities of the Linear Programming System/1130 (LPS/1130) to provide the user with a powerful problem-solving tool.

This manual contains instructions for generating a CMAP system and for running 1130 CMAP. Halts and messages are explained. (68 pages)

SH20-0692 General Purpose Simulation 65
System/360 OS Version 2
Operator's Manual

Program Number: 5734-XS1

This publication contains information that will enable the user to link-edit and incorporate the GPSS/360 program into a system for subsequent execution under the control of OS/360. Detailed examples are given for editing the GPSS/360 program into a private JOBLIB or the OS/360 SYS1. LINKLIB; several other examples illustrate the OS/360 JCL cards required to execute models that use various features provided by GPSS/360.

This Operator's Manual describes and illustrates a method (REALLOCATION) whereby the user can reallocate the quantity of GPSS/360 entities and effectively use all available core storage. The various data sets required by GPSS/360 are also listed and described.

This manual explains in detail three extended features of GPSS/360. It also includes specifications and considerations for use of the Run Length feature and the LOAD feature, as well as examples of independently compiled user-written FORTRAN routines used in conjunction with GPSS/360. (68 pages)

SH20-0693 General Purpose Simulation 65
System/360 OS Version 2
Introductory User's Manual

Program Number: 5734-XS1

This publication provides a basic introduction to the use of the General Purpose Simulation System/360 (GPSS/360). It is written for those individuals who have not had previous simulation experience

Examples are given throughout the manual to emphasize the basic features of the GPSS/360 program. A complete and detailed description of all the GPSS/360 features may be found in the GPSS/360 User's Manual (H20-0694). Readers are advised to obtain a copy of the User's Manual when they begin to write more sophisticated models.

The information presented in this manual should enable most readers to apply the program intelligently within a short period of time. (92 pages)

SH20-0694 General Purpose Simulation 65
System/360 OS and DOS Version 2
User's Manual

Program Numbers: 5734-XS1
5736-XS1

This publication is an extension and amplification of the GPSS/360 Introductory User's Manual (SH20-0693). It provides a detailed description and explanation of the component parts and operation of the GPSS/360 program. Examples illustrating the uses of GPSS/360 are given in appropriate sections of the manual. This manual should enable the reader to construct and simulate models using the full capabilities of GPSS/360. (264 pages)

GH20-0697 Medical Information System 60
Programs (MISP)—Application
Description Programmer's Manual

Program Number: 360A-UH-08L

The purpose of this manual is to describe how to use the Medical Information System Programs and facilities. A description of each interface to the executive program, each library routine, system symbols, and parameters for system definition are included. In addition, there is a series of steps outlined for guidance in construction of application programs using the MISP facilities.

This manual is available to those who meet the special conditions under which MISP is released. (204 pages)

SH20-0698-0 General Purpose 65
Simulation System/360 DOS,
Version 2, Operation Manual

Program Number: 5736-XS1

This publication contains information that will enable the user to link-edit and incorporate the GPSS/360 program into a system for subsequent execution under the control of DOS-360.

A method (REALLOCATION) whereby the user can reallocate the quantity of GPSS/360 entities and effectively use all available core storage is described and illustrated. The various data sets required by GPSS/360 are also listed and described.

Three extended features of GPSS/360 are explained in detail in this publication. Specifications and considerations for use of the Run Length feature, the LOAD feature, and examples of independently compiled user-written FORTRAN routines used in conjunction with GPSS/360 are also included. (68 pages)

SH20-0702 Communications Network 70
Design Program/360 (CNDP/360)
Program Description and Operations
Manual

CNDP/360 is a program that assists in the design of communication networks used for data and message transmission. It is designed to run on System/360 under control of the Disk Operating System or the Tape Operating System. The program is available as part of a Special Installation Services Offering that provides communication network design capabilities.

This manual describes the design capabilities of CNDP/360 input information and program output. A sample run is provided to illustrate the required design data and network constructed. Also included are the necessary operating instructions. (120 pages)

GH20-0710 CALL/360-OS FORTRAN 60
Language: Reference Manual

Program Number: 360A-CX-42X

CALL/360-OS is a system designed to operate under Operating System/360 (OS/360). It provides the facility (tool) of personal computing for a user at a remote terminal. CALL/360-OS is applicable for a wide range of users, including those users with little or no computer experience, as well as experienced programmers. It consists of a Terminal Command Language, plus language processors, and it emphasizes problem solution at the convenience of the terminal user. Thus, a terminal user will be provided with improved turnaround, ease of use, and increased availability of the computer resources.

This manual provides a description of the features available in the CALL/360-OS FORTRAN language. (92 pages)

SH20-0711 System/360 Text Processor— 65
EDIT/360: Operations Manual

Program Product: 5736-K11

The EDIT/360 component of the IBM System/360 Text Processor consists of control and functional

routines which retrieve input from a user-prepared disk-resident file. Input consists of textual material, text-formatting commands, and output requests. After the output text has been proofread, alterations can be made to stored textual data through the use of text modification commands without reentering the original text input. Completely justified and corrected text is written as generalized disk records. The user must provide routines to retrieve this generalized information, convert it into coding acceptable to the specific composition device on which final printing will occur, and write it to the appropriate systems output device. If word division capabilities are required, EDIT/360 uses the HYPHENATION/360 component of the System/360 Text Processor (360A-DP-07X).

This publication contains detailed preparatory systems procedures; operating instructions, error messages, and restart procedures for the component programs; and programming system and machine requirements.

A detailed knowledge of DOS operating procedures is a prerequisite for reading and using this manual. (140 pages)

SH20-0712 System/360 Text Processor— 65
EDIT/360: Program Description
Manual

Program Product: 5736-K11

The EDIT/360 component of the IBM System/360 Text Processor consists of control and functional routines which retrieve input from a user-prepared disk-resident file. Input consists of textual material, text-formatting commands, and output requests. After the output text has been proofread, alterations can be made to stored textual data through the use of text modification commands without reentering the original text input. Completely justified and corrected text is written as generalized disk records. The user must provide routines to retrieve this generalized information, convert it into coding acceptable to the specific composition device on which final printing will occur, and write it to the appropriate systems output device. If word division capabilities are required, EDIT/360 uses the HYPHENATION/360 component of the System/360 Text Processor (360A-DP-07X).

This publication contains an explanation of the composition control languages supported processing and file descriptions, system and machine requirements, timing information, examples, and preinstallation requirements for use of the EDIT/360 module and its associated utility programs. A detailed knowledge of DOS operating procedures is a prerequisite for reading and using this manual. (320 pages)

GH20-0719 IBM System/360 61
DOS Power II
Application Description Manual

This is a general introduction to POWER II (Priority Output Writers, Execution Processors, and Input Readers), and automatic SPOOLing processor and priority scheduler for normal batch

processing under DOS. POWER II operates under DOS, providing significant improvement in system throughput, and many additional functions. (28 pages)

GH20-0720-0 Coursewriter III for 60
System/360
Version 2 Operator's Guide

Program Number: 360A-UX-01X

This publication describes operations to be performed by the Coursewriter III System console operator. These include:

1. A brief section on system components with a sample machine configuration.
 2. A detailed step-by-step procedure to prepare the Coursewriter III, Version 2, System.
 3. IBM terminal line code and EBCDIC tables.
- Prior knowledge of Disk Operating System/360 and Basic Telecommunication Access Method operating procedures is assumed. (27 pages)

GH20-0721 Consumer Goods 65
System (COGS)—Allocation
Application Description Manual

Program Number: 5736-D31

This manual describes a technique called variable interval allocation as it applies to the distribution function of the consumer goods industry. Consumer Goods System (COGS)—Allocation handles allocation of finished products to warehouses or distribution centers on the basis of forecast usage, current stock status, shipping restrictions, and management's policy for service and inventory. COGS—Allocation also provides a means of simulating the distribution process for up to one year.

The audience for this manual includes executives, system analysts, and programmers. The manual provides an overview of the application with information for the prospective customer to use in determining applicability and begin planning for implementation of the program. Included in the manual are a general description of the program, common elements of the push and pull policies, elements unique to a pull policy, elements unique to a push policy, user responsibilities, system considerations, and input/output formats. (28 pages)

GH20-0722 Consumer Goods System 65
(COGS)—Forecasting
Application Description Manual

Program Number: 5736-D32

The system embodies a statistical forecasting technique that should be useful to firms in the food, pharmaceutical, soap, and cosmetic industries.

The audience for this manual includes executives, system analysts, and programmers. The manual provides an overview of the application with information for the prospective customer to use in determining applicability and begin planning for implementation of the program. Included in the manual are forecasting concepts and methods used in the program, general description of the application, module functional descriptions,

forecasting system flow diagram, input/output file description, control and audit procedures, program precision and restrictions, and customer responsibilities. (56 pages)

GH20-0723 DATA/360-DOS 65
Application Description Manual
Preliminary Version

Program Number: 5736-XS2

DATA/360 is a teleprocessing program written in Assembler Language to operate under the Disk Operating System (DOS). Its purpose is to provide a method of entering data by means of 24 local 2260 Display Station Model 2 terminals to a 2314 Direct Access Storage Facility and of verifying this data to produce input to a user's program, bypassing all unit record operations. (28 pages)

GH20-0725 Advanced Multiprogramming 70
Analysis Procedure (AMAP)
Service Description Manual

An IBM Special Installation Service, AMAP is used by systems engineers to analyze the customer's system in order to improve its performance.

This manual briefly describes AMAP and the customer's responsibilities when using the AMAP service. Included are descriptions of the AMAP programs and guidelines to plan for the use of the AMAP service. (32 pages)

SH20-0726 System/360 Order 65
Allocation System Program
Description Manual

Program Number: 5736-D41

The Order Allocation System is designed to assist apparel manufacturers in allocating available inventory to open orders in a manner consistent with management objectives and direction.

Input to the system consists of the user's order and inventory files and the rules to be followed in performing the allocation function. Output from the system consists of picking documents and updated order and inventory files, as well as various listings, reports, and control totals.

This manual describes the programs in the system and provides guidance for the installation and use of the Order Allocation System. The reader should be familiar with the Application Description Manual for the Order Allocation System (H20-0604). (228 pages)

SH20-0727 DATA/360-DOS 65
Console Operator's Guide
Preliminary Version

Program Number: 5736-XS2

This manual presents (1) a procedure for initializing the DATA/360 system, (2) a description of DATA/360 utilities and procedures for using them, and (3) a complete and detailed description of all files and their associated formats. (40 pages)

SH20-0728 Order Allocation System 65
Operations Manual

Program Number: 5736-D41

The Order Allocation System Assists apparel and shoe manufacturers in allocating and shipping stock to customers. This manual describes the operating procedures and job control cards required for retrieving programs from the distribution tape, preparing the system, operating the system, and running the sample problem. (64 pages)

SH20-0729 DATA/360-DOS 65
Terminal Operator's Guide
Preliminary Version

Program Number: 5736-XS2

This manual describes the entire command structure for DATA/360. Each command (both primary and secondary) is explained in sufficient detail to enable an experienced keypunch operator to quickly acquire the skills necessary to exploit the advantages offered by the DATA/360 system. This manual is organized to facilitate teaching of inexperienced operators as well as to serve as a reference guide. (24 pages)

GH20-0735 Coursewriter III for 65
System/360 (OS and DOS)
Version 2
Application Description Manual

Program Number: 5734-E12

This publication describes the Coursewriter III System developed for System/360. Included are comments on the value, range, and capabilities of computer-assisted instruction systems in general, as well as descriptive material relating to the computing equipment and programming systems used by System/360. (52 pages)

SH20-0736 System/360 Generalized 65
Information System (Basic)
System/360 Generalized Information
System
Program Description Manual
Volume III: Procedural Language

Program Number: 5736-CX1

This manual describes procedural language facilities for specifying file-processing tasks to be performed by the program product—short title GIS and GIS (Basic)—under the overall control of the System/360 Operating System.

Procedural language statements provide for interrogating, modifying, and updating data files previously defined by means of the GIS data description language. Input statements use English keywords and extension words, and common arithmetic symbols, to express the system user's procedural logic.

All elements of the procedural language, and all task statement formats are identical for both GIS and for GIS (Basic). Examples and appendix entries show how procedural language elements combine to form statements, and how the statements appear in a task specification. (288 pages)

GH20-0737 IBM System/360 61
DOS Power II
Program Description and Operations Manual

Program Number: 360D-05.2.006

POWER II (Priority Output Writers, Execution Processors, and Input Readers) is an automatic SPOOLing processor and priority scheduler for normal batch processing under IBM System/360 Disk Operating System. This manual describes the general concepts and facilities of POWER II. It includes operational and functional characteristics, installation procedures, and maintenance and performance guidelines. (124 pages)

GH20-0746 System/360 DOS LEARN 65
Administrative Terminal System
Application Description Manual

DOS LEARN Administrative Terminal System is designed to help ATS/DOS installations teach their terminal operators to use the System/360 Administrative Terminal System. It consists of new and replacement macros and application programs to be incorporated into the existing ATS and eight lessons to be stored as ATS permanent storage documents.

This publication contains a general discussion of the features of the product and the application for which it is designed. (16 pages)

GH20-0751 OS/360 Requirements 65
Planning Application Description Manual

Program Number: 5734-M51

A manufacturing organization requires that all parts, both manufactured and purchased, be available to meet production schedules demanded by finished product due dates, and that a sufficient quantity be available to satisfy demand. Manufacturing also must be able to adjust these requirements quickly to react suitably and in time to forecast any customer order changes. In addition, there is a need to maintain inventories at an optimum level so as not to incur the costs of obsolescence, unneeded warehouse space, unnecessary inventory, insurance, and purchase charges. OS/360 Requirements Planning is designed to satisfy these requirements and needs. The system is capable of:

- Determining net finished product requirements
- Determining net component part requirements
- Planning economic lot size or order quantities
- Offsetting requirements by considering lead times
- Maintaining and updating the requirements plan by processing changes to forecasts and orders (referred to as "requirements alterations")
- Providing for review of planned orders at the end of each level; interrupt and adjustment of these planned orders; reentry (referred to as "planned order adjustment")
- Providing for management review through detailed requirements reports and exception notices

The audience for this manual includes customer executives, systems analysts, and programmers. The manual contains information necessary for the

potential user to determine applicability and to begin planning for implementation of the system. (112 pages)

**GH20-0752 OS/360 Inventory Control 65
Application Description Manual**

Program Number: 5734-M52

The IBM OS/360 Inventory Control program product consists of a group of integrated programs and techniques designed for the selection and implementation of order point inventory control where it applies in manufacturing organizations.

The programs provide for (1) classification of inventory items for determining the type of control, (2) calculation of economic order quantities on the basis of usage information or future requirements, (3) computation of safety stock and order point, and (4) projection of demand on the basis of historical data.

This manual gives information for determining the applicability of the programs, and includes a general description of the programs, the machine configuration, general systems charts, sample reports, and a discussion of inventory control concepts applicable to the use of the programs. The audience for this manual includes customer executives, systems analysts, and programmers.

**GH20-0753 System/360 Shop Floor 65
Control Application Description
Manual**

Program Number: 5736-M31

The System/360 Shop Floor Control System is designed to provide substantial information about the status of orders moving through manufacturing facilities so that proper control can be maintained throughout the production cycle. To accomplish this, System/360 Shop Floor Control performs the following:

- Determines when orders should be released
- Prepares exception notices when material for an order is not available
- Creates files containing open order information
- Prepares data for output to shop and management personnel
- Provides retrieval of pertinent files for the user to update upon receipt of information from the shop floor
- Provides retrieval report capability pertaining to the status of orders in the shop
- Provides the priority calculation and preparation of a work list in priority sequence

System/360 Shop Floor Control is designed to provide current information about production orders and facilities, thereby providing management the ability to exert the proper control over shop floor activity. This control is attainable by determining the orders to be released to the shop, creating and maintaining records pertaining to these orders, and quickly accessing report information.

This manual describes System/360 Shop Floor Control and provides information to enable the reader to determine applicability and to begin planning for the program product. The audience includes executives, systems analysts, and programmers. (60 pages)

**GH20-0754 System/360 Shop Floor 65
Control Data Base Manual**

Program Number: 5736-M31

This manual describes the data base records and fields that are used by the System/360 Shop Floor Control program product. The following records are included:

- Item master subordinate item master
- Product structure
- Work center master
- Standard routing
- Open order summary
- Open order detail

A separate section of this manual shows the other IBM application programs and program products that use the same files. The following IBM programs are referenced:

- System/360 Bill of Material Processor
- System/360 Inventory Control
- System/360 Requirements Planning
- System/360 Capacity Planning
- System/360 Shop Floor Control

This publication is intended to assist the user's system personnel in the planning of data base requirements for program product System/360 Shop Floor Control. (40 pages)

**GH20-0757 Conversational 61
Programming System
(CPS) System Programmer's Guide**

Program Number: 360D-03.4-016

This publication provides information and descriptions of internal functions of the Conversational Programming System (CPS). In internal logic and flow is described, and individual program module descriptions are given. The reader is assumed to be thoroughly familiar with the externals of the Conversational Programming System, as presented in the Terminal User's Manual.

**GH20-0758 Conversational 61
Programming System
(CPS) Terminal User's Manual**

Program Number: 360D-03.4-016

This publication provides the rules and procedures to be followed for using the Conversational Programming System (CPS), a time-sharing system that runs in a partition of the IBM System/360 Operating System MFT II or MVT. It is a reference manual for all of the statements and commands of the fifth release of the system, which includes conversational dialects of PL/I and Basic and Remote Job Entry to batch processing. (212 pages)

**GH20-0763 System/360 Financial 65
Terminal System Application
Description Manual**

Program Number: 5736-F12

Financial Terminal System (FTS) is a System/360 DOS processing program designed to facilitate implementation of a fast-response, telecommunications system. FTS acts as the controller of a BTAM partition, coordinating the DOS Multitasking Supervisor with a communications network.

The FTS user invokes FTS services and resources to assist his application-oriented processing through the medium of the DOS Assembler Language macro facilities. (40 pages)

**GH20-0764 System/360 Agribusiness 65
Management Information System
Application Description Manual**

Program Number: 5736-D51

The Agribusiness Management Information System (AMIS) provides a computer-oriented cost accounting system for farmers, ranchers, and growers. A distinguishing feature is the emphasis this system places on management accounting by cost center. At the same time, the system produces financial accounting records necessary for fiscal control. The system represents a significant step in organizing and presenting the information needed for sound management decisions.

This manual contains a general description of the system and the systems approach taken. It is intended to introduce the reader to the system and to serve as a guide for early planning. (58 pages)

**GH20-0765 Information Manage- 65
ment System/360 for the IBM
System/360 (System Description)
Version 2 General Information
Manual**

Program Number: 5794-XX6

The Information Management System/360 is an Operating System/360 processing program designed to facilitate the implementation of medium to large common data bases in a multiapplication environment. This environment is created to accommodate both online message processing and conventional batch processing, either separately or concurrently. The system permits the evolutionary expansion of data processing applications from a batch-only to a teleprocessing environment.

This manual includes a general description of the system and its various facilities and programs, listings of typical and minimum configurations, and sample applications. (80 pages)

**SH20-0766 IBM System/360 65
OS LEARN Administrative
Terminal System
Program Description Manual**

Program Number: 5734-XX8

This program is used to assist ATS/OS installations in teaching their terminal operators to use the System/360 Administrative Terminal System. It functions under ATS by incorporating additional and modified macros and application programs into the existing system.

This manual contains the instructions necessary for the installation and maintenance of LEARN ATS under ATS/OS. It also contains information on the functions and commands of the program and may be used as a reference manual. (20 pages)

SH20-0767 IBM System/360 65
DOS LEARN Administrative
Terminal System
Program Description Manual

Program Number: 5736-XX3

This program is used to assist ATS/DOS installations in teaching their terminal operators to use the System/360 Administrative Terminal System. It functions under ATS by incorporating additional and modified macros and application programs into the existing system.

This manual contains the instructions necessary for the installation and maintenance of LEARN ATS under ATS/DOS. It contains information on the functions and commands of the program and may be used as a reference manual. (20 pages)

SH20-0768 IBM System/360 65
LEARN Administrative
Terminal System Workbook

Program Nos.:

5734-XX8

5736-XX3

The workbook is intended as a complement to the LEARN ATS package. It introduces ATS and LEARN ATS to the student and guides her through the procedures required to sign on ATS and begin taking LEARN ATS, which consists of seven lessons aimed at providing the basics of ATS/360 operations from a terminal standpoint.

Appendices contain illustrative material for the lessons. (56 pages)

SH20-0769 Shared Laboratory 65
Information System (SLIS)
Laboratory Manual

Program Number: 5736-H12

The IBM Shared Laboratory Information System (SLIS) provides data processing support for hospital clinical laboratories. Operating under the Shared Hospital Accounting System (SHAS) executive, the programs handle batched input of laboratory requisitions and test results, producing laboratory reports for use throughout the hospital.

The program design allows tailoring of formats and procedures to meet the separate needs of several hospitals sharing a common computer. Input and output of the system may optionally use the SHAS teleprocessing executive, allowing remote data entry and report production. The laboratory application programs complement the SHAS accounting application programs through the use of a common admission procedure and automatic charge generation.

The basic publication provides specific information for installation planning and operation of the Shared Laboratory Information System. Detailed discussions cover available system options and user options, preparation of master file data, preparation of daily input to the system, and interpretation of output from the system.

This document should be used as a reference guide by both user-hospital personnel and central operations personnel during the entire life of the system.

Discussions in this manual pertain to the Shared Hospital Accounting System (SHAS) and the Automated Chemistry Program (ACP). For more detail on these systems, refer to *SHAS Program Description Manual* (GH20-0533), *SHAS Operations Manual* (GH20-0534), *ACP Application Description Manual* (GH20-0475), *ACP Program Description Manual* (GH20-0515), and *ACP Operations Manual* (GH20-0516).

GH20-0771 System/360 Data Base 65
Organization and Maintenance
Processor Application Description
Manual

Program Number: 5736-XX4

The System/360 Data Base Organization and Maintenance Processor is a programming system designed to create, maintain, and reorganize the central data base in a multiapplication environment. It provides the framework for a computer-oriented information system. Primarily batch-oriented, the system operates under DOS/360.

This manual provides an overview of the system, specifies the functions, options, and features included in the system, and provides information necessary to begin planning for implementation. The content includes a description of the data structure facilities of the system, system flowcharts, a description of the programs in the system, machine configuration requirements, performance estimates, and user responsibilities for implementation. The manual is data processing-oriented with a variety of application examples. The primary audience is intended to be data processing executives, systems analysts, and programmers.

This program is a modified and extended version of the IBM System/360 Bill of Material Processor. Appendix A contains a discussion of this application. Appendix B of this manual enumerates the improvements and conversion considerations. (76 pages)

SH20-0776 OS/360 Inventory 65
Control Program Description Manual

Program Number: 5734-M52

The OS/360 Inventory Control program product consists of a group of integrated programs and techniques designed for the implementation of order point inventory control where it applies in manufacturing organizations.

The programs provide for (1) analysis and classification of inventory items, (2) calculation of economic order quantities on the basis of usage information or future requirements, (3) computation of safety stock and order point, and (4) projection of demand on the basis of historical data.

This manual enables the user to understand the functions of, prepare for, and install the program product. Included are descriptions of the programs and the processing, definitions of input, output, and files; a discussion of the program options, program macros, and program input/output; and tables and formulas utilized within the programs. The audience for this manual includes systems analysts and programmers. (200 pages)

SH20-0777 OS/360 Requirements 65
Planning Program Description Manual

Program Number: 5734-M51

OS/360 Requirements Planning determines planned orders by time period for finished products, assemblies, subassemblies, parts, and raw materials based upon the input of orders and forecasts. OS/360 Requirements Planning consists of three components, the requirements generation program, the print exception program, and the chained file management system.

The chained file management system creates and maintains the direct access files, consisting of the item master, product structure, work center master, and routing files, used by a central manufacturing system. The chained file management system is required by, and is provided with, the OS/360 Requirements Planning program product.

This manual includes (1) discussions of system definition, (2) descriptions of all input/output files, (3) a detailed description of the requirements generation program, (4) a detailed description of the print exception program, (5) a detailed description of the chained file management system program modules, (6) a detailed description of customizing procedures to generate various chained file management system program modules, (7) a detailed description of customizing procedures to generate the requirements generation and print exception programs, and (8) information regarding the two sample problems. (416 pages)

SH20-0778 OS/360 Inventory 65
Control Operations Manual

Program Number: 5734-M52

OS/360 Inventory Control consists of seven programs designed to assist in the implementation of order point inventory control in manufacturing organizations.

This manual contains information regarding preparatory and operating procedures for the programs. It includes a complete list of the messages that can be produced by the programs. (36 pages)

SH20-0780 Shared Laboratory Infor- 65
mation System (SLIS) Program
Description Manual

Program Number: 5736-H12

The IBM Shared Laboratory Information System (SLIS) provides data processing support for hospital clinical laboratories. Operating under the Shared Hospital Accounting System (SHAS) executive, the programs handle batched input of laboratory requisitions and test results, producing laboratory reports for use throughout the hospital.

The program design allows tailoring of formats and procedures to meet the separate needs of several hospitals sharing a common computer. Input and output of the system may use the SHAS teleprocessing executive, allowing remote data entry and report production. The laboratory application programs complement the SHAS accounting application programs through the use of a common admission procedure and automatic charge generation.

This basic publication provides information on the Shared Laboratory Information System, enabling the user to understand the function of all SLIS programs as a guide for preparing to install SLIS. This document is written as a reference manual and not as a study text. For educational purposes this manual should be used in conjunction with the SLIS Application Description Manual (GH20-0709). The SLIS Operations Manual (SH20-0781), and the SLIS Laboratory Manual (SH20-0769). (120 pages)

SH20-0781 Shared Laboratory Information System (SLIS) Operations Manual 65

Program Number: 5736-H12

The IBM Shared Laboratory Information System (SLIS) provides data processing support for hospital clinical laboratories. Operating under the Shared Hospital Accounting System (SHAS) executive, the programs handle batched input of laboratory requisitions and test results, producing laboratory reports for use throughout the hospital.

The program design allows tailoring of formats and procedures to meet the separate needs of separate hospitals sharing a common computer. As an option, the system may use the SHAS teleprocessing executive for input and output, allowing remote data entry and report production. The laboratory application programs complement the SHAS accounting application programs through the use of a common admission procedure and automatic charge generation.

This basic publication gives the necessary information for operating the SLIS programs. It includes a description of retrieving data from distributed machine-readable material and cataloging programs in the user's core image library. Use of this manual requires an operating knowledge of the IBM Disk Operating System (DOS) job control cards and operating procedures.

This document is written as a reference manual for central operation personnel. For educational purposes, it should be used in conjunction with the SLIS *Application Description Manual* (GH20-0709), and the SLIS *Program Description Manual* (SH20-0780).

User-hospital personnel will find guidance for data creation and coding in preparation for installation and information on options available during operation in the SLIS Laboratory Manual (SH20-0769). (136 pages)

SH20-0782 OS/360 Requirements Planning Operations Manual 65

Program Number: 5734-M51

OS/360 Requirements Planning consists of three components: the requirements generation program, the print exception program, and the chained file management system.

OS/360 Requirements Planning offers a mechanized approach to detailed requirements planning. It uses item master and product structure files created and maintained by the chained file management system.

This manual contains information regarding preparatory and operating procedures for the programs. It includes a complete list of system messages that can be generated by the programs. (56 pages)

GH20-0785 System/360 Scientific Procedure Library/Mathematics PL/I Application Description Manual 65

Program Number: 5743-XM3

The System/360 Scientific Procedure Library/Mathematics - PL/I (SPL/MATH-PL/I) is a collection of mathematical procedures written in the PL/I language. It consists of input/output-free computational building blocks, written completely in PL/I, which may be combined with a user's input, or computational routines as needed. The procedures in this library may be applied to the solution of many problems in industry, science, and engineering.

This manual presents an introduction to SPL/MATH-PL/I, a list of the capabilities of the library, rules of usage, machine configuration, programming systems, and a list of reference material. (20 pages)

GH20-0786 CALL/360 - OS Executive and Utilities Program Description Manual 60

Program Number: 360A-CX-42X

This publication describes the facilities provided by CALL/360-OS to installation personnel who are responsible for the selection, evaluation, and implementation of the system. The audience aimed at includes systems engineers, installation programmers, marketing representatives, and customer systems personnel.

CALL/360-OS is a terminal-oriented, time-sharing system designed to function under the control of the IBM System/360 Operating System with either of two options: Multiprogramming with a Fixed Number of Tasks (MFT), or Multiprogramming with a Variable Number of Tasks (MVT). From the terminal user standpoint, the CALL/360-OS service environment approximates that of a dedicated, in-house, data processing installation.

Subjects discussed in this manual cover system concepts, executive and utility functions, data base management, system installation, run-time options, and diagnostic aids. Error messages available to the user system are described in a separate manual: CALL/360-OS, Operator's Manual (GH20-0788). (168 pages)

GH20-0787 CALL/360-OS Terminal Operations Manual 60

Program Number: 360A-CX-42X

This manual discusses those elements of terminal characteristics, operations, and maintenance pertaining to terminals used by the CALL/360-OS time-sharing system. It is addressed to the individual terminal user.

Additional operating techniques covering specific CALL/360-OS language statements, system commands, and terminal correction procedures can be found in the three separate language reference manuals: *CALL/360-OS BASIC Language Reference Manual* (GH20-0699) *CALL/360-OS FORTRAN Language Reference Manual* (GH20-0710), and *CALL/360-OS PL/I Language Reference Manual* (GH20-0700). (40 pages)

GH20-0788 CALL/360-OS Operator's Manual 60

Program Number: 360A-CX-42X

This publication describes the online operating procedures for the CALL/360-OS time-sharing system to computer center operator personnel responsible for day-to-day system operation.

CALL/360-OS is a terminal oriented, time-sharing system designed to function under the control of the IBM System/360 Operating System using either of the two available options: Multiprogramming with a Fixed Number of Tasks (MFT) or Multiprogramming with a Variable Number of Tasks (MVT).

Subjects discussed in this manual cover startup procedures and options, the Operator Command Language, shutdown and restart procedures, and runtime operating techniques. An entire section is devoted to a complete listing and explanation of all diagnostic messages available to the system user. A detailed description of CALL/360-OS facilities and capabilities is provided in a separate manual: *CALL/360-OS Executive and Utilities Program Description Manual* (GH20-0786). (76 pages)

GH20-0789 Brokerage Accounting System Elements (BASE) Application Description Manual 65

Program Number: 5736-F31

The Brokerage Accounting System Elements (BASE) program provides a comprehensive foundation for the back office data processing applications required by today's brokerage firm. The extensive series of application areas covered by BASE includes Purchase and Sale, Fails, Transfers, Stock Record, Dividends, Bookkeeping, Interest, Customer Statements, and others.

The BASE system is general enough to permit various options and modifications to suit the individual requirements of a particular brokerage firm. However, the processing in the application areas is so extensive that most programs will require little or no modification by the typical brokerage firm.

The integrity of the data as it flows through BASE is maintained by a series of balancing checks, tight control over the master files, and extensive input data editing before any transaction processing or file updating occurs.

Files containing pending items and master files are updated daily, producing over 75 reports encompassing the day's trade and related activity. Operating procedures are organized to allow a single job stream, with sorts and operator intervention kept to a minimum. (40 pages)

SH20-0790 System/360 Requirements Planning Interface Program Description Manual 65

Program Number: 5736-M13

The System/360 Requirements Planning Interface is a program product which, when added to System/360

Requirements Planning (360A-MF-05X), provides the ability to generate connection records. These connection records are required as input to System/360 Capacity Planning – Finite Loading (5736-M12). This manual includes information covering the functions and use of only this program product and must be used in conjunction with *System/360 Requirements Planning, Program Description Manual*, (GH20-0584). It is intended for use by systems analysts, programmers, and operational personnel. The user is presumed to have studied the following manuals:

- *System/360 Requirements Planning, Application Description Manual* (GH20-0487)
- *System/360 Requirements Planning, Program Description Manual* (GH20-0584)
- *System/360 Capacity Planning -- Finite Loading, Application Description Manual* (GH20-0627) (36 pages)

SH20-0791 System/360 Requirements Planning Interface Operations Manual 65

Program Number: 5736-M13

System/360 Requirements Planning Interface is a program product which, when added to System/360 Requirements Planning (360A-MF-05X) provides the ability to generate connection records. These connection records are required as input to System/360 Capacity Planning – Finite Loading (5736-M12). This Manual contains information regarding preparatory and operating procedures for only this program product. It must be used in conjunction with *System/360 Requirements Planning, Operations Manual* (GH20-0583).

The information in this manual is intended for systems analysts, programmers, and operating personnel, who are presumed to have studied the following manuals:

- *System/360 Requirements Planning, Application Description Manual* (GH20-0487)
- *System/360 Requirements Planning, Program Description Manual* (GH20-0584)
- *System/360 Requirements Planning, Operations Manual* (GH20-0583)
- *System/360 Capacity Planning -- Finite Loading, Application Description Manual* (GH20-0627)
- *System/360 Requirements Planning Interface, Program Description Manual* (SH20-0790) (16 pages)

SH20-0792 Tariff Publishing System (Bound Tariffs) Format and Standard Codes Manual 65

Program Number: 5736-T21

This manual contains information relating to the concepts, outputs, and processing functions provided by the Tariff Publishing System. It provides complete description of the system features including, formatting, editing, error correction, and maintenance controls.

Prerequisite information is contained in these publications:

1. Tariff Publishing System – Data Preparation Manual (SH20-0798)
2. Tariff Publishing System Program Description/Operations Manual (SH20-0812)

It is assumed that the reader of this manual is familiar with the information concerning formats and processing contained in these two publications. (144 pages)

SH20-0795 System/360 Capacity Planning/Infinite Loading System/360 Capacity Planning/Finite Loading Operations Manual 65

This manual includes: Customizing procedure for generating the System/360 Capacity Planning Programs, functional description of all programs. Description of all I/O files explanation and operating instructions for the sample problem. (48 pages)

SH20-0796 System/360 Capacity Planning—Infinite Loading System/360 Capacity Planning—Finite Loading Program Description Manual 65

Program Numbers:

5736-M11
5736-M12

System/360 Capacity Planning consists of a group of integrated programs and techniques designed to determine the capacity required to meet a production plan (infinite loading) and to determine the adjustments to a production plan based on available resources (finite loading).

The main application area is the job shop in which production facilities are used intermittently to perform production or assembly operations on different items. System/360 Capacity planning program product 5736-M12 includes the phases discussed below.

- The file creation and update phase reads and retains work center data and parameters on the system run file. It also creates a load file (production orders detailed by operations), and updates it according to the shop feedback if any.
- The infinite loading phase accumulates the load by work center and period without capacity restrictions.
- The connection (single-level pegging) phase determines the relationship of component orders to assembly orders and computes earliest start dates for each order and each operation, considering the planned availability of components.
- The finite loading phase loads to either the earliest or latest start date of production orders, considering the capacity restrictions and the planned availability of components.

Program product 5736-M11 consists of the file creation and update phase plus the infinite loading phase.

This manual includes:

- Customizing procedure for generating the System/360 Capacity Planning programs

- Functional description of all programs in the above phases
- Description of all I/O files
- Explanation and operating instructions for the sample problem

(208 pages)

SH20-0798 Tariff Publishing System (Bound Tariffs) Data Preparation Manual 65

Program Number: 5736-T21

This manual provides detailed information on the use of IBM 1050 Tariff Entry System. It is intended as a reference manual for all persons concerned with preparing tariff and profile entries and implementing all the functions of the system.

It contains sections on input specification format and code definitions, and sample presentations for each. (98 pages)

GH20-0802 Control Program – 67/ Cambridge Monitor System (CP-67/CMS) Version 3 System Description Manual 61

Program Number: 360D-05.2.005

Control Program-67/Cambridge Monitor System (CP-67/CMS) is a multi-access system which manages the resources of a System/360 Model 67 such that remote users appear to have a dedicated System/360 at their disposal. Within this 'virtual machine' the user may select the operating system of his choice, subject to certain restrictions noted in this manual. The Control Program (CP-67) component creates the time sharing environment in which many virtual 360s (users) can simultaneously access the system.

The Cambridge Monitor System (CMS) component is a conversational operation system used from a virtual machine, which provides a comprehensive, easy-to-use set of programs (commands) which give the CMS user a wide variety of functions, including the ability to create additional commands or subsystems to satisfy his special requirements.

This manual provides an overview of the features available in the CP-67/CMS System. (44 pages)

SH20-0803 Consumer Goods System (COGS) Forecasting Operations Manual 65

Program Number: 5736-D32

This publication provides the user with the information necessary to:

- Prepare to use the program
- Operate the program
- Retrieve and generate the program from the distribution tape
- Retrieve and run the sample problem

It is intended for operating personnel, systems analysts, and programmers. (48 pages)

- SH20-0804 System/360 Consumer Goods System (COGS) Forecasting Program Description Manual** 65
Program Number: 5736-D32
 The system embodies a statistical forecasting technique that should be useful to firms in the food, pharmaceutical, soap, and cosmetic industries as well as other industries having seasonal selling patterns.
 The objective of this manual is to provide the user with the information necessary to thoroughly understand the concepts and functions of COGS-Forecasting. Major topics covered in this manual are forecasting model selection and system implementation. After reading this manual, the user should be able to:
1. Understand the basic concepts of statistical forecasting and adaptive smoothing
 2. Select an appropriate forecasting model and its associated monitoring parameters
 3. Utilize the forecasting system as an integral part of a comprehensive inventory control system
- The audience for this manual includes operations research personnel, systems analysts, and programmers. This manual should be used in conjunction with the *COGS - Forecasting, Application Description Manual* (GH20-0722) and the *COGS - Forecasting, Operations Manual* (SH20-0803). (52 pages)
- SH20-0805 Medical Information Systems Program (MISP) Version 2 Operations Manual** 65
Program Number: 5736-H11
 The medical information Systems Program contains general executive modules, utilities, and user interfaces that provide the framework for a teleprocessing system using the Disk Operating System/360.
 This manual describes the procedures necessary for initial preparation and generation of the MISP programs, tables, and data sets; inclusion of the user data sets under MISP; operating procedures for the central system; and operation of the terminal devices that are part of a teleprocessing system running under MISP. (216 pages)
- GH20-0806 Medical Information Systems Program (MISP) Version 2 Application Description Manual** 65
Program Number: 5736-H11
 The Medical Information Systems Program (MISP) represents an application of information processing equipment to the development of information systems. MISP is designed to assist in the installation of a teleprocessing system with special facilities that make it particularly useful in a hospital and medical environment (hospital information system), linking the many different service areas in a hospital where complete and prompt patient care is a requirement.
 This manual describes in general the purpose and functions of MISP and its use in the implementation of a hospital information system. (56 pages)
- SH20-0807 Medical Information Systems Program (MISP) Version 2 - Installation Aid Manual** 68
 This manual includes various topics to aid the user in the installation of MISP. It is intended as a supplement to the *MISP Operations Manual*, (SH20-0805). (56 pages)
- SH20-0808 Medical Information Systems Program (MISP) Version 2 Program Description Manual** 65
Program Number: 5736-H11
 This manual contains detailed descriptions of the programs in MISP. The data sets and control blocks used by MISP programs are also described. (188 pages)
- SH20-0809 Medical Information Systems Program (MISP) Version 2 Programmer's Manual** 65
Program Number: 5736-H11
 The purpose of this manual is to describe how to use the Medical Information Systems Program and facilities. A description of each interface to the executive program, each library routine, system symbols, and parameters for system definition are included. In addition, a series of steps is outlined for guidance in construction of application programs using the MISP facilities. (192 pages)
- GH20-0810 IBM System/360 Filing and Source Data Entry Techniques for Easier Retrieval-Low Core (FASTER LC) Application Description** 65
Program Number: 5736-G22
 FASTER LC is a teleprocessing monitor for development and implementation of terminal-oriented systems. Terminals supported are 1050, 2740-1, 2260 Remote and 2260 Local. The FASTER LC system incorporates the capabilities to install inquiry, update, message routing and data entry applications. The system employs a set of macro instructions that generate the line control, interface, and message processing functions, thereby eliminating the need for detailed knowledge of terminal communications control or BTAM. This capability makes the FASTER LC system adaptable to a wide variety of applications. The system is designed to operate in a minimum 32K partition of a Model 2025 ED or larger System/360.
 The principle features are described, along with a discussion of the system design. Planning information is provided to assist in determining the applicability of FASTER LC to any particular operational environment. (48 pages)
- SH20-0811 Traffic Profile Analysis System Program Description and Operations Manual** 65
Program Number: 5736-T22
 The Traffic Profile Analysis System processes the magnetic tape tariffs produced by the Tariff Publishing System. Shippers and carriers may use the Traffic Profile Analysis System for computerized analysis of tariffs. Program facilities are provided to select tariff matter based on an interest profile.
 This manual provides the information necessary to understand the functions of the Traffic Profile Analysis System. Included is a general description of the programs, input/output description, processing description, timing information, programming systems and machine configuration, and a sample program.
 The Traffic Profile Analysis System is written in Assembler Language and operates under the IBM System/360 Disk Operating System. The Tariff Publishing System is a prerequisite for the use of the Traffic Profile Analysis System.
 The audience for this manual includes system analysis, programming, and operating personnel. (88 pages)
- SH20-0812 Tariff Publishing System (Bound Tariffs) Program Description and Operations Manual** 65
Program Number: 5736-T21
 The Tariff Publishing System is a computer program designed to assist the tariff publishing agent in supplementing, reissuing, and distributing bound tariffs. The principal outputs of the system are camera-ready tariff material for reproduction and magnetic tapes for computerized analysis of the tariffs.
 This manual provides the information necessary to understand the functions of the Tariff Publishing System. Included are a general description of the programs, input/output description, processing description, timing information, programming systems and machine configuration, and a sample problem.
 The Tariff Publishing System is written in Assembler Language and operates under the IBM System/360 Disk Operating Systems. The Tariff Publishing System is a prerequisite for the use of the Traffic Profile Analysis System.
 The audience for this manual includes system analysts, programmers and operating personnel. (72 pages)
- GH20-0813 CFO Autocoder to Assembler Language Instruction Set Translator (CATALIST) Application Description Manual** 65
Program Number: 5736-XX2
 The IBM CFO Autocoder to Assembler Language Instruction Set Translator (CATALIST) is a program designed to be used as a conversion aid for the transition from the IBM '62 CFO 1401 Autocoder programs to the IBM System/360. CATALIST attempts to greatly diminish the work associated with the most important transaction process—the job of producing System/360 versions

of existing 1401 programs. A single execution of the program translates a 1401 Autocoder source program into its System/360 Assembler Language equivalent.

This manual describes the IBM CFO Autocoder to Assembler Language Instruction Set Translator. Knowledge of DOS/360, 1401 Autocoder, and System/360 Assembler Language will assist the reader in understanding the contents. (16 pages)

SH20-0814 CFO Autocoder to Assembler Language Instruction Set Translator (CATALIST) Program Description and Operations Manual 65

Program Number: 5736-XX2

This manual contains information relating to the concepts, inputs, outputs, and processing methods used in the IBM CFO Autocoder to Assembler Language Instruction Set Translator (CATALIST). The manual provides the reader with (1) the information required to understand how CATALIST performs translation, (2) the information required to understand and respond to translation diagnostics, and (3) operating information required to set up and execute the CATALIST program.

Knowledge of DOS/360, 1401 Autocoder, and System/360 Assembler Language is required for complete understanding of the contents of this manual, whose audience includes systems analysts, programming personnel, and operating personnel. (64 pages)

SH20-0815 Medical Information Systems Program (MISP) Version 2 - Application File Description 65

Program Number: 5736-H11

This manual describes suggested data set designs for hospital application areas. In some cases, the organization of the data set may represent the fields and sequence in actual use, but the user is given the flexibility to create his own design as he chooses with the contents of this manual as guidance. (120 pages)

SH20-0820 System 360 Consumer Goods System (COGS) Allocation Operations Manual 65

Program Number: 5736-D31

This publication provides the user with information necessary to:

- Prepare to use the program
- Operate the Program
- Retrieve and generate the program from the distribution tape
- Retrieve and run the sample problem

The manual is intended for operating personnel, system analysts, and programmers. (32 pages)

SH20-0821 System/360 Consumer Goods System (COGS) Allocation Program Description Manual 65

Program Number: 5736-D31

The audience for this manual includes system analysts, programmers and some operating personnel. The manual provides information needed to prepare for and to install the program. In addition to a detailed description of the program, sections include the use of the program and the analysis of output. Input, processing, and output descriptions are supplemented with formulas and record formats. (100 pages)

GH20-0824 Introduction to the Real-Time Monitor (RTM) 60

The Real-Time Monitor (RTM) is an OS co-resident program that provides fast interrupt response for real-time, event-driven systems. Normal OS jobs continue to run in background mode while the monitor services real-time interrupts and schedules real-time jobs in priority mode. In addition, multiprogramming capability and OS facilities are provided for the real-time jobs. This manual presents the general design concepts of RTM and an over-view of those capabilities that enable the user to concurrently run real-time and batch jobs. It is assumed that the reader is familiar with standard OS terminology. (20 pages)

GH20-0825 General Purpose Simulation System V (OS) Application Description 65

This manual discusses the role of the General Purpose Simulation System (GPSS) in system simulation and is designed to help the reader determine its applicability. The manual also discusses the need for simulation, describes the scope and features of General Purpose Simulation System V, and gives some examples. It is addressed to customer executives and others responsible for evaluating new systems. (20 pages)

SH20-0827 System/360 Shop Floor Control Operations Manual 65

Program Number: 5736-M31

System/360 Shop Floor Control consists of planned order release, open order file maintenance, general information retrieval, and work list preparation, each of which contains one or more programs. This program product is designed to assist in the implementation of a shop floor control application in manufacturing organizations.

This manual contains information regarding preparatory and operating procedures for the programs. It includes a complete list of the error messages that can be produced by the programs. The audience for this manual includes customer operating personnel, systems analysts, and programmers. The prerequisite for the use of this manual is a knowledge of System/360 Disk Operating System and the Bill of Material Processor. (44 pages)

SH20-0828 System/360 Shop Floor Control Program Description 65

Program Number: 5736-M31

System/360 Shop Floor Control is a group of programs designed to provide current information about a manufacturing facility and to assist management in effectively controlling production. The programs provide for the release of orders to the manufacturing facility, the creation and maintenance of records pertaining to the orders, retrieval of orders, report capability on the status of the orders, and the preparation and printing of a work list for shop supervisory personnel.

This manual describes System/360 Shop Floor Control and provides information to enable the reader to install the program product. The audience includes system analysts, programmers, and certain operating personnel.

This manual includes (1) customizing procedures for generating the System/360 Shop Floor Control Programs, (2) a functional description of each program, (3) a description of all input/output files, and (4) an explanation of, and operating instructions for, the sample problem. (192 pages)

SH20-0829 System/360 Data Base Organization and Maintenance Processor Program Description Manual 65

Program Number 5736-XX4

The System/360 Data Base Organization and Maintenance Processor is a programming system designed to create, maintain, and reorganize the central data base in a multiapplication environment. It provides the framework for a computer-oriented information system. Primarily batch-oriented, the system operates under DOS/360.

This manual provides an overview of the system, specifies the functions, options, and features included in the system, and provides information necessary for implementation. The manual is data processing-oriented with a variety of application examples. The primary audience includes systems analysts and programmers.

This manual includes (1) a brief discussion of the system, (2) an implementation checklist, (3) descriptions of all I/O files, (4) an explanation of, and the opening instructions for, the sample problem, (5) descriptions of all the file organization and maintenance programs and instructions for their modification, and (6) descriptions and logic diagrams for selected user retrieval programs.

This program is a modified and extended version of the System/360 Bill of Material Processor. An appendix contains directions for conversion from System/360 Bill of Material Processor (360A-ME-06X). (548 pages)

SH20-0830 System/360 Data Base Organization and Maintenance Processor Operations Manual 65

Program Number: 5736-XX4

The System/360 Data Base Organization and Maintenance Processor is a programming system designed to create, maintain, and reorganize the

central data base in a multiapplication environment. It provides the framework for a computer-oriented information system. Primarily batch-oriented, the system operates under DOS/360.

This operations manual contains operating information for the creation, maintenance, and reorganization of the central data files. The primary audience includes operators, systems analysts, and programmers.

The items covered in this manual are:

1. Master File creation and Maintenance Modules
2. Chain File Creation and Maintenance Modules
3. Data Base Organization and Maintenance Processor Input/Output Modules to be used with user-prepared retrieval programs
4. File Reorganization Modules
5. A set of four Data Base Organizations and Maintenance Processor utility programs
6. Operator console messages

(72 pages)

GH20-0832 System/360 Remote Access 66
Computing System With Disk
Operating System (RAX-DOS)
Application Description

Program Number: 5799-AAA

This Programming RPQ is designed to allow Remote Access Computing System (RAX) to operate concurrently with Disk Operating System (DOS) in the background on a standard System/360 processor. It enables an installation with a single System/360 processor to provide the time-sharing, terminal operating capabilities of RAX with a minimum impact on DOS operations.

This publication contains a description of the system, the equipment requirements, RAX system capabilities, the elements of the RAX Terminal Command Language, and a discussion of the RAX system operation. For description of DOS, see *IBM System/260 Disk and Tape Operating System, Concepts and Facilities (GC24-5030)*. (36 pages)

SH20-0833 System/360 Text Processor 65
Pagination/360 Program Description
Volume 1

Program Number: 5736-K12

PAGINATION/360 consists of routines that accept input from a user-prepared disk-resident file. Input consists of textual material, text and page formatting commands, and output requests. After receiving a request for page makeup, the program processes the text into justified lines and composed pages according to the graphic, stylistic, and format requirements specified by user commands. This text is then written as generalized disk records which the user must retrieve and write on an appropriate systems output device. The program also provides for the storage and subsequent modification of text and commands and produces several forms of justified and page output.

This publication is divided into three volumes:

- Volume 1 contains general functional and processing descriptions of PAGINATION/360, system requirements, and performance; and detailed functional, operating, and

processing descriptions of PAGINATION/360 and its associated utility programs. A glossary is included.

- Volume 2 contains detailed descriptions of the various command languages, tables, and files that are used by PAGINATION/360.
- Volume 3 contains the information required by a user to write the input and output modules necessary to interface with PAGINATION/360.

A detailed knowledge of IBM Disk Operating System operating procedures is a prerequisite for using this publication. (276 pages)

SH20-0834 System/360 Text Processor 65
Pagination/360 Program Description
Volume 2

Program Number: 5736-K12

This manual contains detailed descriptions of the various command languages, tables, and files that are used by PAGINATION/360. It is designed to give the user a complete picture of the detailed use of these features.

Volume 2 contains the following information:

1. *Control Languages* – detailed description of the hot type and photocomposition languages.
2. *Page Makeup Language* – a detailed description of each page makeup command.
3. *Page Layout Specifications* – a general discussion of page layout specifications and a detailed description of the Page Format Files.
4. *Page Style Descriptors* – a detailed description of the Page Style Descriptor Files.
5. *Graphic Descriptors* – a detailed description of the Graphic Descriptor Files.
6. *Graphic Arrangement Table* – a detailed description of the Graphic Arrangement Tables.
7. *Files* – a detailed description of all records and files in the PAGINATION/360 system. (300 pages)

SH20-0835 System/360 Text Processor 65
Pagination/360 Program Description
Volume 3

Program Number: 5736-K12

This manual contains the details necessary for a user to write I/O modules. A general discussion of I/O module requirements is followed by the details concerning input programming and output programming. An appendix comprising all files read or written by the user's I/O module is included. (144 pages)

SH20-0836 System/360 Text Processor 65
Pagination/360 Operations Manual

Program Number 5736-K12

PAGINATION/360 consists of routines that accept input from a user-prepared disk resident file. Input consists of textual material, text formatting commands, page formatting commands, and output requests. After receiving a request for page makeup, the program processes the text into justified lines

and composed pages according to the graphic, stylistic, and format requirements specified by the user with the commands. This text is then written as generalized disk records which the user must retrieve and write on an appropriate systems device. The program also provides for the storage and subsequent modification of textual data as well as several different forms of justified and page output.

This publication contains system requirements, preparatory system procedures, a sample problem, and PAGINATION/360 operating procedures. Utility program operating procedures are included in Volume 1 of the Program Description Manual. A detailed knowledge of DOS operating procedures is a prerequisite for using this publication. (40 pages)

SH20-0837 System/360 Remote Access 65
Computing System With Disk Operating
System (RAX-DOS) Program
Description Manual

Program Number: 5799-AAA

This publication provides the information necessary to use the IBM System/360 Remote Access Computing System with Disk Operating System (RAX-DOS). It contains a description of the RAX-DOS systems concept, a discussion of the RAX program functions, the equipment requirements, the RAX Terminal Command Language and a description of RAX terminal operating procedures. For description of DOS, see the following publications:

- IBM System/360 Disk Operating System, System Control and System Service Programs (GC24-5036)*
- IBM System/360 Disk Operating System, Data Management Concepts (GC24-3427)* (96 pages)

GH20-0838 Introduction to Data/360 65
DOS

Program Number: 5736-XS2

DATA/360-DOS is a data entry program written in Assembler Language to operate under the Disk Operating System (DOS). Its purpose is to provide a method of entering data by means of local IBM 2260 Display Stations to IBM 2311 Disk Storage Drives or IBM 2314 Direct Access Storage Facilities and of verifying this data to produce input to a user's program, bypassing all peripheral equipment operations. Anticipated users are those currently using card equipment, magnetic tape recording and/or paper tape recording equipment.

The purpose of this publication is to present the inherent functions and capabilities of DATA/360-DOS.

The elaborated program description and the comprehensive input/output descriptions are the major items covered in this publication. (24 pages)

SH20-0843 System/360 Remote Access 65
Computing With Disk Operating
System (RAX-DOS) Operations
Manual

Program Number: 5799-AAA

This publication provides the System/360 machine operator with detailed instructions for starting,

running, and stopping the Remote Access Computing System with Disk Operating System (RAX-DOS). It includes machine requirements, descriptions of RAX online messages and their meanings, and RAX restart procedures. This manual also includes the procedures required for RAX system generation and RAX library maintenance.

For descriptions of operating and system generation procedures on DOS, see the following publications:

- IBM System/360 Disk Operating System, Operating Guide (GC24-5022)*
- IBM System/360 Disk Operating System, System Generation and Maintenance (GC24-5033)*

(40 pages)

GH20-0844 Management Information 60
System For Public Utilities With
The IBM System/370

This bulletin explains a system to provide assistance in the formulation and execution of plans in all areas and at all levels of public utility management through the use of management techniques and timely feedback of exception and status reports from previous plans. (12 pages)

SH20-0846 Agribusiness Management 65
Information System Program
Description

Program Number: 5736-D51

This manual contains information relating to the concepts, options, inputs, outputs, and processing methods used in the Agribusiness Management Information System (AMIS). This manual provides the reader with (1) a general introduction to AMIS options and processing, (2) specific information on using the system, and (3) considerations for implementing and installing the system. (380 pages)

SH20-0847 Agribusiness Management 65
Information System Operations
Manual

Program Number: 5736-D51

This manual presents the information required to set up the Agribusiness Management Information System (AMIS) and to execute the AMIS programs. The system operates under the IBM System/360 Disk Operating System (DOS). The AMIS programs are presented in the suggested running sequence. The information applicable to each program is presented in a separate section.

This manual is directed to those persons charged with the system. (132 pages)

GH20-0850 APL/360-OS (5734-XM6) 65
and APL/360-DOS (5736-XM6)
General Information Manual

This publication provides a general introduction to the use, operation, and installation of APL/360. APL/360 is a conversational time-shared terminal system utilizing APL (A Programming Language), a concise notation which makes use of well known

mathematical symbols, plus a number of symbols that are used for designating other simple and powerful functions. Because APL is closely related to mathematical notation, and its functions operate on sets of information as well as individual data items, the user can write effectively in this language with a minimum of instruction.

APL/360 is designed to operate under either (a) the IBM System/360 Operating System (OS/360). Multiprogramming with a Fixed Number of Tasks (MFT with subtasking) or Multiprogramming with a Variable Number of Tasks (MVT) or (b) the IBM System/360 Disk Operating System (DOS/360).

The manual is in three parts:

Part I describes APL/360 as viewed by a user at a typewriter-like terminal. The statements and commands used to describe the operations to be performed by the APL/360 System are summarized.

Part II describes APL/360 as viewed from the central data processing system location. The system features which facilitate the management and operation of an APL/360 System are summarized.

Part III describes the items to be considered in planning for the installation of an APL/360 System. Minimum machine requirements and storage requirements are provided. (72 pages)

SH20-0851 General Purpose Simulation 65
System V — User's Manual

Program Number: 5734-XS2

This publication is an extension and amplification of the manual entitled *General Purpose Simulation System V Introductory User's Manual* (SH20-0866). It provides a detailed description and explanation of the component parts and operation of the GPSS program. Examples illustrating the uses of GPSS entities and the coding of GPSS statements are given in appropriate sections. This manual should enable those involved in simulation projects to construct models using the full capabilities of GPSS. (436 pages)

GH20-0853 DATA/360-OS 65
General Information Manual

Program Number: 5734-XS3

DATA/360-OS is a data entry system written in Assembler Language to operate under the System/360 Operating System MFT or MVT (OS). Its purpose is to provide a method of entering data by means of local IBM 2260 Display Stations to IBM 2311, 2314, or 3330 direct access storage and of verifying this data to produce input to a user's program, bypassing all peripheral equipment operations. Anticipated users are those currently using card equipment, magnetic tape recording and/or paper tape recording equipment.

The purpose of this publication is to present the inherent functions and capabilities of DATA/360-OS.

The elaborated program description and the comprehensive input/output descriptions are the major items covered in this publication. (28 pages)

GH20-0856 Control Program — 67/ 61
Cambridge Monitor System
(CP-67/CMS) Version 3
CP-67 Operator's Guide

Program Number: 360D-05.2.005

CP-67 is a multiaccess system which allows multiple System 360 operating systems to run under it concurrently in a time-shared mode. These operating systems run in the same manner as they do on a dedicated System/360 computer. Some systems that have run under CP-67 are CMS, CMS Batch, CS, DCS, APL 36C, RAX, and CP-67.

This publication is intended to present to the operations staff responsible for the operation of CP-67, the facilities and responsibilities of the systems operator and administrator. It is divided into two basic parts: (1) the operator's guide, including instructions for system startup, shutdown, and emergency recovery procedures, and (2) instructions on the utilities included with the system, including device-formatting, allocation, and user definition. (72 pages)

GH20-0857 Control Program -67/ 61
Cambridge Monitor System (CP-67/
CMS) Version 3
Installation Guide

Program Number: 360D-05.2.005

The purpose of this document is to provide the installation with instructions on creating a runnable CP-67/CMS system tailored to his configuration. There are also considerations for tuning the system as well as maintaining both CP-67 and CMS.

This manual should be read in its entirety before installing the system, as procedures have changed. (56 pages)

GH20-0858 Control Program-67/ 61
Cambridge Monitor System
(CP-67/CMS) Version 3
Hardware Maintainability Guide

Program Number: 360D-05.2.005

The CP-67/CMS Hardware Maintainability Guide explains how to run Customer Engineer Diagnostics under CP-67, and describes the error-recording facility in CP-67. Topics discussed under diagnostics include limitations under CP-67, as well as conventions and instructions for running diagnostics under CP-67.

Sample terminal sessions for running DMA8 and FRIEND are included.

Topics covered under CP-67 Error-Recording Facility are the CP-67 error-recording mechanism, conditions and devices involved in recording, and instructions for retrieval of I/O error, channel check, and machine-check information. (56 pages)

GH20-0859 Control Program—67/ 61
Cambridge Monitor System
(CP-67/CMS) Version 3
User's Guide

Program Number: 360D-05.2.005

CP-67/CMS is a general purpose time-sharing system developed for the IBM 360. This guide

describes the facilities of CP-67/CMS and provides detailed information about the user commands available and their usage. (614 pages)

GH20-0860 Control Program – 67/ Cambridge Monitor System (CP-67/CMS) Version 3 CMS Script User's Manual 61

Program Number: 360D-05.2.005

This manual introduces you to the Script manuscript facility that operates under the Control Program-67/Cambridge Monitor System (CP-67/CMS). Script enables you to type in a manuscript, correct it, examine your corrections, and print it out – all at a typewriter terminal – with spacing performed automatically by the system. The spacing feature enables you to type in text lines, without regard to margins; your text is automatically formatted to fit within the margin size that you specify, as in book and newspaper printing. Other capabilities of Script include page numbering, page heading, tab setting, indentation, centering, margin setting (top and bottom of page, as well as right and left sides), double spacing, page skipping, line breaking, and several special features, such as entering lines from the terminal during manuscript printout. The hard copy, or finished product, can be outputted to either the typewriter terminal or offline printer.

Sample documents are provided for practice in creating, editing, and printing a Script file.

The procedure for logging in from CP-67 (the Control Program) to CMS, and document maintenance within CMS are explained.

The Edit facility in CMS is described in some detail. (72 pages)

SH20-0863 IBM System/360 Filing and Source Data Entry Techniques for Easier Retrieval Low Core (FASTER LC) 5736-G22 Program Description Manual 65

FASTER LC is a programming system for retrieving data from indexed-sequential files, and for maintaining such files, by means of remote or local terminal devices. The system procedures are adaptable to a wide variety of applications. FASTER LC incorporates a macro-language which provides for writing message processing programs on a functional level.

Through the use of the Basic Telecommunications Access Method, FASTER LC provides line control to support a communication network consisting of combinations of IBM 1050 and IBM 2740-1 typewriter terminals and the IBM 2260 display terminal.

FASTER LC operates as a standard job in a single partition under DOS/360, using a minimum of 32K bytes, on a System/360 Model 2025ED or larger.

This manual describes the FASTER LC system environment and components. Included are detailed macro instruction descriptions, and user considerations concerning backup/recovery, hardware, and documentation aids. (280 pages)

SH20-0864 System/360 Filing and Source Data Entry Techniques for Easier Retrieval Low Core (FASTER LC) 5736-G22 Operations Manual 65

This publication contains a description of the procedures necessary to implement FASTER LC in a test or on-line environment. Initialization of system files, linkage editing options, and system messages are discussed in addition to the maintenance transaction which is included with the program. (52 pages)

SH20-0866 General Purpose Simulation System V Introductory User's Manual 65

Program Number 5734-XS2

This manual provides a basic introduction to the use of the General Purpose Simulation System (GPSS). It is written for those individuals who have not had previous simulation experience.

The information presented is sufficient to enable new users to construct simple models within a short period of time. It is intended for an audience of those persons responsible for evaluating modeling techniques and constructing actual models.

Examples of the use of GPSS statements are given throughout the manual. These examples emphasize the basic features of the GPSS program and demonstrate the use of simple GPSS statements. A more complete, detailed description of all GPSS features may be found in the manual entitled *General Purpose Simulation System V User's Manual* (SH20-0851). Users should refer to a copy of the *User's Manual* when they begin to write more sophisticated models. (140 pages)

SH20-0867 General Purpose Simulation System V-OS (GPSS V-OS) Operations Manual 65

Program Number 5734-XS2

This manual contains sufficient information to enable the user to link-edit and incorporate the GPSS program into his system library for subsequent execution under the control of Operating System/360. Detailed examples are given for entering the GPSS program into either a private program library or the OS/360 program library, SYS1.LINKLIB. Other examples illustrate the OS/360 job control language (JCL) statements required to execute models that use various GPSS features which require additional JCL statements.

This manual describes and illustrates the quantity of GPSS entities required to fit modeling requirements. The various data sets required by GPSS are also illustrated and described. Explained in detail are several extended features of GPSS: Run Length, LOAD, user-written FORTRAN and PL/I HELP routines, and Auxiliary Storage. Sufficient examples are provided to enable the user to implement these features. (92 pages)

GH20-0888 Basic Courts System (BCS) Application Description Manual 65

Program Number 5736-G26

The Basic Courts System (BCS) provides judicial administrators with online calendar, case history, name index and identification number index information to assist them in the management of court operations. It is designed to function in criminal and civil courts on general and limited jurisdiction levels.

BCS utilizes the FASTER LC system (Program Product Number 5736-G22) and operates in a 56K problem program partition (includes FASTER LC) of a Model 2030 F or larger System/360, or a System/370 subject to the compatibility constraints announced for System/370.

This manual describes the features, advantages, and general design of the system. Planning information is also provided. (36 pages)

GH20-4006 System/360 LEARN ATS-DOS 65

Program Number 5736-XX3 PPS

LEARN ATS-DOS assists in the learning of the System/360 Administrative Terminal System command language for its use in source data entry, file maintenance, and text processing applications.

The program is designed primarily for people with no prior ATS terminal operations knowledge. The training program operates concurrently with, and in the same partition as, the DOS Version of ATS/360. This announced version of LEARN ATS operates only with Version 1 Modification Level 2 of ATS/360-DOS. (2 pages)

GH20-4007 System/360 LEARN ATS-OS 65

Program Number 5734-XX8 PPS

LEARN ATS-OS assists in the learning of the ATS/360 command language for its use in source data entry, file maintenance, and text processing applications. The program is designed primarily for people with no prior ATS terminal operations knowledge. The training program operates concurrently with, and in the same partition or region as, the OS Version of ATS/360. This announced version of LEARN ATS operates only with Version 1 Modification Level 1 of ATS/360-OS. (2 pages)

GH20-4014 System/360 Capacity Planning Infinite Loading 65

Program Number 5736-M11 PPS

This group of integrated programs is for work center loading in manufacturing organizations.

Programs are provided for determining labor and machine requirements by work center. (2 pages)

GH20-4017	Power System Planning Program	65	GH20-4024	Shop Floor Control	65	GH20-4065	IMS/360 General Information PPDO	30
<i>Program Number 5736-U12 PPS</i>			<i>Program Number 5736-M31 PPS</i>			This Program Product Design Objectives (PPDO) describes the design objectives and provides the estimated availability date of the subject Program Product.		
Using the Power System Planning (PSP) Program Product, the electrical planning engineer can obtain solutions to electrical network problems. PSP provides, through the Engineering Data Management Service (EDMS), programs to validate, organize, load and retrieve electrical power systems data for use by three simulation programs. These three programs simulate steady state line flows and station conditions (Power Flow), three-phase and single-phase line-to-ground faults (Short Circuit), and transient analysis of synchronous machine swings during predicted electrical system disturbances (Transient Stability). (2 pages)			Shop Floor Control consists of source programs and supporting documentation for use in the installation of an effective shop floor control system. The program (5736-M31) consists of four major functions: (1) order release, (2) open order maintenance, (3) general information retrieval and (4) work list preparation. (2 pages)			GH20-4067 IMS/360 Version 2 PPDO 65		
GH20-4021			GH20-4026			<i>Program Number 5734-XX6</i>		
Shared Laboratory Information System (SLIS) Program Product Specifications			System/360 Remote Access Computing System with Disk Operating System (RAX-DOS)			This Program Product Design Objectives (PPDO) describes the design objectives and provides the estimated availability date of the subject Program Product. (1 page)		
This Program Product Specifications (PPS) Specifications (PPS) describes the warranted specifications of the subject Program Product. (2 pages)			This Program Product Specifications (PPS) describes the warranted specifications of the subject Program Product. (17 pages)			GH20-4068		
GH20-4022			GH20-4027			DATA/360-PS PPDO		
Consumer Goods System (COGS) - Allocation			Agribusiness Management Information System (AMIS) 5736-D51			<i>Program Number 5734-X53</i>		
<i>Program Number 5736-D31 PPS</i>			This Program Product Specifications (PPS) describes the warranted specifications of the subject Program Product. (1 page)			This Program Product Design Objectives (PPDO) describes the design objectives and provides the estimated availability date of the subject Program Product. (2 pages)		
The IBM Consumer Goods System (COGS) - Allocation program provides the processor of consumer goods the ability to determine how much of various finished products to make and/or ship to stocking locations or distribution centers to satisfy service and inventory objectives while satisfying shipping incentives and/or restrictions. Simulation of the ordering process is included to allow a preview of the effects of management policy alternatives. (2 pages)			GH20-4028			APL/360-OS		
GH20-4023			GH20-4030			<i>Program Number 5734-XM6</i>		
The Consumer Goods System (COGS) - Forecasting			IBM System/360 Resource Allocation for Project Control System/360 (5736-XP2)			This Program Product Design Objectives (PPDO) describes the design objectives and provides the estimated availability date of the subject Program Product. (1 page)		
<i>Program Number 5736-D32 PPS</i>			This Program Product Specifications (PPS) describes the warranted specifications of the subject Program Product. (2 pages)			GH20-4074		
The COGS - Forecasting program product is based on a mathematical technique known as adaptive smoothing and is designed to produce forecasts for time periods of a year or less. Its design principle is that of building blocks: data, models, smoothing, forecasting, and error measurement. The data comes from past sales and/or estimates of demand from which the forecast is to be computed. Models are mathematical representations of reality - in this case, the demand pattern. Smoothing is the repetitive process of revising the elements of the model in the light of new information about demands. After current estimates of the model have been derived, the forecast is simply the evaluation of the model for a future point in time. With each revision of the forecast itself, the measurement of the forecast error is also revised. (2 pages)			GH20-4031			APL/360-DOS		
GH20-4032			GH20-4032			<i>Program Number 5736-XM6</i>		
Filing and Source Data Entry Techniques for Easier Retrieval - Low Core (FASTER LC)			Filing and Source Data Entry Techniques for Easier Retrieval - Low Core (FASTER LC)			This Program Product Design Objectives (PPDO) describes the design objectives and provides the estimated availability date of the subject Program Product. (4 pages)		
<i>Program Number (5736-G22)</i>			This Program Product Specifications (PPS) describes the warranted specifications of the subject Program Product. (2 pages)			GH20-4075		
GH20-4033			GH20-4033			Mathematical Programming System Extended (MPSX)		
The Consumer Goods System (COGS) - Forecasting			PALIS Additional File Facility (2314)			<i>Program Number 5734-XM4</i>		
<i>Program Number 5736-D32 PPS</i>			<i>Program Number 5736-N22</i>			This Program Product Design Objectives (PPDO) describes the design objectives and provides the estimated availability date of the subject Program Product. (4 pages)		
The COGS - Forecasting program product is based on a mathematical technique known as adaptive smoothing and is designed to produce forecasts for time periods of a year or less. Its design principle is that of building blocks: data, models, smoothing, forecasting, and error measurement. The data comes from past sales and/or estimates of demand from which the forecast is to be computed. Models are mathematical representations of reality - in this case, the demand pattern. Smoothing is the repetitive process of revising the elements of the model in the light of new information about demands. After current estimates of the model have been derived, the forecast is simply the evaluation of the model for a future point in time. With each revision of the forecast itself, the measurement of the forecast error is also revised. (2 pages)			This Program Product Specifications (PPS) describes the warranted specifications of the subject Program Product. (2 pages)			GH20-4153		
GH20-4034			GH20-4034			Customer Information Control System/DOS-Entry (CICS/DOS-Entry)		
The Consumer Goods System (COGS) - Forecasting			Filing and Source Data Entry Techniques for Easier Retrieval - Low Core (FASTER LC)			<i>Program Number 5736-XX6</i>		
<i>Program Number 5736-D32 PPS</i>			<i>Program Number (5736-G22)</i>			This Program Product Design Objectives (PPDO) describes the design objectives and provides the estimated availability date of the subject Program Product. (4 pages)		
The COGS - Forecasting program product is based on a mathematical technique known as adaptive smoothing and is designed to produce forecasts for time periods of a year or less. Its design principle is that of building blocks: data, models, smoothing, forecasting, and error measurement. The data comes from past sales and/or estimates of demand from which the forecast is to be computed. Models are mathematical representations of reality - in this case, the demand pattern. Smoothing is the repetitive process of revising the elements of the model in the light of new information about demands. After current estimates of the model have been derived, the forecast is simply the evaluation of the model for a future point in time. With each revision of the forecast itself, the measurement of the forecast error is also revised. (2 pages)			This Program Product Specifications (PPS) describes the warranted specifications of the subject Program Product. (2 pages)					

- GH20-4154 Customer Information 65**
Control System/DOS-Standard (CICS/
DOS-Standard)
Program Number 5736-XX7
 This Program Product Design Objectives (PPDO) describes the design objectives and provides the estimated availability date of the subject Program Product. (4 pages)
- GH20-4155 System/360 Consumer 65**
Goods System (COGS) – Allocation OS
Program Number 5734-D32
 This Program Product Design Objectives (PPDO) describes the design objectives and provides the estimated availability date of the subject Program Product. (2 pages)
- GH20-4156 The Consumer Goods 65**
System (COGS) – Forecasting OS
Program Number 5734-D33
 This Program Product Design Objectives (PPDO) describes the design objectives and provides the estimated availability date of the subject Program Product. (2 pages)
- GH20-4157 OS Capacity Planning – 65**
Infinite Loading
Program Number 5734-M53
 This Program Product Design Objectives (PPDO) describes the design objectives and provides the estimated availability date of the subject Program Product. (2 pages)
- GH20-4158 OS Capacity Planning – 65**
Finite Loading
Program Number 5734-M54
 This Program Product Design Objectives (PPDO) describes the design objectives and provides the estimated availability date of the subject Program Product. (2 pages)
- GH20-4159 OS/360 Requirements 65**
Planning Special Feature 6015
Program Number 5734-M51
 This Program Product Design Objectives (PPDO) describes the design objectives and provides the estimated availability date of the subject Program Product. (1 page)
- GH20-4160 OS Shop Floor Control 65**
Program Number 5734-M31
 This Program Product Design Objectives (PPDO) describes the design objectives and provides the estimated availability date of the subject Program Product. (2 pages)
- GH20-4161 Consolidated Functions 65**
Ordinary II – CFO II
Program Number 5736-N13
 This Program Product Design Objectives (PPDO) describes the design objectives and provides the estimated availability date of the subject Program Product. (2 pages)
- GH20-4166 Fare Quote/Ticketing 65**
Program Number 5736-T11
 This Program Product Design Objectives (PPDO) describes the design objectives and provides the estimated availability date of the subject Program Product. (1 page)
- GL19-0003 Custom System Description: 13**
IBM 2970 Model 8 Bank Terminal,
RPQ 858230
 The IBM 2970 Model 8 Bank Terminal consists of an input/output writer, cable-connected to a control unit. In combination with a System/360, the IBM 2970 Model 8 is used to perform banking transactions.
 Given in this manual is basic information useful in planning for 2970 Model 8's in a bank system, in programming bank applications, and in setup and operations by supervisors and tellers.
 This manual has been written for systems analysts and systems engineers with a knowledge of bank policies, programmers with a knowledge of the System/360 programming system used at their particular installation, and supervisors and tellers with a knowledge of their bank's procedures. (48 pages)
- GL22-6871 IBM System/360 2911 13**
Manual Switching Unit Models 1, 2,
and 5 and 2989 Remote Switching
Console Special Systems Feature
 This bulletin describes the function of the 2911 Manual Switching Unit and the 2989 Remote Switching Console for System/360 signal lines. (16 pages)
- GL22-6890 IBM 2930 Model 1 13**
Tape Intersystem Connecting Unit
 This bulletin describes the operation of the IBM 2930 Model 1 Tape Intersystem Connecting Unit, which is a special systems feature for connecting a 1401, 1410, 1460, or any 7000-series system to a System/360.
 The reader's familiarity with *IBM System/360 Principles of Operation*, Order Number GA22-6821 is presumed.
 Detailed information concerning interface lines is in the following publications: *IBM System/360 I/O Interface—Channel-to-Control Unit, Original Equipment Manufacturers' Information*, Order Number GA22-6843. *IBM 729 II, IV, V, VI Magnetic Tape Units, Original Equipment Manufacturers' Information*, Order Number GA22-6643. (20 pages)
- GL22-6901 IBM 2937 Models 1, 13**
2, and 3 Multiplier-Summation
Processor—Special Systems
Feature—RPQ 880626
 This bulletin describes the function of the multiplier summation processor as an input/output device of the IBM System/360. Physical and electrical requirements are given along with illustrations of the formation of final product sums. (16 pages)
- GL22-6902 IBM System/360 13**
Model 40 Sum of Products
Instruction—RPQ W12561
Special Systems Feature
 This bulletin describes the function of a new instruction, Sum of Products, as an option of System/360 Model 40. Computation of the convolution integral is possible with this single instruction. The instruction is described and timing and overflow considerations are given. (2 pages)
- GL22-6903 IBM System/360 Model 40 13**
Halfword Translate Instruction—RPQ
W13462 Special Systems Feature
 This bulletin describes the function of a new instruction, Halfword Translate, as an option of System/360 Model 40. The instruction is used in a data move operation. A description of the instruction is given, together with its timing. (2 pages)
- GL22-6921 IBM System/360 Custom 13**
Feature Description, 2903 Special
Control Unit Model 1—RPQ 880636
 This publication describes the organizational, functional, and operational characteristics of the IBM 2903 Special Control Unit Model 1, which permits attachment of a wide variety of nonstandard and conventional input/output devices to IBM System/360 Models 30, 40, 44, 50, 65, 67, and 75. Attachment of the 2903-1 to a System/360 is via the standard System/360 I/O interface of a selector or multiplexer channel.
 A detailed description of the functional units and interfaces of the 2903 is given, with particular emphasis on programming aspects of and design considerations for attached input/output adapters and external devices. Command, status, and sense information pertaining to the 2903 and the external devices is also included.
 The reader is assumed to have a knowledge of information-processing systems and to have read *IBM System/360 Principles of Operation*, Order Number GA22-6821. *IBM System/360 I/O Interface—Channel to Control Unit—OEMI*, Order Number GA22-6843 is required reference. Other related literature is listed by title and order number and briefly described in *IBM System/360 Bibliography*, Order Number GA22-6822. (48 pages)

GL22-6928 IBM Airlines Reservation System Remote Equipment—Installation Manual Physical Planning 15

This manual contains information necessary for planning the physical installation of the remote equipment for an IBM Airlines Reservation System.

In addition to technical information needed for physical installation planning, it contains recommendations and suggestions to be used as a guide only in planning an efficient and pleasant installation. The customer should make such arrangements as he deems necessary for professional consultant's services in planning his installation. It is important that local and national code requirements be adhered to by the customer. (32 pages)

GL22-6940 IBM 2969 Programmable Terminal Interchange Model 1 RPQ 888117: Special Feature Description 13

This reference manual contains a direct, comprehensive description of the IBM 2969 system structure; of the logical, translation, switching, and input/output operations; and of the interruption system.

The 2969-1 is a stored-program teleprocessing unit, which performs the functions of a highly sophisticated communications network central processing unit. It has the hardware capability of attaching various System/360 CPU's, and several synchronous and asynchronous devices via common carrier or private communication facilities.

The central processor may be an IBM System/360 Model 50, 65, or 195 under control of the Airlines Control Program (ACP) or an equivalent control program utilizing the same interface.

It is assumed that the reader has a knowledge of System/360 as defined in *IBM System/360 System Summary*, GA22-6810, and *IBM System/360 Principles of Operation*, GA22-6821. (148 pages)

GL22-6960 IBM Reservation System Custom Feature Description 13

This publication describes the functional and operational characteristics of the input/output units used as remote and local equipment in an IBM Reservation System. These input/output units form a subsystem for the generation and display of reservation messages to and from the central processing unit (CPU). The subsystem can attach to the CPU either directly, via wire lines, or remotely, via leased common-carrier or private telephone lines.

This manual is intended for users of reservation systems and assumes a background knowledge of data processing equipment and basic teleprocessing techniques. (28 pages)

GL27-3009 2905 Remote Multiplexer Component Description 13

This publication describes the IBM 2905 Remote Multiplexer and its operation. The 2905 is used with various IBM and common-carrier terminals and is connected to an IBM System/360 through

the IBM 2906 Data Transmission Unit. Communication facilities that can be used with the 2905 are specified.

Refer to *Planning and Installation of a Data Communications System Using IBM Line Adapters*, Order Number GA24-3435, for further information.

Other related literature is referenced by order number and briefly described in the *IBM System/360 Bibliography*, Order Number GA22-6822. (112 pages)

GL27-3010 IBM System/360 Custom Systems Unit, 2905 Remote Multiplexer, 2906 Transmission Control, Installation Manual—Physical Planning 13

This publication contains detailed physical-planning information for the IBM 2905 Remote Multiplexer and the IBM 2906 Transmission Control. Dimensions, weights, cable specifications, service clearances, physical specifications, and electrical and environmental requirements for each unit are included. (10 pages)

GL27-3037 IBM 2968 Model 8 Data Entry Unit Controller Installation Manual-Physical Planning 15

The IBM 2968 Model 8 Data Entry Unit Controller is an intermediate unit for attaching Data Entry Units to the type of communications network used for an IBM 1030 Data Collection System. It permits remote entry of data to a System/360 equipped with an IBM 2701, 2702, or 2703 or transmission to the IBM 1034 Card Punch.

The IBM 2968 Model 8 accepts numerical data from the Data Entry Units performs record length checking, and then (using an IBM Line Adapter) transmits the data over the communications network.

This manual provides physical planning information for the IBM 2968 Model 8 Data Entry Unit Controller. It includes dimensions and service clearances, weight, heat output, power and environment requirements, and cable descriptions.

This information is for engineers and technicians who plan for, install, or supervise the IBM 2968 Model 8 Data Entry Unit Controller. (24 pages)

Course Description Note

These publications describe a course, its objectives, length, intended audience, prerequisites, and course code. All materials required by the instructor and student are listed. Abstracts are included for education materials created especially for the course; abstract references are provided for the other materials.

GR20-1055 Data Processing Education - Course Selection Guide 90

The purpose of this guide is to help the customer plan curricula for people in his data processing installation. The guide contains curricula planning

sheets and abbreviated course descriptions for over 80 standard and PI courses offered by DP education. The back cover pocket is designed to contain a local education schedule, available from the DP Representative. (2 pages)

SR20-1078 System/360 Operator's Reference Guide 99

This reference guide provides instruction in the correct usage of switches, polling and addressing formats, as well as operating instructions, on System/360. (171 pages)

GR20-9105 IBM System/360 FORTRAN IV Language/One Coding 90

"See Course Description Note." (4 pages)

GX20-1702 Proportional Record Layout Format Forms 80

The front side of this form consists of the Proportional Record Layout Form. It is suitable for card, tape, and disk records. Positional markings are 00-99 and 01-100.

The back side of the form is the Record Format Form. This form permits record layouts to be prepared without the space limitations of positional markings. Space is also provided for reference data.

These forms are general-purpose and may be used for all systems. (25 per pad-11 x 16½)

GX20-1703 IBM System/360 Reference Data Card 85

The information on this card is a digest of the data contained in the *IBM System/360 Principles of Operation*, Order Number GA22-6821 and *IBM Basic Support Assembler with Input/Output Macros (8K Tape)*, Order Number GC24-3355. (Card-5 fold)

GX20-1704 IBM 2321 Data Cell Drive Reference Card, 3 folds 85

A capacity and transmission time reference card arranged in a tabular format. Formulas and examples of how to use the card are included. (6 pages)

GX20-1705 IBM 2311 Disk Cell Drive Reference Card 85

A capacity and transmission time reference card arranged in a tabular format. Formulas and examples of how to use the card are included. (Folded Card)

<p>GX20-1709 IBM System/360 Basic Programming Support—Basic Utilities Reference Card 85</p> <p>This reference card is a digest of Order Number GC28-6505. It contains information needed to make use of the Basic Programming Support Basic Utility Programs, including an example of coding and deck setup. (Folded Card)</p>	<p>GX20-1749 IBM System/360 DOS/TOS Reference Card PL/I 85</p> <p>Reference information based on data contained in the IBM System/360 PL/I Subset Reference Manual. (10 pages)</p>	<p>GX20-1808 Shared Laboratory Information System (SLIS) CLM Coding Sheet II 65</p> <p><i>Program Number: 5736-H12</i></p> <p>No abstract available. (25 pages)</p>
<p>GX20-1710 IBM 2314 Direct Access Storage Facility Capacity and Transmission Time Reference Card 85</p> <p>This reference card provides a convenient reference and several informative examples for planning and programming purposes. Tables include timing and capacity with and without keys. (1 page)</p>	<p>GX20-1751 IBM 2260 Display Format 80</p> <p>This coding sheet is used in designing displays for the 2260. The form provides space for a display to be transmitted from System/360 to a 2260, and expected operator response.</p>	<p>GX20-1809 Shared Laboratory Information System (SLIS) CLM Coding Sheet III 65</p> <p><i>Program Number: 5736-H12</i></p> <p>No abstract available. (25 pages)</p>
<p>GX20-1711 IBM System/360 Record Layout Worksheet 80</p> <p>Padded forms showing double word, word, half-word and byte boundaries. Bytes marked to accommodate packed-decimal digits. Provides for two records of 256 positions each, both in hexadecimal and decimal numbering. (25 per pad—11 x 16½)</p>	<p>GX20-1758 IBM System/360 Model 30 1401/1440/1460 Compatibility Feature Reference Card 85</p> <p>A reference card for the System/360 Model 30, 1401/1440/1460 Compatibility Feature. (10 pages)</p>	<p>GX20-1810 Call/360-OS PL/I Reference Card 85</p> <p><i>Program Number: 360A-CX-42X</i></p> <p>This reference card is intended to summarize essential details of the CALL/360-OS PL/I Language. It is based on information appearing in <i>CALL/360-OS PL/I Language Reference Manual</i> (GH20-0700) and <i>CALL/360-OS Terminal Operations Manual</i> (GH20-0787).</p> <p>This card will be further updated from time to time to reflect changes and improvements. However, the user should remember that the basic program documentation, which includes the above manuals, is the authoritative source of information and will first reflect such changes.</p> <p>This edition applies to Version 1, Modification Level 0, of CALL/360-OS(360A-CS-42X) and to all subsequent versions and modifications until otherwise indicated in new editions or Technical Newsletters.</p> <p>Changes are continually made to the information herein. Therefore, before using this publication, consult the latest System/360 SRL Newsletter (GN20-0360) for the editions that are applicable and current. (14 pages)</p>
<p>GX20-1717 IBM 2301 Drum Storage 85</p> <p>This reference card describes the capacity of the 2301 and the data transmission time requirements for records of various lengths. Formulas and examples supplement the tables. (Folded Card)</p>	<p>GX20-1759 IBM 1287 Optical Reader Design Formats 80</p> <p>This sheet contains formats for laying out forms to be read by the 1287. The form includes standard mark-read column designs, hand-print blocks from two to seven digits, and optical reference marks.</p>	
<p>GX20-1718 IBM 2303 Drum Storage Reference Card 85</p> <p>This reference card describes the capacity of the 2303 and the data transmission time requirements for records of various lengths. Formulas and examples are used to supplement the tables. (Card)</p>	<p>GX20-1761 Mathematical Programming Input Form 80</p> <p>This is a Mathematical Programming Input Form 25 sheets to a pad, 8 1/2 x 11, 3 hole punch.</p>	
<p>GX20-1733 IBM System/360 Operating System Data Management Macro Instruction 85</p> <p>Reference card. (28 pages)</p>	<p>GX20-1771 IBM System/360 Reference Data DOS Job Control Language Operator Communication Reference Card 85</p> <p>A reference card for DOS job control language operator communication. (14 pages)</p>	
<p>GX20-1739 System/360 Reference Data Linkage Editor 85</p> <p>The information in this form is a digest of the data contained in the <i>IBM System/360 Operating System Linkage Editor</i>, Order Number GC28-6538. (4-page pocket booklet)</p>	<p>GX20-1787 Direct Hexadecimal Fraction Table for Floating Point Numbers 85</p> <p>The following tables can be used to evaluate a floating point number represented in hexadecimal form. The technique uses a table lookup in the hexadecimal integer table, and a table lookup in the hexadecimal fraction table. The user unites the integer from the first table with the fraction from the second table, to form one number, and then performs a calculation to obtain the value of the floating point number.</p>	<p>GX20-1811 CALL/360-OS Basic Reference Card 85</p> <p><i>Program Number: 360A-CX-42X</i></p> <p>This reference card is intended to summarize essential details of the CALL/360 BASIC Language. It is based on information appearing in <i>CALL/360-OS BASIC Language Reference Manual</i> (GH20-0699) and <i>CALL/360-OS Terminal Operations Manual</i> (GH20-0787).</p> <p>This card will be further updated from time to time to reflect changes and improvements. However, the user should remember that the basic program documentation, which includes the above manuals, is the authoritative source of information and will first reflect such changes.</p> <p>This edition applies to Version 1, Modification Level 0, of CALL/360-OS (360A-CX-42X) and to all subsequent versions and modifications until otherwise indicated in new editions or Technical Newsletters.</p>
<p>GX20-1741 IBM 1287 Optical Reader Document Tracing Guide 80</p> <p>This card is a forms design guide for assisting the 1287 users in the physical layout of input documents. (Card—6¼ x 9¼)</p>	<p>GX20-1807 Shared Laboratory Information System (SLIS) CLM Coding Sheet I 65</p> <p><i>Program Number: 5736-H12</i></p> <p>No abstract available. (25 pages)</p>	

Changes are continually made to the information herein. Therefore, before using this publication, consult the latest System/360 SRL Newsletter (GN20-0360) for the editions that are applicable and current. (14 pages)

GX20-1812 85

This reference card is intended to summarize essential details of the CALL/360-OS FORTRAN Language. It is based on information appearing in *CALL/360-OS FORTRAN Language Reference Manual* (GH20-0710) and *CALL/360-OS Terminal Operations Manual* (GH20-0787).

This card will be further updated from time to time to reflect changes and improvements. However, the user should remember that the basic program documentation, which includes the above manuals, is the authoritative source of information and will first reflect such changes.

This edition applies to Version 1, Modification Level 0, of CALL/360-OS (360A-CX-42X) and to all subsequent versions and modifications until otherwise indicated in new editions or Technical Newsletters.

Changes are continually made to the information herein. Therefore, before using this publication, consult the latest System/360 SRL Newsletter (GN20-0360) for the editions that are applicable and current. (14 pages)

GX20-8020 Flowcharting Template 80

This template provides a convenient means for drawing standard symbols used frequently in flowcharting computer programs. (1 sheet)

GX21-9090 Output Format Specifications 80

Padded form. (25 per pad)

GX21-9091 Extension and Line Counter Specifications 80

Padded form. (25 per pad)

GX21-9093 Calculation Specifications 80

Padded form. (25 per pad)

GX22-6834 IBM System/360 Unit Record I/O Template 80

Equipment templates on acetate sheets, ¼ inch equals 1 foot scale, for planning machine room layouts. (1 sheet)

GX22-6835 IBM System/360 Hypertape Template 80

Equipment templates on acetate sheets, ¼ inch equals 1 foot scale, for planning machine room layouts. (1 sheet)

GX22-6837 Magnetic Tape Record Characteristics—IBM 2400 Series Magnetic Tape Units 85

This card is presented as an aid in estimating tape processing time and record capacity per reel. (Card)

GX22-6855 Magnetic Tape Template 80

Equipment templates on acetate sheets, ¼ inch equals 1 foot scale, for planning machine room layouts. (1 sheet)

GX22-6856 IBM System/360 Processors Template 80

Equipment templates on acetate sheets, ¼ inch equals 1 foot scale, for planning machine room layouts. (5 sheets)

GX22-6857 Communication Equipment Template 80

Equipment templates on acetate sheets, ¼ inch equals 1 foot scale, for planning machine room layouts. (1 sheet)

GX22-6858 Data Storage Template 80

Equipment for templates on acetate sheets, ¼ inch equals 1 foot scale, for planning machine room layouts. (3 sheets)

GX22-6859 IBM System/360 Consoles and Terminals Template 80

Equipment templates on acetate sheets, ¼ inch equals 1 foot scale, for planning machine room layouts. (2 sheets)

GX22-6860 Magnetic and Optical Character Readers Template 80

Equipment templates on acetate sheets, ¼ inch equals 1 foot scale, for planning machine room layouts. (1 sheet)

GX22-6894 IBM System/360 Processors Models 25, 30 and 40 80

Equipment templates on acetate sheets, ¼ inch equals 1 foot scale, for planning machine room layouts. (1 sheet)

GX22-6905 IBM System/360 Processor Model 67 Template 90

Equipment templates on acetate sheets, ¼ inch equals 1 foot scale, for planning machine room layouts. (5 sheets)

GX22-6914 IBM System/360 Processors Models 44 and 50 80

Equipment templates on acetate sheets, ¼ inch equals 1 foot scale, for planning machine room layouts. (4 sheets)

GX22-6923 IBM System/360 Model 85 Physical Planning Template 80

Equipment templates on acetate sheets, ¼ inch equals 1 foot scale, for planning machine room layouts. (4 pages)

GX22-6924 IBM System/360 Model 65 Multisystem Physical Planning Template 80

Equipment templates on acetate sheets, ¼ inch equals 1 foot scale, for planning machine room layouts. (4 pages)

GX22-6925 Field Engineering Furniture Template 80

Equipment templates on acetate sheets, ¼ inch equals 1 foot scale. (1 sheet)

GX24-3376 IBM System/360 Model 30 IBM 1052 Key-tabs 80

These key-tabs are fastened on the front of the keys on the IBM 1052 when the Model 30 is being operated in 1400 Compatibility mode. (Plastic Sheet—5½ x 8½)

GX24-3406 IBM System/360 Model 30 IBM 2702 Worksheet 80

Multiplexor channel multiplex mode loading evaluation for IBM System/360 Model 30 may indicate an apparent overload for the IBM 2702 Transmission Control Unit (when attached to the multiplexor channel). The IBM 2702 Worksheet is then used with an alternate procedure for evaluation of the 2702. This worksheet is designed for use with the alternate procedure for the 2702 described in *IBM System/360 Model 30 Channel Characteristics and Functional Evaluation*, Order Number GA24-3411. (25 per pad - 11 x 16½)

GX24-3407 IBM System/360 Model 30 Multiplexor Channel Worksheet 80

This worksheet is used to facilitate evaluation of the channel effects imposed upon IBM System/360 Model 30 when the multiplexor channel is operating in multiplex mode. The evaluation procedure is described in the *IBM System/360 Model 30 Channel Characteristics and Functional Evaluation*, Order Number GA24-3411. (25 per pad - 11 x 16½)

GX24-3448 IBM 1445 Printer Spacing Chart 80	GX24-5048 IBM System/360 Assembler Coding Form, BOS/DOS DTFSR Entries, Disk 80	GX28-6507 IBM System/360 Assembler Long Coding Form 80
This chart is scaled in non-photographic blue and provides 113 printing positions at eight characters per inch for carriage spacing of six lines per inch. Vertical rulings are shown for each inch or every eight characters apart to assist in printing layout. A carriage-control tape facilitates planning for tape punching. Space is available on the top of the form to indicate miscellaneous print line formats. (1 page)	Padded form, 25 per pad Coding form for recording source instructions for keypunching input to Assembler program. (1 page)	This form is designed to assist programmers in coding programs in the IBM System/360 special support basic assembler language, as described in Order Number GC28-6503. (25 per pad - 8 1/2 x 14)
GX24-3477 Compatibility Initialization Deck Coding Sheet 80	GX24-5055 IBM System/360 Assembler Coding Form, TOS/DOS MTMOD, CDMOD, and PRMOD Entries 80	GX28-6509 IBM System/360 Assembler Coding Form 80
This form is used to facilitate preparation of the Compatibility Initialization Deck (CID) when the 1401, 1440, and 1460 Compatibility Feature is used on the IBM System/360 Model 30. The form shows the codes required for each of the 32 cards used to lead the 1400 auxiliary storage A and B. The contents of the cards required for the initialization routine are also shown. Except for variable data, the forms are pre-printed. The card fields of the CID are described in detail in the <i>System/360 Model 30, 1400 Compatibility Feature</i> , Order Number GA24-3255. (1 sheet)	Padded form, 25 per pad Coding form for recording source instructions to be keypunched for Assembler program. (2 pages)	This form is designed to assist programmers in coding programs in the IBM System/360 operating system assembler language, as described in Order Number GC28-6514. (25 per pad - 8 1/2 x 14)
GX24-3541 Multiplexer Channel Worksheet - System/360 Model 25 Configuration A and B 80	X26-5508 IBM System/360 Process I/O Devices Template 80	GX28-6731 Operating System Chart 31
Padded form 25 per pad Worksheet is used to facilitate evaluation of the channel effects imposed upon IBM System/360 Model 25 when the multiplexer channel is operating in multiplex mode. The evaluation procedure is described in <i>IBM System/360 Model 25 Channel Characteristics and Functional Evaluation</i> , GA24-3538. (2 pages)	Equipment templates on acetate sheets 1/4 inch equals 1 foot scale for planning machine room layouts. (2 sheets)	No abstract available. (2 pages)
GX24-5046 IBM System/360 Assembler Coding Form, BPS/BOS/TOS/DOS DTFSR Entries, Card Read-Punch 80	GX27-2950 IBM 2250 Display Layout Sheet 80	GX28-6749 Operating System/360 Reference Card: Service Aids 85
Padded form, 25 per pad Coding form for recording source instructions to be key punched for input to Assembler program. (1 page)	A layout sheet to plan a display and formulate the associated program data. (1 sheet)	The information in this reference card is extracted from GC28-6719-0 and applies to release 19. The following diagram gives an example of the possible time the Service Aids would be used when analyzing a problem. It is intended to be a generalized description of the applications the Service Aids may be used for in debugging situations. (4 pages)
GX24-5047 IBM System/360 Assembler Coding Form, BPS/BOS/TOS/DOS DTFSR Entries, Printer and Printer-Keyboard 80	GX28-6383 IBM FORTRAN IV Reference Data 85	GX28-6812 IBM System/360 Model 44 Programming System Formats for Machine Check Interruption Diagnostics 85
Padded form, 25 per pad Coding form for recording source instructions for keypunching into input code for assembler program. (1 page)	FORTRAN IV information is included for IBM System/360 Basic Programming Support System (BPS Card and BPS Tape), IBM System/360 Tape Operating System (TOS), IBM System/360 Disk Operating System (DOS), IBM System/360 Operating System (E, G, and H), IBM System/360 Model 44 Programming System (44PS), IBM System/360 Time Sharing System (TSS), IBM 1130 System (1130), IBM 1800 System (1800), and United States of America Standards Institute (USASI). (8 pages)	When a machine-check interruption occurs, the system attempts to produce a diagnostic printout on the console typewriter and, if successful, places the machine in the wait state. This printout assists field engineering personnel in analyzing a malfunction, and it should be saved by the operator for their use. Panel 1 provides material introductory to the use of this reference card. Panels 2 and 3 describe the format of the printout. Panel 4 describes its content. Panel 4 may be used in conjunction with the first line of the diagnostic printout to determine the content of remaining lines. Subsequently, Panels 2 and 3 may be used to determine the significance of the various fields and digits of the selected items displayed. (2 pages)
GX28-6401 TSS/360 Quick Guide for Systems Programmers 3 1/2 x 8 1/2 Inch Booklet 20	GX28-6506 IBM System/360 Assembler Short Coding Form 80	SX28-6813 IBM System/360 OS/DOS ITF: PLI Reference Card Program Product Reference Card 85
This publication is designed to serve as a "quick guide" for System Programmers using TSS/360. It contains reference information about TSSS, assembler and control blocks. (32 pages)	This form is designed to assist programmers in coding programs in the IBM System/360 special support basic assembler language, as described in Order Number GC28-6503. (25 per pad - 8 1/2 x 11)	(12 pages)
GX28-7327 FORTRAN Coding Form 80		SX28-6814 IBM System/360 OS/DOS ITF: Basic Reference Card 85
Padded form, 25 per pad.		(12 pages)

GYB0-0540 CALL/360-OS Version 1 23
Basic Assembly Listings (360A-CX-42X)

This microfiche manual contains the source listings for the BASIC compiler program of CALL/360-OS. Only the microfiche edition is available. (44 cards)

GYB0-0541 CALL/360-OS Version 1 25
FORTTRAN-Assembly Listings
(360-CX-42X)

This microfiche manual contains the source listings for the FORTRAN compiler program of CALL/360-OS. Only the microfiche edition is available. (46 cards)

GYB0-0542 CALL/360-OS Version 1 29
PL/I Assembly Listings (360A-CX-42X)

This microfiche manual contains the source listings for the PL/I compiler of CALL/360-OS. Only the microfiche edition is available. (268 cards)

GYB0-0592 Control Program — 67/ 61
Cambridge Monitor System (CP-67/
CMS) Version 3 CP-67 Listings

Program Number: 360D-05.2.005

This manual contains the Version 3, PC-67 Assembly Listings. (27 cards)

GYB0-0593 Control Program — 67/ 61
Cambridge Monitor System (CP-67/
CMS) Version 3 CMS Listings

Program Number: 360D-05.2.005

This manual contains the Version 3, CMS Assembly Listings. (38 cards)

GYB0-0598 Compatibility Operating 61
System for Emulation of IBM
1410/7010 Data Processing Systems
Operating on IBM System/360
Model 50 [COS/50] [360D-11.1.025]
Microfiche Listings

This manual contains the listings of the Compatibility Operating System (COS/50). COS/50 is used with System/360 Compatibility Feature No. 4478, modified by RPQ F23666, to execute IBM 1410/7010 programs on an IBM System/360 Model 50. COS/50 operates as a problem program under the IBM System/360 Operating System. (7 cards)

LYC7-5000 IBM Operating System/360
DOS ITF

Program Numbers: 5736-RC1
5737-RC1

Contains Type I OS Program Listings and DOS/OS PTF listing. (107 cards)

LYC7-5001 IBM Operating System/360
DOS ITF

Program Numbers: 5736-RC1
5737-RC1

Contains Type I OS Program Listings and DOS/OS PTF listing. (38 cards)

LYC7-5002 IBM Operating System/360
DOS ITF

Program Numbers: 5736-RC1
5737-RC1

Contains Type I OS Program Listings and DOS/OS PTF listing. (66 cards)

LYC7-5003 IBM Operating System/360
DOS ITF

Program Numbers: 5736-RC1
5737-RC1

Contains Type I OS Program Listings and DOS/OS PTF listing. (107 cards)

LYC7-5004 IBM Operating System/360
DOS ITF

Program Numbers: 5736-RC1
5737-RC1

Contains Type I OS Program Listings and DOS/OS PTF listing. (38 cards)

LYC7-5005 IBM Operating System/360
DOS ITF

Program Numbers: 5736-RC1
5737-RC1

Contains Type I OS Program Listings and DOS/OS PTF listing. (66 cards)

LYC7-5006 IBM Operating
System/360 ITF

Program Numbers: 5734-RC1
5734-RC3

Contains Type I OS Program Listings and DOS/OS PTF listing. (39 cards)

LYC7-5007 IBM Operating
System/360 ITF

Program Numbers: 5734-RC1
5734-RC3

Contains Type I OS Program Listings and DOS/OS PTF listing. (94 cards)

LYC7-5008 IBM Operating
System/360 ITF

Program Numbers: 5734-RC1
5734-RC3

Contains Type I OS Program Listings and DOS/OS PTF listing. (67 cards)

LYC7-5009 IBM Operating
System/360 ITF

Program Numbers: 5734-RC1
5734-RC3

Contains Type I OS Program Listings and DOS/OS PTF listing. (67 cards)

LYC7-5010 IBM Operating
System/360 ITF

Program Numbers: 5734-RC1
5734-RC3

Contains Type I OS Program Listings and DOS/OS PTF listing. (942 cards)

LYC7-5011 IBM Operating
System/360 ITF

Program Numbers: 5734-RC1
5734-RC3

Contains Type I OS Program Listings and DOS/OS PTF listing. (392 cards)

GY20-0042 System/360 Data Conversion 60
Utility III Version 2 System Manual

Program Number: 360A-SE-26X

This manual provides detailed information to help the user gain a more thorough knowledge of the programming logic employed in the program macros. This manual presents a narrative for each macro which should be complemented by a listing of the basic tape.

The manual is available from Mechanicsburg to those who need it for either the modification or maintenance of the program. (76 pages)

GY20-0062 System/360 Flowchart 60
System Manual

Program Number: 360A-SE-22X

The IBM System/360 Flowchart program is a System/360 program designed to produce flowcharts. This documentation aid operates under DOS/360 and is intended to minimize the planning and effort required to produce and maintain documentation.

It gives the user ability to:

1. Produce clear, uniform, easily reproduced computer-generated flowcharts.
2. Keep flowcharts continually up to date.
3. Standardize flowcharting techniques throughout the installation.

This publication is used in conjunction with the System/360 Flowchart optional tape, which contains the source language input, the assembly listings, and the program logic flowcharts. The optional tape is available from the IBM Program Information Department at Hawthorne, New York. One 2400-foot reel of nine-track tape is required.

This publication contains the narrative for the flowcharts, switch and register usage, miscellaneous programming notes, and the internal record formats used by the program.

The User's Manual and the Operator's Manual are prerequisites to reading and using this publication. (92 pages)

- GY20-0065 Mathematical Programming System/360 Version 2 System Manual 60**
Program Number: 360A-CO-14X
 This manual provides detailed information to help the user understand the implementation of MPS/360. It is designed to be used with the program listings and flowcharts of MPS/360. (404 pages)
- GY20-0067 System/360 Data Conversion Utilities II, Version 2 (Sequential, Direct Access) System Manual 60**
Program Number: 360A-SE-20X
 This manual provides detailed information to help the user gain a more thorough knowledge of the programming logic employed in the program modules, subroutines, and macros.
 The manual presents, for each module and sub-routine, flowcharts, flowchart narrative, and switch and register listings. For each macro, a listing and macro narrative are provided. (256 pages)
- GY20-0071 System/360 Online Teller Program and Mortgage Loan Background Capability System Manual 60**
Program Number: 360A-FB-16X
 This manual contains detailed flowcharts for the online program and the file preparation programs. Program narratives and descriptions of switches are given in the Programmer's Manual and correlated to the flowcharts by cross-reference indexes. (278 pages)
- GY20-0075 General Purpose Simulation System/360 System Manual 60**
 This publication contains a description of the internal structure and basic operation of the GPSS/360 program. All eleven modules which make up the GPSS/360 program are discussed in general and, where appropriate, the operation of all routines within a given module is explained in detail.
 In general, the material presented throughout this manual is applicable to both the OS and DOS version of the GPSS/360 program. Specific differences are listed and described in Appendix D.
 The information contained in this manual should give the user a thorough understanding of the structure and operation of the GPSS/360 program so that HELP block routines or other modification may be more easily implemented. (407 pages)
- GY20-0080 System/360 APT Numerical Control Processor Version 2 System Manual 60**
Program Number: 360A-CN-10X
 This manual provides detailed information to assist the user in gaining a more thorough knowledge of the programming logic employed in the application. (920 pages)
- GY20-0083 Project Management System/360 Network Processor System Manual 60**
Program Number: 360A-CP-04X
 This manual presents a detailed description of subroutines and internal data formats of PMS/360 Network Processor. In conjunction with the program listings and flowcharts, it provides the user with a complete description of how this processor is implemented. (228 pages)
- GY20-0084 Project Management System/360 Version 2 Cost Processor System Manual 60**
Program Number: 360A-CP-04X
 This manual presents a detailed description of subroutines and internal data formats of PMS/360 Cost Processor. In conjunction with the program listings and flowcharts, it provides the user with a complete description of how this processor is implemented. (192 pages)
- GY20-0085 Project Management System/360 Version 2, Report Processor System Manual 60**
Program Number: 360A-CP-04X
 This manual presents a detailed description of subroutines and internal data formats of PMS/360 Report Processor. In conjunction with the program listings and flowcharts, it provides the user with a complete description of how this processor is implemented. (375 pages)
- GY20-0092 System/360 Scientific Subroutine Package Version 3 System Manual 60**
Program Number: 360A-CM-03X
 This manual provides flowchart information on the logic used in each subroutine of the System/360 Scientific Subroutine Package. All subroutine descriptions and listings are contained in the User's Manual. (264 pages)
- GY20-0096 Synchronous Transmit-Receive Access Method for DOS/360 System Manual 60**
Program Number: 360A-SE-32X
 This publication describes the architecture and logic of the Synchronous Transmit-Receive Access Method for DOS/360. The manual describes the process for generating STR capability into a DOS system, loading the access method, and logic. Included are:
 SYSGEN and STR loading
 Architecture
 Macro Expansions
 Routine Logic
 STR Error Recovery
 Control Block
 Prerequisites are:
 1. A basic knowledge of System/360 machine concepts.
2. A basic knowledge of DOS/360.
 3. A knowledge of principles of STR transmission.
 4. Understanding of the Synchronous Transmit-Receive Access Method User's Manual. (120 pages)
- GY20-0097 Synchronous Transmit-Receive Access Method for OS/360 System Manual 60**
Program Number: 360A-SE-33X
 This publication describes the architecture and logic of the Synchronous Transmit-Receive Access Method for OS/360. The manual describes the process for generating STR capability into an OS system, loading the access method, and logic. Included are:
 SYSGEN and STR loading
 Architecture
 Macro Expansions
 Routine Logic
 STR Error Recovery
 Control Block
 Prerequisites are:
 1. A basic knowledge of System/360 machine concepts.
 2. A basic knowledge of OS/360.
 3. A knowledge of principles of STR transmission.
 4. Understanding of the Synchronous Transmit-Receive Access Method User's Manual. (360 pages)
- GY20-0099 System/360 Bill of Material Processor, Version 2 System Manual 60**
Program Number: 360A-ME-06X
 This manual provides detailed information to assist the user in gaining a more thorough knowledge of the programming logic employed in the application.
 It contains detailed reference material for the file organization, maintenance, and reorganization program modules. (380 pages)
- GY20-0100 TEST/360 Control Card Edit and Analysis Program—Application Description 60**
Program Number: 360A-SE-25X
 This program is a stand-alone program for editing and analyzing network and message generation control cards before using the TEST/360 (Teleprocessing Environment Simulator Testing) system. TEST/360 is a confidential Type II program, which does not allow users the possibility of testing their input at other than specific datacenter locations. This program allows prior editing at any location approved and authorized by the regional datacenter.
 The TEST/360 Control Card Edit and Analysis Program provides the following:
 1. Edit of the 17 types of TEST/360 network and message generation control cards.
 2. Diagnostic message and column indicator for each edit error found.
 3. Estimated core storage requirements for the TEST/360 simulation being specified.
 4. Summary report of system, line, and terminal specifications.

5. Ability to edit sets of TEST/360 control cards in one pass.

Minimum configuration consists of a 64K System/360 Model 30 with 2540, 1403, 1052, and optionally, a 2400 (seven- or nine-track).

The source language used is System/360 Basic Assembler with an 8K BPS supervisor. (8 pages)

GY20-0101 System/360 Remote Access 60
Computing System (RAX) System
Manual

Program Number: 360A-CX-17X

This publication provides the systems programmer with detailed information about the RAX system. It contains flowcharts and descriptions of the routines making up the system. (376 pages)

GY20-0105 1400 Autocoder to COBOL 60
Conversion Aid Program Version 2
Program Description Manual

Program Number: 360A-SE-19X

This program is designed to aid in conversion to System/360 COBOL for all 1401, 1410, 1440, 1460 and 7010 users whose current applications are written in Autocoder, by (1) reducing the total effort required in program conversion, (2) freeing manpower of much of the routine reprogramming effort, and (3) eliminating many clerical errors associated with reprogramming.

This manual contains a general description of the program, the machine configuration used, and a sample problem. (56 pages)

GY20-0106 1400 Autocoder to COBOL 60
Conversion Aid Program Version 2
Operator's Manual

Program Number: 360A-SE-19X

This program is designed to aid in conversion to System/360 COBOL for all 1401, 1410, 1440, 1460, and 7010 users whose current applications are written predominately in Autocoder, by (1) reducing the total effort required in program conversion, (2) freeing manpower of much of the routine reprogramming effort, and (3) eliminating many clerical errors associated with reprogramming.

This manual contains the information necessary to run the program. It includes operating instructions, halts and message list, and storage map. Instructions are also provided for preparing a functioning system from the basic machine-readable material furnished by the Program Information Department. (108 pages)

GY20-0111 System/360 Continuous 60
System Modeling Program System
Manual

Program Number: 360A-CX-16X

This is an IBM System/360 program for the simulation of continuous systems. It provides an application-oriented input language that accepts problems

expressed in the form of either an analog block diagram or a system of ordinary differential equations. Data input and output are facilitated by means of application-oriented control statements.

This manual provides detailed information to help the user gain a thorough knowledge of the program's logic. It contains flowcharts, flowchart narratives, and tables of switches and data used in COMMON. It also includes a section describing the procedures for implementing several program modifications. (226 pages)

GY20-0112 IBM System/360 Product 60
Structure Retrieval Program
System Manual

Program Number: 360A-ME-07X

This manual provides detailed information to assist the user in gaining a more thorough knowledge of the programming logic employed in the application.

It contains reference material for the program modules included with the retrieval package. (54 pages)

GY20-0116 TEST/360 Control Card Edit 60
and Analysis Program—Program Reference
Manual

Program Number: 360A-SE-25X

This program is a stand-alone program for editing network and message generation control cards before using them in the TEST/360 (Teleprocessing Environmental Simulator Testing) system. The primary function of the program is to provide an efficient method of analyzing these control cards, TEST/360 is a confidential Type II program, which does not allow users the possibility of testing their input at other than specific datacenter locations. The edit and analysis program allows prior editing at any location.

The program provides the following:

1. Edit of the 17 types of TEST/360 network and message generation control cards.
2. Diagnostic message and column indicator for each edit error found.
3. Estimated core storage requirements for the TEST/360 simulation being specified.
4. Summary report of system, line, and terminal specifications.
5. Ability to edit sets of TEST/360 control cards in one pass.

Minimum configuration consists of a 64K System/360 Model 30 with 2540, 1403, and 1052. (40 pages)

GY20-0118 System/360 AD-APT/ 60
AUTOSPOT Numerical Control
Processor System Manual

Program Number: 360A-CN-09X

This manual provides detailed information to assist the user in gaining a more thorough knowledge of the programming logic employed in the application. Certain information, applicable to both this processor and the AUTOSPOT Processor (360A-CN-08X) will be found in the AUTOSPOT System Manual, Form Y20-0119. (234 pages)

GY20-0119 System/360 AUTOSPOT 60
Numerical Control Processor
System Manual

Program Number: 360A-CN-08X

This manual provides detailed information to assist the user in gaining a more thorough knowledge of the programming logic employed in the application. (404 pages)

GY20-0124 1400 Autocoder to COBOL 60
Conversion Aid Program
Version 2, System Manual

Program Number: 360A-SE-19X

This Conversion Aid Program is designed to ease the transition to System/360 for all 1401, 1410, 1440, 1460, and 7010 users whose current applications are written predominately in Autocoder and SPS, by (1) reducing the effort required in reprogramming, (2) freeing manpower from the reprogramming effort to develop new applications, (3) eliminating many clerical errors associated with reprogramming, and (4) making reystemization of the applications easier, since COBOL language is much easier to modify.

This manual contains information necessary to understand the workings of the program. Each phase is detailed and sufficient information is provided to allow the user to modify the program functions or its operating environment. Instructions for processing the optional tape material are also included. (92 pages)

GY20-0126 Project Control System/360 60
System Manual

Program Number: 360A-CP-06X

This manual describes the routines and subroutines that comprise the IBM Project Control System/360. It is divided into the seven logical phases of the system and is intended primarily for the programmer who wishes to gain an understanding of the programming design of the PCS/360. It provides the necessary information for maintaining and modifying the system. (128 pages)

GY20-0143 IBM System/360 Document 60
Processing System—System Manual

Program Number: 360A-CX-12X

This manual represents the information required to maintain or modify the internal logic of the IBM System/360 Document Processing System. Insofar as possible, all agreements, assumptions, and production aids used by the development programmers are included. (316 pages)

GY20-0153 Medical Information System 60
Programs (MISP) Application
Description

Program Number: 360A-UH-08L

A hospital must have the ability to respond quickly and accurately to the demands placed upon it. The application of electronic information processing

can help provide a solution to the recurring problem of improving service with limited resources.

The Medical Information System Programs (MISP) represent an application of information-processing equipment to answer this need. MISP is designed to assist in the installation of a teleprocessing system (hospital information system) linking the many different service areas in a hospital where complete and prompt patient care is a requirement. These areas include the nursing station, admitting, pharmacy, clinical laboratories, Xray, electrodiagnostics, dietary, operating room, central supply, and others.

This manual describes in general the purpose and functions of a hospital information system using MISP. (40 pages)

GY20-0154 Medical Information System 60
Programs (MISP) Program
Description Manual

Program Number: 360A-UH-08L

This manual contains detailed information on the functions of each program in MISP. In addition, all data sets and fields used by the programs are defined.

This manual is distributed with the programs to those who are qualified to receive them. (512 pages)

GY20-0157 Medical Information System 60
Programs (MISP) Operations Manual

Program Number: 360A-UH-08L

The Medical Information System Programs contain general executive modules, utilities, and user interfaces that provide the framework for a teleprocessing system using the System/360 Disk Operating System.

This manual describes the procedures necessary for initial preparation and generation of the MISP programs, tables and data sets, inclusion of the user application processing programs, initial loading of the user data sets under MISP, operating procedures for the central system and operation of the terminal devices that are part of a teleprocessing system running under MISP. The generation, inclusion in the system and the terminal operations for a sample processing program under MISP are also described.

This manual is distributed with the programs to those who are qualified to receive them. (304 pages)

GY20-0168 System/360 Vehicle 60
Scheduling Program, Scheduling
Production and Distance Listing
System Manual

Program Number: 360A-ST-06X

This manual provides detailed information to help the user gain a more thorough knowledge of the programming logic employed in the Schedule Production and Distance Listing phases of the System/360 Vehicle Scheduling Program. (40 pages)

GY20-0174 System/360 Administrative 60
Terminal System DOS (ATS/DOS)
System Manual

Program Number: 360A-CX-18X

This manual contains information on the system design, logic flow, and coding of the ATS/360 Program. It contains narrative which describes the significant programs which make up the system. Program flowcharts and assembly listings, although logically part of this manual, are not included in it. These are available on tape as described elsewhere. (206 pages)

GY20-0204 Project Management 60
System/360 Flowchart System
Manual

Program Number: 360A-CP-04X

This manual contains the flowcharts for Project Management System/360. It should be used in conjunction with the System Manuals for the Network Processor, Order Number GY20-0083, Cost Processor, Order Number GY20-0084, and Report Processor, Order Number GY20-0085. (308 pages)

GY20-0205 MARVEL/360 System 60
Manual

Program Number: 360A-CO-15X

MARVEL is a language processor for the data preparation, matrix generation, output analysis, and management report writing functions associated with the Mathematical Programming System/360 (360-A-CO-14X). MARVEL was designed and implemented to provide powerful functional capabilities in this fast-growing area of mathematical programming. In providing such a comprehensive language and processor capability, trade-offs were made that reduced execution speed.

MARVEL provides maximum customer utility as an input/output system for the development of new linear programming applications. This is an area where extended function is more significant than high performance. In a production environment where emphasis is on execution speed, MARVEL is less suitable.

This manual gives detailed information concerning the program logic for the purpose of making modifications to or doing maintenance work on the program. It is designed to be used with the program listings of MARVEL/360. (410 pages)

GY20-0208 System/360 Text 60
Processor HYPHENATION/360
System Manual

Program Number: 360A-DP-07X

HYPHENATION/360 provides division of words for text-processing applications where the addition of word syllables to a line to meet justification requirements is preferable to forcing the line to end in a complete word. This hyphenation capability is provided in the form of a module that can be linked with a user's System/360 text-processing program or the COMPOSITION/360 module of the IBM System/360 Text Processor.

Through program linkage, HYPHENATION/360 accepts a word from the user's program and determines the division points. The word, with the division points indicated, is returned to the user's program, where the portion to be retained on the line can be selected on the basis of the user's graphic requirements.

This manual provides detailed information to help the user gain a more thorough knowledge of the programming logic and techniques used in each of the component programs. The information includes program narrative, switch and register listings, storage allocation data, and program modification aids.

The manual is intended for use chiefly by systems analysts and programmers who may need to alter the component programs or otherwise engage in program maintenance.

Familiarity with the Program Description Manual, Order Number GH20-0525 and Operations Manual, Order Number GH20-0526 is a prerequisite to reading and using this publication. (44 pages)

GY20-0209 System/360 1287 60
Input Conversion Program
System Manual

Program Number: 360A-DR-07X

This program consists of a Transaction Specification Compiler and an Operational Processor. The Compiler processes the statements which describe the format and processing logic to be applied to documents scanned by the IBM 1287 Optical Reader. The output of the Compiler is a program module written in Assembly Language.

The program module is assembled and linked with the Operational Processor and existing program modules. The Operational Processor controls the execution of the various program modules and converts the data to a conversion journal, error journal, and correction turnaround documents.

Provision is made for correcting the error journal and updating the conversion journal. (212 pages)

GY20-0211 Data Acquisition 60
Multiprogramming System/360
Model 44 (DAMPS) System
Manual

Program Number: 360A-CX-20X

This publication describes the internal logic of the DAMPS/44 extensions to the System/360 Model 44 Programming System. It is designed for persons involved in program maintenance, and system programmers who are altering the program design. Program logic is not required for system construction, use, or operations. (170 pages)

GY20-0213 Student Scheduling 60
System/360, The Scheduler
Program System Manual

Program Number: 360A-US-07X

This manual provides detailed information to assist the user in gaining a more thorough knowledge of the programming logic employed in the application.

It presents, for each phase, flowcharts, flowchart narrative, a list of switches, an index register list, programming notes, and program listings. (644 pages)

GY20-0215 Shared Hospital Accounting System (SHAS) System Manual 60

Program Number: 360A-UH-11X

The Shared Hospital Accounting System (SHAS) provides hospital accounting for a multiple-hospital environment. The participating hospitals utilize the application programs of a central System/360 facility. The application programs include accounts receivable, patient billing, general ledger and system executive and monitor routines.

This manual contains detailed program information useful for program modification, error diagnosis situations, and maintenance performance. The manual contains detailed descriptive information on the logical operation of each program through program flowcharts. Most flowchart narratives are general—more detail has been included for the complicated programs. Labels and symbols, programmed switches, program indicators, register usage, special techniques, program modification notes, and service subprogram usage are defined for each system program.

A chart that indicates storage allocation of core storage required by each program has been included as an appendix.

Data listings included are examples which might be used by a typical SHAS user. Data shown has been used to load the files and run the sample problem. The data includes label books, function books, hospital profile load data, edit specifications, sample-problem data, and control cards.

This document is written as a reference manual. Before using this manual the reader should be thoroughly familiar with the following manuals:

Shared Hospital Accounting System Application Description Manual, Order Number GH20-0302.

Shared Hospital Accounting System Program Description Manual, Order Number GH20-0533.

Shared Hospital Accounting System Operations Manual, Order Number GH20-0534. (764 pages)

GY20-0227 System/360 APT Numerical Control Processor Version 3 System Manual Flowcharts 60

Program Number: 360A-CN-10X

This manual consists entirely of flowcharts for the subject program. (280 pages)

GY20-0230 System/360 Wholesale IMPACT Program Library System Manual 60

Program Numbers: 360A-DW-05X, Version 2 360V-DW-06X

The System Manual provides detailed information to assist the user in gaining a more thorough

knowledge of the programming logic employed in the application.

This manual presents, for each run, general description, flowcharts, flowchart narrative, programming notes, and a switch and register listing. For each operating system with which the IMPACT Programs can be run, there is an Input/Output Section listing, Control Systems Macro listing, core storage requirements, and storage maps. (480 pages)

GY20-0251 Shared Hospital Accounting System (SHAS) Teleprocessing System Manual 60

Program Number: 360A-UH-11X

The Shared Hospital Accounting System (SHAS) provides hospital accounting for a multiple-hospital environment. The participating hospitals utilize the application programs of a central System/360 facility. The application programs include accounts receivable, patient billing, general ledger and system executive and monitor routines.

This reference publication is used for additional support of SHAS teleprocessing executive and control programs. The manual contains detailed program information useful for program modification, error diagnosis situations, and maintenance performance. This manual contains detail descriptive information on the logical operation of each program through program flowcharts. The program flowcharts are very detailed; every line of code is depicted. The narratives are general for the most part—more detail has been included for the complicated program segments. Program switches, register usage, and labels and symbols are defined for each system program module. (68 pages)

GY20-0256 System/360 Inventory Control System Manual 60

Program Number: 360A-MF-04X

System/360 Inventory Control consists of nine programs especially designed for implementing order point inventory control in manufacturing organizations.

This manual provides detailed information to assist the user in obtaining a more thorough knowledge of the program logic employed in the programs.

The manual includes program flowcharts and flowchart narratives in addition to information regarding switches, labels, symbols, and register assignment. (108 pages)

GY20-0261 System/360 Matrix Language (MATLAN) System Manual 60

Program Number: 360A-CM-05X

This manual provides detailed information about the structure and the implementation of MATLAN. It should be read in connection with the program listings and the flowcharts of the MATLAN subroutines. (832 pages)

GY20-0262 IBM System/360 Model 44 Remote Access Computing System (RAX) System Manual 60

Program Number: 360A-CX-21X

This publication provides the systems programmer with detailed information about the RAX system. It contains flowcharts and descriptions of the routines making up the system. (260 pages)

GY20-0263 System/360 Decision Logic Translator System Manual 60

Program Number: 360A-CX-32X

This manual provides detailed information to assist the user in gaining a more thorough knowledge of the programming logic employed in the application. The System Manual is optional information available to the user and includes the flowchart narrative, the programmed switch listing, the storage allocation, etc. Other material consists of the source program, the assembly listing, and the flowcharts, recorded on the optional tape. (28 pages)

GY20-0267 System/360 AD-APT/AUTOSPOT (OS) Numerical Control Processor System Manual 60

Program Number: 360A-CN-12X

This manual provides detailed information to assist the user in gaining a more thorough knowledge of the programming logic employed in the application. (600 pages)

GY20-0294 Mathematical Programming System/360 Report Generator (MPSRG) System Manual 60

Program Number: 360A-CQ-20X

This manual provides detailed information to help the user understand the organization and structure of MPS/360 Report Generator. It is designed to be used with the program listing of MPS/360 Report Generator. (92 pages)

GY20-0304 Project Control System/360, Version 2 Listings—System Manual Microfiche 60

This publication contains the DOS assembler and DOS FORTRAN compiler output listings for Project Control System/360 (PCS/360) Version 2. (825 pages)

GY20-0305 System/360 Attached Support Processor System (ASP) Version 2 System Manual 60

Program Number: 360A-CX-15X

The Attached Support Processor (ASP) system is an operating system that provides a compatible extension to System/360 Operating System. Designed primarily for the commercial and scientific customer with a computer job shop environment,

ASP provides for increased automation of the computing operation. The ASP system operates as a programmed operator of OS/360, providing an operational interface for controlling the system job stream, thus optimizing the use of the computer's resources.

This manual is intended primarily for the use of the system programmer at an installation. It contains a detailed description of each of the programs that constitute the ASP system and flowcharts of the programs (Appendix A). The material in this manual has been prepared on the assumption that the programmer is thoroughly familiar with the *ASP Application Programmer's Manual*, Order Number GH20-0322, the *ASP System Programmer's Manual*, Order Number GH20-0323, and the *ASP Console Operator's Manual*, Order Number GH20-0321. (324 pages)

GY20-0312 Program for Optical System Design/II (POSD/II) System Manual 60

Program Numbers:
1130-EO-14X
360A-EO-15X
360A-16X

This manual is intended to serve as a programmer's guide to the POSD/II system. Flowcharts, symbol and switch definitions, and calling sequences are given for all routines. The flowcharts are written in a descriptive fashion and are intended to provide a cross-reference between the program functions and pertinent material in the Program Description Manual. Where applicable, abstracts are included describing particular programming requirements.

This manual presumes a knowledge of the POSD/II Program Description Manual, the FORTRAN language, either the 1130 Monitor or System/360 DOS or OS, and the PLAN submonitor system. (132 pages)

GY20-0314 Mathematical Programming System/360 Report Generator (MPSRG) Assembly Listings System Manual Microfiche 60

Program Number: 360A-CO-20X

This manual contains the assembly listings of the seven procedures and subroutines of MPS/360 Report Generator (MPSRG). They should be used in conjunction with the System Manual, Order Number GY20-0294, which contains descriptions and flowcharts of the routines. (225 pages)

GY20-0317 System/360 Requirements Planning System Manual 60

Program Number: 360A-MF-05X

The IBM System/360 Requirements Planning programs are used to generate material requirements for finished products, assemblies, subassemblies, parts, and raw materials based upon an input of a forecast and/or orders. System/360 Requirements Planning consists of two programs: Requirements Generation Program and Print Exception Program. Requirements Generation performs the generation of requirements, utilizing time series planning to

determine gross requirements, determine net requirements, plan orders, determine offset, and post component gross requirements. Print Exception prints the notices for the exceptions discovered during the requirements generation run.

This manual includes program flowcharts and flowchart narratives, in addition to information regarding switches, labels, symbols, and register assignment. (424 pages)

GY20-0318 System/360 Text Processor COMPOSITION/360 Volume I—Flowchart Narratives—System Manual 60

Program Number: 360A-DP-08X

The COMPOSITION/360 component of the IBM System/360 Text Processor consists of control and functional routines which retrieve text from a user-prepared disk-resident file, justify and format text according to instructions supplied with the text, and produce generalized disk output records. The user must provide routines to retrieve this generalized information, convert it into coding acceptable to the specific composition device on which final printing will occur and write it to the appropriate systems output device. If word division capabilities are required, COMPOSITION/360 uses the hyphenation/360 component of the System/360 Text Processor (360A-DP-07X).

The two-volume System Manual provides detailed information to assist the user in acquiring a thorough knowledge of the programming logic and techniques used in each of the COMPOSITION/360 components.

This manual is intended for use chiefly by systems analysts and programmers who may need to alter or maintain the program. The Program Description Manual and Operations Manual are prerequisites to reading and using this publication.

Volume I of the System Manual contains storage allocation data, flowchart narratives, switch and register lists, and program modification aids. The COMPOSITION/360 program logic flowcharts are contained in Volume II. (204 pages)

GY20-0319 System/360 Text Processor COMPOSITION/360 Volume II Flowcharts System Manual 60

Program Number: 360A-DP-08X

The COMPOSITION/360 component of the IBM System/360 Text Processor consists of control and functional routines which retrieve text from a user-prepared disk-resident file, justify and format text according to instructions supplied with the text, and produce generalized disk output records. The user must provide routines to retrieve this generalized information, convert it into coding acceptable to the specific composition device on which final printing will occur, and write it to the appropriate systems output device. If word division capabilities are required, COMPOSITION/360 uses the HYPHENATION/360 component of the System/360 Text Processor (360A-DP-07X).

The two-volume System Manual provides detailed information to assist the user in acquiring a thorough knowledge of the programming logic and techniques used in each of the COMPOSITION/360 components.

This manual is intended for use chiefly by systems analysts and programmers who may need to alter or maintain the program. The Program Description Manual and Operations Manual are prerequisites to reading and using this publication.

This manual contains the program logic flowcharts for COMPOSITION/360. Storage allocation data, flowchart narratives, switch and register lists, and program modification aids are contained in Volume I. (300 pages)

GY20-0320 IBM System/360 Administrative Terminal System—OS(ATS/OS) System Manual 60

Program Number: 360A-CX-19X

This manual contains information on the system design, logic flow, and coding of the ATS/360 Program. It describes the significant programs that make up the system. Program flowcharts and program listings, although logically part of the material discussed in this manual, are not included. These items are available as optional material on tape, distributed by the Program Information Department. (196 pages)

GY20-0346 System/360 Problem Language Analyzer (PLAN) (DOS/OS) Volume II Flowcharts System Manual 60

Program Numbers:
360A-CX-26X
360A-CX-27X

This manual contains detailed flowcharts showing the internal logic of the OS and DOS/360 Problem Language Analyzer (PLAN). It is intended to assist systems programmers and field engineers in obtaining a fuller understanding of the logic and programming aspects of the PLAN system. (228 pages)

GY20-0348 System/360 AD-APT/AUTOSPOT (OS) Numerical Control Processor Assembly Listings System Manual—Microfiche 60

Program Number: 360A-CN-12X

This manual contains assembly listings for System/360-AD-APT/AUTOSPOT (OS) Numerical Control Processor. They should be used in conjunction with the *System Manual*, Order Number GY20-0267. (3006 pages)

GY20-0350 System/360 Problem Language Analyzer (PLAN) (DOS) Volume III Assembly Listings System Manual 60

Program Number: 360A-CX-26X

This manual provides assembly and compilation listings for the DOS PLAN system. (632 pages)

<p>GY20-0351 System/360 Problem Language Analyzer (PLAN) (OS) Volume IV Assembly Listings System Manual 60</p> <p><i>Program Number: 360A-CX-27X</i></p> <p>This manual provides assembly and compilation listings for the OS PLAN system. (544 pages)</p>	<p>LY20-0474 Rigid Frame Selection Program (RFSP) Volume 4—Compilation Listings System Manual 65</p> <p><i>Program Number: 5736-EC1</i> <i>Feature Code: 8501</i></p> <p>This manual provides the DOS/360 compilation listings for the Rigid Frame Selection Program. The flowcharts and narratives for this program will be found in the <i>Rigid Frame Selection Program (RFSP), System Manual—Volume 1</i> (GY20-0316). (308 pages)</p>	<p>LY20-0483 General Purpose Simulation System/360 DOS, Version 2: System Manual 65</p> <p><i>Program Number: 5736-XS1</i> <i>Feature Code: 8101</i></p> <p>This publication contains a description of the internal structure and basic operation of the GPSS/360 program. All eleven modules which make up the GPSS/360 program are discussed in general and, where appropriate, the operation of all routines within a given module is explained in detail.</p> <p>The information contained in this manual should give the user a thorough understanding of the structure and operation of the GPSS/360 program so that modifications may be more easily designed and implemented. (646 pages)</p>
<p>GY20-0357 System/360 APT Numerical Control Processor Version 4 Assembly Listings System Manual—Microfiche 60</p> <p><i>Program Number: 360A-CN-10X</i></p> <p>This manual contains the assembly listings for the subject program. (5631 pages)</p>	<p>Y20-0475 General Purpose Simulation System/360 OS Version 2 System Manual 65</p> <p><i>Program Number: 5734-XS1</i> <i>Feature Code: 8101</i></p> <p>This publication contains a description of the internal structure and basic operation of the GPSS/360 program. All eleven modules which make up the GPSS/360 program are discussed in general and, where appropriate, the operation of all routines within a given module is explained in detail.</p> <p>The information contained in this manual should give the user a thorough understanding of the structure and operation of the GPSS/360 program so that modifications may be more easily designed and implemented. (646 pages)</p>	<p>LY20-0489 System/360 Text Processor—EDIT/360: System Manual, Volume I Flowchart Narratives 65</p> <p><i>Program Product: 5736-K11</i> <i>Feature Code: 8019</i></p> <p>The EDIT/360 component of the IBM System/360 Text Processor consists of control and functional routines which retrieve input from a user-prepared disk-resident file. Input consists of textual material, text-formatting commands, and output requests. After the output text has been proofread, alterations can be made to store textual data through the use of text modification commands without reentering the original text input. Completely justified and corrected text is written as generalized disk records. The user must provide routines to retrieve this generalized information, convert it into coding acceptable to the specific composition device on which final printing will occur, and write it to the appropriate systems output device. If word division capabilities are required, EDIT/360 uses the HYPHENATION/360 component of the System/360 Text Processor (360A-DP-07X).</p> <p>The two-volume System Manual provides detailed information to assist the user in acquiring a thorough knowledge of the programming logic and techniques used in each of the EDIT/360 components.</p> <p>This manual is intended for use chiefly by systems analysts and programmers who may need to alter or maintain the program. The Program Description Manual and Operations Manual are prerequisites to reading and using this publication.</p> <p>Volume I of the System Manual contains storage allocation data, flowchart narratives, switch and register lists, and program modification aids. The EDIT/360 program logic flowcharts are contained in Volume II. (272 pages)</p>
<p>GY20-0364 System/360 Program for Optical System Design/II (POSD/II) (OS) Assembly Listings System Manual 60</p> <p><i>Program Number: 360A-EO-15X</i></p> <p>This manual contains the compile listings for OS/360 POSD/II. Refer to GY20-0312 for the flowcharts and narratives. (216 pages)</p>	<p>LY20-0480 SHAS Compatible Teleprocessing Support for 2780, 2740, and 1050 Terminals System Reference Manual 65</p> <p><i>Program Number: 5736-H13</i> <i>Feature Code: 8000</i></p> <p>The IBM SHAS Compatible Teleprocessing Support for 2780, 2740, and 2050 Terminals under DOS QTAM extends the device support available under the SHAS (Shared Hospital Accounting Systems) teleprocessing executive to include IBM 2780, IBM 2740, and IBM 1050 Terminals, singly or in combination. Prerequisite programs include SHAS (360A-UH-11X)(at Version 2, Modification Level 0 or higher) and DOS QTAM (360N-CQ-470). Prerequisite publications included.</p> <p><i>SHAS Application Description Manual (GH20-0302)</i> <i>SHAS Program Description Manual (GH20-0533)</i> <i>SHAS Operations Manual (GH20-0534)</i> <i>SHAS Teleprocessing Operations Manual (GH20-0550)</i> <i>SHAS Application System Manual (GY20-0215)</i> <i>SHAS Teleprocessing System Manual (GY20-0251)</i></p> <p>This manual is written for individuals with a thorough understanding of DOS System/360 Assembler Language, DOS QTAM, and SHAS. It contains operations, program description, and systems material. (80 pages)</p>	<p>LY20-0490 System/360 Text Processor—EDIT/360: System Manual, Volume II Flowcharts 65</p> <p><i>Program Number: 5736-K11</i> <i>Feature Code: 8020</i></p> <p>The EDIT/360 component of the IBM System/360 Text Processor consists of control and functional routines which retrieve input from a user-prepared disk-resident file. Input consists of textual material,</p>
<p>GY20-0365 System/360 Program for Optical System Design/II (POSD/II) (DOS) Assembly Listings System Manual 60</p> <p><i>Program Number: 360A-EO-16X</i></p> <p>This manual contains the compile listings for DOS/360 POSD/II. Refer to GY20-0312 for the flowcharts and narratives. (186 pages)</p>	<p>LY20-0455 Graphic Analysis of Three-Dimensional Data (GATD): System Manual—Volume I 65</p> <p><i>Program Number: 5734-XX2</i> <i>Feature Code: 8101</i></p> <p>This manual contains the program flowcharts and narratives, core storage requirements, panel listings, and phrase listings for the GATD program.</p> <p>The program listings for GATD will be found in Volume 2 of the GATD System Manual, Order Number LYBO-0465, on microfiche cards. (152 pages)</p>	
<p>LY20-0473 Rigid Frame Selection Program (RFSP) Volume 3—Compilation Listings System Manual 65</p> <p><i>Program Number: 5734-EC1</i> <i>Feature Code: 8501</i></p> <p>This manual provides the OS/360 compilation listings for the Rigid Frame Selection Program. The flowcharts and narratives for this program will be found in the <i>Rigid Frame Selection Program (RFSP), System Manual—Volume 1</i> (GY20-0316). (316 pages)</p>		

text-formatting commands, and output requests. After the output text has been proofread, alterations can be made to stored textual data through the use of text modification commands without reentering the original text input. Completely justified and corrected text is written as generalized disk records. The user must provide routines to retrieve this generalized information, convert it into coding acceptable to the specific composition device on which final printing will occur, and write it to the appropriate systems output device. If word division capabilities are required, EDIT/360 uses the HYPHENATION/360 component of the System/360 Text Processor (360A-DP-07X).

The two-volume System Manual provides detailed information to assist the user in acquiring a thorough knowledge of the programming logic and techniques used in each of the EDIT/360 components.

This manual is intended for use chiefly by systems analysts and programmers who may need to alter or maintain the program. The Program Description Manual and Operations Manual are prerequisites to reading and using this publication.

This manual contains the program logic flowcharts for EDIT/360. Storage allocation data, flowchart narratives, switch and register lists, and program modification aids are contained in Volume I. (540 pages)

LY20-0493 DATA/360-DOS 65
System Manual Preliminary Version

Program Number: 5736-XX2
Feature Code: 8018

This manual contains detailed descriptions and procedures for system generation and modification. This publication also contains abstract descriptions and functional flowcharts for all key modules. To further assist the system programmer, console operator, and terminal operator, a set of sample problems and running instructions with sample outputs are included. (100 pages)

LY20-0495 Coursewriter III for 65
System/360 (OS) Version 2
Programmer's Guide

Program Number: 5734-E12
Feature Code: 8000

This publication provides detailed information to assist the user in gaining a more thorough knowledge of the programming logic used in the application. Flowcharts and subroutine descriptions are not in this publication (see Application Directory). (68 pages)

LY20-0496 System/360 Order 65
Allocation System
System Manual

Program Number: 5736-D41
Feature Code: 8700

This manual will assist the user in understanding the system and act as an aid in modifying the system components. It consists of the program flowchart and the program source listing for each of the

Order Allocation System modules. The flowcharts provide a semidetailed, visual tool that shows the logical sequence of operations performed by the program. Flowchart narratives are provided for the allocation and shipping programs, as these programs are the heart of the Order Allocation System and use the most complex coding techniques.

The appendix to this manual contains cross-reference charts. These charts aid in understanding the Order Allocation System and its information flow. (300 pages)

LY20-0509 IBM System/360 OS 65
LEARN Administrative
Terminal System
System Manual

Program Number: 5734-XX8
Feature Code: 8053

This manual contains information on the design, logic flow, and coding of the OS LEARN ATS program. It describes the macros and programs that make up the system and includes program flowcharts of the new application programs to be incorporated into the existing Administrative Terminal System. (32 pages)

LY20-0510 IBM System/360 DOS 65
LEARN Administrative
Terminal System
System Manual

Program Number: 5736-XX3
Feature Code: 8054

This manual contains information on the design, logic flow, and coding of the DOS LEARN ATS program. It describes the macros and programs that make up the system and includes program flowcharts of the new application programs to be incorporated into the existing Administrative Terminal System. (32 pages)

LY20-0528 OS/360 Inventory Control 65
System Manual

Program Number: 5734-M52
Feature Code: 8011

OS/360 Inventory Control consists of seven programs specially designed for implementing order point inventory control in manufacturing organizations.

This manual provides detailed information to assist the user in obtaining a more thorough knowledge of the program logic employed in the programs.

The manual includes program flowcharts and flowchart narratives, in addition to information regarding switches, labels, symbols, and register assignment. (108 pages)

GY20-0529 CALL/360 - OS Executive 60
and Utilities System Manual

Program Number: 360A-CX-42X

This publication describes the internal logic of the executive and utility programs for the CALL/360-OS system. This system is a personal time sharing computing system, which can be run in either an MFT or MVT environment.

The executive program controls the work in the partition or region assigned to CALL/360-OS. It contains facilities for interrupt handling, terminal and direct access data management, command processing, and debugging.

The utility programs provide facilities for system build, job initialization, data base management, and accounting. These programs are used by programmers responsible for maintaining the system and its data base.

Also included in this publication are the macro instructions, data formats, and character sets used by CALL/360-OS. (824 pages)

GY20-0530 CALL/360-OS Basic 60
System Manual

Program Number: 360A-CX-42X

This manual provides detailed information on the routines which make up the BASIC compiler for CALL/360-OS. These routines are used to compile and execute a BASIC source program. This manual can be used to locate specific areas of the program, and it enables the reader to relate these areas to the corresponding program listings. (568 pages)

GY20-0531 CALL/360-OS 60
FORTRAN System Manual

Program Number: 360A-CX-42X

This publication describes the internal logic of the CALL/360-OS FORTRAN compiler which transforms source statements written in the CALL/360-OS FORTRAN language into object programs for immediate execution. The manual is intended primarily for use by IBM personnel involved in program design and maintenance; it is not required for normal use or operation of the program described.

The systems manual begins with a comprehensive survey of the CALL/360-OS FORTRAN Compiler which defines the compiler and its relationship to the CALL/360-OS time-sharing system. The overall method of compiler operation is then treated, followed by a detailed discussion of the segmentation of the compiler into a translation and code generation phase (Phase I), a linking loader phase (Phase II), and an execution phase (Phase III). For convenience, logical flowcharts of most complex compiler operations are in a separate section. Additional material covering the POP macro programming language, routine directory, lists and tables, intermediate code, SVC and register usage, and diagnostic messages is provided in an appendix. (344 pages)

LY20-0535 System/360 Capacity 65
Planning-Infinite Loading
System Manual

Program Number: 5736-M11
Feature Code: 8021

System/360 Capacity Planning consists of programs designed to plan the capacity required for a production plan, and to schedule orders based on available production facilities.

Its main application area is in job shops where production facilities are used intermittently to perform production or assembly operations on different items.

This manual provides detailed information to assist the user in obtaining a more thorough knowledge of the logic employed in the programs. It contains information on the system design, logic flow, and coding of the programs. It is intended chiefly for system programmers and system engineers. (92 pages)

LY20-0536 System/360 Capacity 65
Planning—Finite Loading
System Manual

Program Number: 5736-M12
Feature Code: 8022

System/360 Capacity Planning consists of programs designed to plan the capacity required for a production plan, and to schedule orders on the basis of available production facilities.

Its main application area is in job shops where production facilities are used intermittently to perform production or assembly operations on different items.

This manual provides detailed information to assist the user in obtaining a more thorough knowledge of the logic employed in the programs. It contains information on the system design, logic flow, and coding of the programs and is intended chiefly for system programmers and system engineers. (236 pages)

LY20-0537 System/360 Requirements 65
Planning Interface
System Manual

Program Number: 5736-M13
Feature Code: 8023

System/360 Requirements Planning Interface is a program product which, when added to System/360 Requirements Planning (360A-MF-05X), provides the ability to generate connection records. The connection file is required by System/360 Capacity Planning—Finite Loading (5736-M12).

This manual includes flowcharts, flowchart narratives, and listings of the macros that constitute the program product.

The information in this manual is intended for use by system programmers in conjunction with *System/360 Requirements Planning, System Manual (GY20-0317)*. (20 pages)

LY20-0543 OS/360 Requirements 65
Planning System Manual

Program Number: 5734-M51
Feature Code: 8010

The OS/360 Requirements Planning programs are used to generate material requirements for finished products, assemblies, subassemblies, parts, and raw materials based upon an input of a forecast and/or orders. OS/360 Requirements Planning consists of three components: requirements generation program, print exception program, and chained file management system. The requirements generation

program performs the generation of requirements, utilizing time series planning to determine gross requirements, determine net requirements, plan orders, determine offset, and post component gross requirements. The print exception program prints the notices for the exceptions discovered during the requirements generation run. The chained file management system creates and maintains a centralized manufacturing information system.

This manual includes program flowcharts and flowchart narratives, in addition to information regarding switches, labels, symbols, and register assignment. The manual is intended to aid systems analysts and programmers install and maintain OS/360 Requirements Planning. (552 pages)

LY20-0546 System/360 Power System 31
Planning (PSP) for the Electric Utility
Industry Power Flow System Manual—
Volume III

Program Number: 5736-U12
Feature Code: 8172

The Power System Planning (PSP) Program Product package is designed specifically for System/360. The package uses disk storage to provide the capability of establishing a master data bank of repeatedly used engineering data that describes an electrical network. The package further provides the convenience of automatic data retrieval from the master data bank whenever a simulation program is to be run. In order to study the steady-state and transient operational characteristics of present and projected interconnected power networks, three digital simulation components are included in the package—Power Flow, Short Circuit, and Transient Stability.

This manual is designed for use by the system analyst and system programmer. It describes the basic solution technique and its implementation in the Power Flow simulation component. Power Flow files and variables are described. The format of the results file, which may be saved upon completion of a Power Flow simulation, is described. In addition, a description of each procedure in the Power Flow component is given. (128 pages)

LY20-0553 System/360 Power 31
System Planning (PSP) for the
Electric Utility Industry Short
Circuit System Manual—Volume II

Program Number: 5736-U12
Feature Code— 8174

The Power System Planning (PSP) Program Product package is designed specifically for the IBM System/360. The package uses disk storage to establish a master data bank of repeatedly used engineering data that describes an electrical network. The package further provides the convenience of automatic data retrieval from the master data bank whenever a simulation program is to be run. In order to study the steady-state and transient operational characteristics of present and projected interconnected power networks, three digital simulation components are included in the package—power flow, short circuit, and transient stability.

This manual is designed for use by the system analyst and system programmer. It describes the basic solution technique and its implementation in

the short circuit component. Files and variables are described. The format of the results file, which may be saved upon completion of the input phase of a short circuit simulation study, is described. A description of each procedure in the short circuit component is given. (332 pages)

LY20-0554 System/360 Power System 31
Planning (PSP) for the Electric Utility
Industry Transient Stability
System Manual—Volume IV

Program Number: 5736-U12
Feature Code: 8173

The Power System Planning (PSP) Program Product package is designed specifically for the IBM System/360. The package uses disk storage to make it possible to establish a master data bank of repetitively used engineering data that describes an electrical network. The package provides the further convenience of automatic data retrieval from the master data bank whenever a simulation program is to be run. In order to study the steady-state and transient operational characteristics of present and projected interconnected power networks, three digital simulation components are included in the package: power flow, short circuit, and transient stability.

This manual is designed for use by the system analyst and system programmer. It describes the basic solution technique and its implementation in the transient stability simulation component. Files and variables are described. The format of the results file generated during a transient stability simulation study is described. In addition, a description of each procedure in the transient stability component is given. (128 pages)

LY20-0555 System/360 Power System 31
Planning (PSP) for the Electric Utility
Industry Engineering Data Management
Services System Manual—Volume I

Program Number: 5736-U12
Feature Code: 8174

The Power System Planning (PSP) Program Product package is designed specifically for the IBM System/360. The package uses disk storage to provide the capability of establishing a master data bank of repeatedly used engineering data that describes an electrical network. The package further provides the convenience of automatic data retrieval from the master data bank whenever a simulation program is to be run. In order to study the steady-state and transient operational characteristics of present and projected interconnected power networks, three digital simulation components are included in the package—power flow, short circuit, and transient stability.

This manual is designed for use by the system analyst and system programmer. It describes the methods used in validating, reformatting, loading, updating, printing, and retrieving data from the master data bank maintained by the engineering data management service (EDMS) component. EDMS files and variables are described. In addition, a description of each procedure in the engineering data management service (EDMS) component is given. (128 pages)

- LY20-0559** **Tariff Publishing System** **65**
(Bound Tariffs) System Manual
Program Number: 5736-T21
Feature Code: 8003
This manual provides detailed information to assist system analysts and programmers in gaining a more thorough knowledge of the programming logic employed in this application. Included for each unit process subroutine, general purpose subroutine, and the mainline components are the flowchart narrative and the flowcharts. (402 pages)
- LY20-0560** **Traffic Profile Analysis** **65**
System, System Manual
Program Number: 5736-T22
Feature Code: 8004
This manual provides detailed information to help the user more thoroughly understand the programming logic employed in the application. Included for each program are the switches and registers used, the flowchart narrative and the flowcharts. (64 pages)
- LY20-0561** **Medical Information System** **65**
Program (MISP) Version 2 System
Manual
Program Number: 5736-H11
Feature Code: 8500
This manual contains the general and detailed flowcharts with narratives as necessary for the Medical Information Systems Program. The flowcharts are preceded by diagrams of both the interaction among executive program modules and techniques for construction of the application program. (384 pages)
- LY20-0565** **System/360 Shop Floor** **65**
Control System Manual
Program Number: 5736-M31
Feature Code: 8024
System/360 Shop Floor Control is a group of programs designed to provide current information about the manufacturing facility and to assist management in effectively controlling production. The programs provide for the release of orders to the manufacturing facility, the creation and maintenance of records pertaining to the orders, retrieval of orders, report capability on the status of the orders, and the preparation and printing of a work list for shop supervisory personnel.
This manual includes (1) flowcharts, (2) flowchart narratives, and (3) a list of the program switches used by System/360 Shop Floor Control. The audience for this manual includes customer operating personnel, systems analysts, and programmers. The prerequisite for the use of this manual is a knowledge of System/360 PL/I, System/360 Disk Operating System, and the Bill of Material Processor. (148 pages)
- LY20-0566** **System/360 Data Base** **65**
Organization and Maintenance
Processor System Manual
Program Number: 5736-XX4
Feature Code: 8036
This manual provides detailed information to assist the user in gaining a more thorough knowledge of the programming logic employed in the application.
It contains detailed reference material for the file organization, maintenance, and reorganization program modules. The audience for this manual is the systems programmer.
Core storage allocation for each module is dependent upon the options chosen by the user. These allocations may be found in the *System/360 Data Base Organization and Maintenance Processor, Program Description Manual* (SH20-0829) in section 3.30 entitled "Core Storage Requirements".
Program modification is achieved through the customization of the supplied source code by means of user-supplied parameters. Customizing is discussed in the *System/360 Data Base Organization and Maintenance Processor, Program Description Manual* in section 5 entitled "Customizing the Data Base Organization and Maintenance Processor" and the Appendix entitled "Customizing the MAINLINE Module of Creation and Maintenance of the Four Basic Manufacturing Files".
Program listings are not included in this manual, as customization and assembly will provide the listings which correctly reflect the parameters chosen. (788 pages)
- GY20-0567** **Call/360-OS PL/I System** **60**
Manual—Volume I
Program Number: 360A-CX-42X
The CALL/360-OS PL/I compiler (to be used with the CALL/360-OS System on an IBM System/360 Model 50 or higher) is described in the four volumes of this publication. The publication is addressed to system programmers and customer engineers who require a detailed knowledge of the compiler. It contains a general overview of the compiler and detailed information on the compiler and runtime routines and macros that perform required functions. Additional information required to understand CALL/360-OS PL/I compiler operations is provided in several appendices.
Volume I contains a general description of the compiler, a section on compiler operations, and a directory to compiler routines. (472 pages)
- GY20-0568** **Call/360-OS PL/I System** **60**
Manual Volume II
Program Number: 360A-CX-42X
The CALL/360-OS PL/I compiler (to be used with the CALL/360-OS System on an IBM System/360 Model 50 or higher) is described in the four volumes of this publication. The publication is addressed to system programmers and customer engineers who require a detailed knowledge of the compiler. It contains a general overview of the compiler and detailed
- information on the compiler and runtime routines and macros that perform required functions. Additional information required to understand CALL/360-OS PL/I compiler operations is provided in several appendices.
Volume II contains information on runtime support modules and the first part of a directory to runtime routines. (168 pages)
- GY20-0569** **Call/360-OS PL/I System** **60**
Manual—Volume III
Program Number: 360A-CX-42X
The CALL/360-OS PL/I compiler (to be used with the CALL/360-OS System on an IBM System/360 Model 50 or higher) is described in the four volumes of this publication. The publication is addressed to system programmers and customer engineers who require a detailed knowledge of the compiler. It contains a general overview of the compiler and detailed information on the compiler and runtime routines and macros that perform required functions. Additional information required to understand CALL/360-OS PL/I compiler operations is provided in several appendices.
Volume III contains the remainder of the directory to runtime routines, consisting of the mathematical function package and aggregate manipulation package. (136 pages)
- GY20-0570** **Call/360-OS PL/I System** **60**
Manual—Volume IV
Program Number: 360A-CX-42X
The CALL/360-OS PL/I compiler (to be used with the CALL/360-OS System on an IBM System/360 Model 50 or higher) is described in the four volumes of this publication. The publication is addressed to system programmers and customer engineers who require a detailed knowledge of the compiler. It contains a general overview of the compiler and detailed information on the compiler and runtime routines and macros that perform required functions. Additional information required to understand CALL/360-OS PL/I compiler operations is provided in several appendices.
Volume IV contains appendices covering the following subjects:
Compiler conventions and data layout
Compiler tables and lists
Compiler support macros
Runtime support macros
Object code storage layout
Support services for language processors
CALL/360-OS PL/I Compiler maintenance
Diagnostic messages
Maximum size of source program
Reference listings
(244 pages)
- GY20-0575** **IBM System/360 DOS** **61**
Power II System Manual
POWER II (Priority Output Writers, Execution processors, and input Readers) is an automatic SPOOLING processor and priority scheduler for normal batch processing under IBM System/360 Disk Operating System. This manual describes the internal logic of POWER II. It includes

descriptive text, flowcharts, detailed breakdown of subroutines and macros, plus additional aids to debugging. This manual is intended for use in maintenance or modification of POWER II. (324 pages)

GY20-0576 IBM System/360 DOS Power II Remote Job Entry System Manual 61

IBM System/360 Power II Remote Job Entry (POWER II/RJE) offers the ability to submit jobs via remote IBM 2780 Data Transmission Terminals for normal batch processing under DOS. This manual describes the internal logic of POWER II RJE. It includes descriptive text, flowcharts, detailed breakdown of subroutines and macros, plus additional aids to debugging. This manual is intended for use in maintenance or modification of POWER II RJE. (190 pages)

LY20-0579 System/360 Agribusiness Management Information System, System Manual 65

*Program Number: 5736-D51
Feature Code: 8012*

The IBM Agribusiness Management Information System is a set of programs and procedures which make available financial, tax, and management information to the agribusiness industry. This manual provides detailed information about the Agribusiness Management Information System (AMIS) programs. The reader will be charged with maintenance of the system and should be familiar with IBM System/360 Disk Operating System (S/360 DOS) and with the AMIS programs. (386 pages)

LY20-0587 Property and Liability Information System (PALIS) Additional File Facility (2314) Systems Reference Manual 65

*Program Number: 5736-N22
Feature Code: 8007*

This reference publication describes the functions and logic of the new modules and changes to the PALIS Basic program (360A-IF-10X) that make up the PALIS Additional File Facility (2314) (5736-N22). Changes to the logic, preparation for use, and operation of rateload, file support, transaction edit, file maintenance run, and inquiry are included.

This manual must be used in conjunction with the *Property and Liability Information System (PALIS), Basic Program, Program Description and System Manual (GH20-0497)* and the *Property and Liability Information System (PALIS), Basic Program, Operations Manual (GH20-0498)*. (88 pages)

GY20-0590 Control Program-67/Cambridge Monitor System (CP-67/CMS) Version 3 CP-67 PLM 61

Program Number: 360D-05.2.005

This publication describes the internal logic of the CP-67 (Control Program-67) system. The

system consists of a Control Program that creates a multiprogramming, time-sharing environment by providing virtual machines for users to run their own operating systems concurrently with other users. This manual is directed to personnel who will be responsible for the maintenance and modification of CP-67. (300 pages)

GY20-0591 Control Program-67/Cambridge Monitor System (CP-67/CMS) Version 3 CMS Program Logic Manual 61

Program Number: 360D-05.2.005

The Cambridge Monitor System (CMS) is a conversational monitor system that provides a comprehensive, easy-to-use set of programs (commands) giving the CMS user a wide variety of functions, including the ability to create additional commands or subsystems to satisfy his special requirements.

This manual provides a detailed description of the internals of CMS. (520 pages)

LY20-0595 IBM System/360 Filing and Source Data Entry Techniques for Easier Retrieval-Low Core (FASTER LC) System Manual 65

*Program Number: 5736-G22
Feature Code: 8056*

This manual details the program logic of FASTER LC, discussing each system routine and its function within the basic components identified as Line Control, Interface, and Message Processor. Internal controls are described, and modification guidelines are provided, for the benefit of installation programmers or systems engineers. The information in this manual is not needed, ordinarily, by operations or applications personnel.

Data-control flowcharts, line-control flowcharts, and program listings are logical parts of this manual and are made available in machine-readable form. See the Application Directory for a description of the distribution medium. (92 pages)

LY20-0596 General Purpose Simulation System V-OS (GPSS V-OS) System Manual 65

*Program Number: 5734-XS2
Feature Code: 8101*

This publication contains a description of the internal structure and the basic operation of the GPSS program. All the modules which make up the GPSS program are discussed in general and, where appropriate, the operation of all routines within a given module is explained in detail.

The information contained in this manual should give the user a thorough understanding of the structure and operation of the GPSS program so that modifications may be more easily designed and implemented. (570 pages)

GY20-0597 Compatibility Operating System for Emulation of IBM 1410/7010 Data Processing Systems Operating on IBM System/360 Model 50 (COS/50) (360D-11.1.025) Program Logic Manual 61

This publication describes the internal logic of the Compatibility Operating System (COS/50). COS/50 is used with System/360 Compatibility Feature No. 4478, modified by RPQ F23666, to execute IBM 1410/7010 programs on an IBM System/360 Model 50. COS/50 operates as a problem program under the IBM System/360 Operating System.

This manual is intended for persons involved in program maintenance or system programmers who are altering the program design; it is not needed for normal use or operation of the program described. (60 pages)

LY20-0655 Shared Laboratory Information System (SLIS) System Manual 65

*Program Number: 5736-H12
Feature Code: 8005*

The IBM Shared Laboratory Information System (SLIS) provides data processing support for hospital clinical laboratories. Operating under the Shared Hospital Accounting System (SHAS) executive, the programs handle batched input of laboratory requisitions and test results, producing laboratory reports for use throughout the hospital.

The program design allows tailoring of formats and procedures to meet the separate needs of several hospitals sharing a common computer. Input and output of the system may, as an option, use the SHAS teleprocessing executive, allowing remote data entry and report production. The laboratory application programs complement the SHAS accounting application programs through the use of a common admission procedure and automatic charge generation.

This manual contains detailed program information useful for program modification, error diagnosis and maintenance. The manual contains detailed descriptive information on the logical operation of each program, through program flowcharts. Most flowchart narratives are general, but more detail has been included for the complicated programs. Labels and symbols, programmed switches, program indicators, register usage, special techniques, program modification notes, and service subprogram usage are defined for each system program.

This document is written as a reference manual. Before using this manual the reader should be thoroughly familiar with the following manuals: Shared Laboratory Information System Application Description Manual (GH20-0709), Shared Laboratory Information System Laboratory Manual (SH20-0769), Shared Laboratory Information System Program Description Manual (SH20-0780), Shared Laboratory Information System Operations Manual (SH20-0781). (284 pages)

PLM Note <i>Program Logic Manuals describe the internal design or logic of the subject programs. These manuals are intended for persons involved in program maintenance and system programmers who are altering the program design. Program logic information is not necessary for the operation of the program; therefore, distribution of these publications is limited to persons with maintenance and alteration requirements.</i>			
GY21-0001 IBM System/360 Basic Programming Support—FORTRAN IV (16K Card)—Program Logic Manual <i>Program Number: 360P-FO-205</i> "See PLM Note." (156 pages)	25		
GY21-0004 IBM System/360 Basic Programming Support Distribution Program—Program Logic Manual <i>Program Number: 360-UT-208</i> "See PLM Note." (40 pages) Effective use of this manual requires an understanding of the following IBM System/360 publications: <i>IBM System/360 Basic Programming Support, Distribution Program Specifications and Operating Guide</i> , Order Number GC21-5001; <i>IBM System/360 Principles of Operation</i> , Order Number GA22-6821.	32		
LY21-0012 IBM System/360 Operating System IBM 1419 Magnetic Character Reader IBM 1275 Optical Reader Sorter Device Dependent BSAM Program Logic Manual The internal logic of IBM 1419/1275 BSAM support for IBM System/360 Operating System is described in this PLM. It is designed for use by persons involved in program maintenance, and system programmers who are altering the program design. Program logic information is not necessary for the use and operation of this support. (76 pages)	30		
LY21-0013 IBM System/360 Operating System IBM 1285, 1287, and 1288 Optical Readers Program Logic Manual <i>Program Number: 360S-DM-508</i> This publication describes the internal program logic for the support of the IBM 1285, 1287, and 1288. The support includes modules to read documents with BSAM and journal tapes with QSAM. (104 pages)	30		
LY21-0021 IBM System/360 IBM 1288 Basic Unformatted Read System Program Logic Manual <i>Program Number: 5736-UT1</i> This publication describes the internal logic of the data capture program. This includes the following areas: • Method of operation • Program organization • Data area formats This manual is intended as a recall mechanism and a debugging aid. It does not include information necessary to implement the program. (88 pages)	32		
LY21-0022 IBM System/360 Operating System IBM 1288 Basic Unformatted Read System Program Logic Manual <i>Program Number: 5734-UT3</i> This PLM is written primarily for persons responsible for the maintenance of the program. It is intended as a recall mechanism and a debugging aid. As a debugging aid, this manual serves best as a guide to sequences of instruction found in the coding of the program. This publication describes the internal logic of the IBM 1288 Basic Unformatted Read System and includes the following items: • Method of Operation • Program Organization • Data Area Formats The information necessary to implement the program is not included in this publication. (88 pages)	32		
GY24-5000 IBM System/360 Basic Operating System Disk Assembler Program Logic Manual <i>Program Number: 360B-AS-309</i> This publication describes the internal logic of the IBM System/360 Basic Operating System, Disk Assembler Program. It is intended for use by persons involved in program maintenance and by system programmers who are altering the program design. Program logic information is not necessary for the operation of the Disk Assembler Program. The titles and abstracts of related publications are listed in the IBM SYSTEM/360 BIBLIOGRAPHY, Order No. GA22-6822. (672 pages)	21		
GY24-5001 IBM Basic Operating System/360 (8K Disk) Sort/Merge—Program Logic Manual <i>Program Number: 360B-SM-308</i> "See PLM Note." (390 pages)	33		
GY24-5002 IBM System/360 Basic Operating System—System Control—Program Logic Manual <i>Program Number: 360B-CL-302</i> "See PLM Note." (499 pages)	36		
GY24-5003 IBM System/360 Basic Operating System—Logical IOCS—Program Logic Manual <i>Program Numbers: 360B-IO-303 (Sections 1 and 2) 360B-IO-304 (Section 3) 360B-IO-305 (Section 4)</i> "See PLM Note." (321 pages)	30		
GY24-5005 IBM System/360 Basic Operating System—Report Program Generator (8K Disk)—Program Logic Manual <i>Program Number: 360B-RG-307</i> "See PLM Note." (408 pages)	28		
Y24-5006 IBM System/360 Basic Operating System—1070 Process Communication Supervisor—Program Logic Manual <i>Program Number: 360B-SV-032</i> "See PLM Note." (117 pages)	36		
GY24-5007 IBM System/360 Basic Programming Support Paper Document Program Logic Manual <i>Program Numbers: For IBM 1231-N1—360P-IO-060 (Version 2) For IBM 1418/1428—360P-IO-059 (Version 2) For IBM 1412/1419—360P-IO-058 (Version 3)</i> "See PLM Note." (183 pages)	30		
GY24-5009 IBM System/360 Operating System—COBOL-E—Program Logic Manual <i>Program Number: 360S-CO-503</i> "See PLM Note." (280 pages) This manual is designed to be used as a supplement to the program listing. Effective use requires an understanding of IBM System/360 operation and of IBM System/360 Operating System data management linkage editing, service programs, and COBOL language specifications. Reference publications for this information are listed in the Preface.	24		
GY24-5010 IBM System/360 Basic Programming Support—Basic Tape System (System Control and IOCS) Program Logic Manual <i>Program Number: 360P-40-046</i> "See PLM Note." (325 pages) This manual discusses the 8K Tape Control System (System Tape), 8K Independent Control System, and Logical and Physical IOCS supporting these systems.	36		

PLM Note

Program Logic Manuals describe the internal design or logic of the subject programs. These manuals are intended for persons involved in program maintenance and system programmers who are altering the program design. Program logic information is not necessary for the operation of the program; therefore, distribution of these publications is limited to persons with maintenance and alteration requirements.

**GY24-5011 IBM System/360
Basic Programming Support—
Tape Autotest Program
Logic Manual** 37

Program Number: 360P-PT-045

"See PLM Note." (For 8K Tape) (105 pages)

**GY24-5012 IBM System/360
Basic Programming Support—
Tape Assembler Program
Logic Manual** 21

Program Number: 360P-AS-091

"See PLM Note." (524 pages)

**GY24-5013 IBM System/360
Basic Programming Support—
Universal Character Set Utility—
Program Logic Manual** 32

"See PLM Note." (23 pages)

**GY24-5014 IBM System/360 Basic
Programming Support Basic Assembler,
Program Logic Manual** 21

Program Number: 360P-AS-021

Drop shipped to major users; minimal supply available at IBM Distribution Center to meet other requirements. This publication provides detailed information on the internal logic of the IBM System/360 Basic Programming Support Basic Assembler. It is intended for technical personnel who are responsible for analyzing program operation, diagnosing malfunctions, and/or adapting the program to special usage. Program logic information is not necessary for the operation of the program. (110 pages)

**GY24-5015 IBM System/360 Basic
Programming Support—Basic Utilities
Program Logic Manual** 32

"See PLM Note." (131 pages)

Programs included are:
Absolute Loader
Relocating Loader
Single-Phase Dump Program
Two-Phase Dump Program
I/O Support Package

**GY24-5016 IBM System/360
Tape Operating System—
Sort/Merge—Program Logic
Manual** 33

Program Number: 360M-SM-400

"See PLM Note." (218 pages)

**GY24-5017 IBM System/360 Disk
Operating System Introduction
to System Control Programs—
Program Logic Manual** 36

Program Number: 360N-CL-453, Version 3

"See PLM Note." (84 pages)

This is one of five program logic manuals that describe the internal logic of the IBM System/360 Disk Operating System system control programs:

*IBM System/360 Disk Operating System,
Introduction to System Control Programs,
Order Number GY24-5017.*

*IBM System/360 Disk Operating System, IPL
and Job Control Programs, Order Number
GY24-5086.*

*IBM System/360 Disk Operating System, Super-
visor and Physical and Logical Transients,
Order Number GY24-5084.*

*IBM System/360 Disk Operating System,
Librarian Maintenance and Service Programs,
Order Number GY24-5079.*

*IBM System/360 Disk Operating System,
Linkage Editor, Order Number GY24-5080.*

These manuals are designed to be used as a supplement to the program listing, and their effective use requires an understanding of IBM System/360 operation and of IBM System/360 Disk Operating System control and service programs, macro instructions, and operating procedures. Reference publications for this information are listed in the Preface of this manual.

**GY24-5018 IBM System/360 Tape
Operating System—Logical IOCS—
Program Logic Manual** 30

Program Number: 360M-IO-404, Version 2.1

"See PLM Note." (320 pages)

Effective use of this publication requires an understanding of the following IBM System/360 publications:

*IBM System/360 Principles of Operation,
Order Number GA22-6821*

*IBM System/360 Disk and Tape Operating
Systems, Assembler Specifications, Order
Number GC24-3414*

*IBM System/360 Tape Operating System, Sys-
tem Control, Order Number GY24-5022*

Other related publications are listed in the Preface.

**GY24-5019 IBM System/360 Tape
Operating System Utility Programs** 32

Program Number: 360M-UT-403

This publication describes the internal logic of the IBM System/360 Tape Operating System Utility programs. It is intended for use by persons involved in program maintenance, and system programmers who are altering the program design. Program logic information is not necessary for the operation of the program. (148 pages)

**GY24-5020 IBM System/360 Disk
Operating System Logical IOCS,
Volume 1: Introduction—
Program Logic Manual** 30

Program Numbers:

CPMOD 360N-CL-453

CPMOD 360N-CL-453

DAMOD 360N-IO-454

DIMOD 360N-CL-457

DTFN 360N-CL-453

ISMOD 360N-IO-457

MROM 360N-IO-477

MTMOD 360N-IO-456

ORMOD 360N-IO-478

PRMOD 360N-CL-453

PTMOD 360N-IO-458

SDMOD 360N-IO-455

"See PLM Note." (309 pages)

This reference publication is one of four Program Logic Manuals that describe the internal logic of the Logical IOCS (Input-Output Control System) programs for the IBM System/360 Disk Operating System. The four related Program Logic Manuals are:

*Volume 1: Introduction, Order Number
GY24-5020.*

*Volume 2: Unit Record, Magnetic Tape, and
Device Independent Files, Order Number
GY24-5087.*

*Volume 3: Sequential and Direct Access DASD
Files, Order Number GY24-5088.*

*Volume 4: Indexed Sequential File Management
System, Order Number GY24-5089.*

Effective use of this publication requires an understanding of IBM System/360 operation and the Disk Operating System Assembler language and its associated macro definition language. Reference publications for this information are listed in the Preface.

For a list of associated publications and their abstracts, see *IBM System/360 Bibliography*, Order Number GA22-6822.

**GY24-5021 IBM System/360 Disk
Operating System—Sort/Merge—
Program Logic Manual** 33

Program Number: 360N-SM-450

"See PLM Note." (380 pages)

**GY24-5022 IBM System/360 Tape
Operating System—System Control—
Program Logic Manual** 36

Program Number: 360M-CL-405, Version 2

"See PLM Note." (624 pages)

This manual is designed to be used as a supplement to the program listings. Effective use requires an understanding of IBM System/360 operation and of IBM System/360 Tape Operating System assembler language, macro-instructions, and system control and maintenance program operation. Reference publications for this information are listed in the Preface.

PLM Note

Program Logic Manuals describe the internal design or logic of the subject programs. These manuals are intended for persons involved in program maintenance and system programmers who are altering the program design. Program logic information is not necessary for the operation of the program; therefore, distribution of these publications is limited to persons with maintenance and alteration requirements.

GY24-5023 IBM System/360 Disk Operating System—Utilities—Program Logic Manual 32

Program Numbers:
360N-UT-461
360N-UT-462
360N-UT-463

“See PLM Note.” (222 pages)

GY24-5025 IBM System/360 Disk and Tape Operating Systems—COBOL-D with DASD Macros—Program Logic Manual 24

Program Numbers:
360M-CB-402
360M-CB-452

“See PLM Note.” (131 pages)

This manual is designed to be used as a supplement to the program listing.

GY24-5026 IBM System/360 Tape Operating System Autotest Program Logic Manual 37

This publication describes the internal logic of the IBM System/360 Tape Operating System Autotest program. It is intended for use by persons involved in program maintenance, and system programmers who are altering the program design. Program logic information is not necessary for the operation of the program. Therefore, distribution of this publication is limited to those with maintenance and alteration requirements. (225 pages)

GY24-5027 IBM System/360 Disk Operating System—Autotest—Program Logic Manual 37

Program Number: 360N-PT-459

“See PLM Note.” (429 pages)

GY24-5032 IBM System/360 Disk and Tape Operating Systems—FORTRAN IV—Program Logic Manual 25

Program Numbers:
360M-FO-409
360N-FO-451

“See PLM Note.” (151 pages)

GY24-5037 IBM System/360 Basic Programming Support Report Program Generator for Punched Card Equipment Program Logic Manual 28

Program Number: 360P-RG-200

“See PLM Note.” (296 pages)

Effective use of this manual requires an understanding of IBM System/360 operation and of IBM System/360 Tape Operating System assembler language, macro instructions, and system control and maintenance program operation. Reference publications for this information are listed in the Preface of this manual.

Titles and abstracts of other related publications are listed in the *IBM System/360 Bibliography*, Order Number GA22-6822.

GY24-5045 IBM System/360 Disk and Tape Operating System Utility Macros Program Logic Manual 32

Program Numbers:
360N-UT-471
360M-UT-411

“See PLM Note.” (112 pages)

These utility macros support file-to-file operations among the following devices:

IBM 2501 Card Reader
IBM 1442 Card Read Punch
IBM 2520 Card Read Punch
IBM 2540 Card Read Punch
IBM 1052 Printer-Key-board
IBM 1403 Printer
IBM 1404 Printer (continuous forms only)
IBM 1443 Printer
IBM 1445 Printer
IBM 2311 Disk Storage Drive (DOS/360)
IBM 2314 Direct Access Storage Facility (DOS/360)

IBM 2495 Tape Cartridge Reader (DOS/360)
IBM 2400-Series Magnetic Tape Unit. For tape input and/or output, the utility macros require the optional Supervisor “set mode” facility.

Effective use of this publication requires an understanding of IBM System/360 operating principles, and of the IBM System/360 Disk and Tape Operating Systems. Reference publications for this information are listed in the Preface of this publication.

Titles and abstracts of other related publications are listed in the *IBM System/360 Bibliography*, Order Number GA22-6822.

GY24-5056 IBM System/360 Disk and Tape Operating Systems On-Line Test Executive Program, Program Logic Manual 37

Program Numbers: 360N-DN-481-DOS
360M-DN-418-TOS

This publication describes the internal logic of the IBM System/360 Disk and Tape Operating Systems, On Line Test Executive Program (OLTEP). It is intended for use by persons involved in program maintenance and by system programmers who are

altering the program design. Program logic information is not necessary for the operation and use of the system; therefore, distribution is limited to those with maintenance and alteration requirements. (76 pages)

GY24-5079 IBM System/360 Disk Operating System Librarian Maintenance and Service Programs—Program Logic Manual 31

Program Number: 360N-CL-453, Version 3

“See PLM Note.” (220 pages)

Effective use of this manual requires an understanding of IBM System/360 operation and of IBM System/360 Disk Operating System control and service programs, macro instructions, and operating procedures. Reference publications for this information are listed in the Preface of this manual.

For overall system control logic description, this PLM is to be used with four other PLMS:

IBM System/360 Disk Operating System, Introduction to System Control and Service Programs, Order Number GY24-5017.

IBM System/360 Disk Operating System, IPL and Job Control Programs, Order Number GY24-5086.

IBM System/360 Disk Operating System, Supervisor and Physical and Logical Transients, Order Number GY24-5084.

IBM System/360 Disk Operating System, Linkage Editor, Order Number GY24-5080.

GY24-5080 IBM System/360 Disk Operating System Linkage Editor—Program Logic Manual 31

Program Number: 360N-CL-453, Version 3

“See PLM Note.” (108 pages)

Effective use of this manual requires an understanding of IBM System/360 operation and of IBM System/360 Disk Operating System control and service programs, macro instructions, and operating procedures. Reference publications for this information are listed in the Preface of this manual.

For overall system control logic description, this PLM is to be used with four other PLMS:

IBM System/360 Disk Operating System, Introduction to System Control Programs, Order Number GY24-5017.

IBM System/360 Disk Operating System, IPL and Job Control Programs, Order Number GY24-5086.

IBM System/360 Disk Operating System, Supervisor and Physical and Logical Transients, Order Number GY24-5084.

IBM System/360 Disk Operating System, Librarian Maintenance and Service Programs, Order Number GY24-5079.

PLM Note

Program Logic Manuals describe the internal design or logic of the subject programs. These manuals are intended for persons involved in program maintenance and system programmers who are altering the program design. Program logic information is not necessary for the operation of the program; therefore, distribution of these publications is limited to persons with maintenance and alteration requirements.

GY24-5084 IBM System/360 Disk 36
Operating System Supervisor and Physical and Logical Transients—Program Logic Manual

Program Number: 360N-CL-453, Version 3

“See PLM Note.” (332 pages)

Effective use of this manual requires an understanding of IBM System/360 operation and of IBM System/360 Disk Operating System control and service programs, macro instructions, and operating procedures. Reference publications for this information are listed in the Preface.

For overall system control logic description, this PLM is to be used with four other PLMS:
IBM System/360 Disk Operating System, Introduction to System Control Programs, Order Number GY24-5017.

IBM System/360 Disk Operating System, Librarian Maintenance and Service Programs, Order Number GY24-5079.

IBM System/360 Disk Operating System, Linkage Editor, Order Number GY24-5080.

IBM System/360 Disk Operating System, IPL and Job Control Programs, Order Number GY24-5086.

GY24-5086 IBM System/360 Disk 36
Operating System IPL and Job Control Programs Program Logic Manual

Program Number: 360N-CL-453

“See PLM Note.” (196 pages)

Effective use of this manual requires an understanding of IBM System/360 operation and of IBM System/360 Disk Operating System control and service programs, macro instructions, and operating procedures. Reference publications for this information are listed in the Preface.

For overall system control logic description, this PLM is to be used with four other PLMS:
IBM System/360 Disk Operating System, Introduction to System Control and Service Programs, Order Number GY24-5017.

IBM System/360 Disk Operating System, Supervisor and Physical and Logical Transients, Order Number GY24-5084.

IBM System/360 Disk Operating System, Librarian Maintenance and Service Programs, Order Number GY24-5079.

IBM System/360 Disk Operating System, Linkage Editor, Order Number GY24-5080.

GY24-5087 IBM System/360 Disk 30
Operating System Logical IOCS—Volume 2: Unit Record, Magnetic Tape, and Device Independent Files—Program Logic Manual

Program Numbers:

CDMOD 360N-IO-453, Version 3

CPMOD 360N-CL-453, Version 3

DIMOD 360N-CL-457, Version 3

DTFNC 360N-CL-453, Version 3

MRMOD 360N-IO-477, Version 3

MTMOD 360N-IO-456, Version 3

ORMOD 360N-IO-478, Version 3

PRMOD 360N-CL-453, Version 3

PTMOD 360N-IO-458, Version 3

“See PLM Note.” (308 pages)

This is one of four program Logic Manuals that describe the internal logic of the Logical IOCS (Input/Output Control System) programs for the IBM System/360 Disk Operating System. The four related Program Logic Manuals are:

Volume 1: Introduction, Order Number GY24-5020.

Volume 2: Unit Record, Magnetic Tape, and Device Independent Files, Order Number GY24-5087.

Volume 3: Sequential and Direct Access DASD Files, Order Number GY24-5088.

Volume 4: Indexed Sequential File Management System, Order Number GY24-5089.

Effective use of this publication requires an understanding of IBM System/360 operation and the Disk Operating System Assembler language and its associated macro definition language. Reference publications for this information are listed in the Preface.

GY24-5088 IBM System/360 Disk 30
Operating System Logical IOCS—Volume 3: Sequential and Direct Access DASD Files—Program Logic Manual

Program Numbers:

SDMOD 360N-IO-455, Version 3

DAMOD 360N-IO-454, Version 3

“See PLM Note.” (236 pages)

This is one of four Program Logic Manuals that describe the internal logic of the Logical IOCS (Input/Output Control System) programs for the IBM System/360 Disk Operating System. The four related Program Logic Manuals are:

Volume 1: Introduction, Order Number GY24-5020.

Volume 2: Unit Record, Magnetic Tape and Device Independent Files, Order Number GY24-5087.

Volume 3: Sequential and Direct Access DASD Files, Order Number GY24-5088.

Volume 4: Indexed Sequential File Management System, Order Number GY24-5089.

Effective use of this publication requires an understanding of IBM System/360 operation and the Disk Operating System Assembler language and its associated macro definition language. Reference publications for this information are listed in the Preface.

GY24-5089 IBM System/360 Disk 30
Operating System Logical IOCS—Volume 4: Indexed Sequential File Management System Program Logic Manual

Program Number: ISMOD 360N-IO-457, Version 3

“See PLM Note.” (336 pages)

This publication is one of four Program Logic Manuals that describe the internal logic of the Logical IOCS (Input/Output Control System) programs for the IBM System/360 Disk Operating System. The four related Program Logic Manuals are:

Volume 1: Introduction, Order Number GY24-5020.

Volume 2: Unit Record, Magnetic Tape and Device Independent Files, Order Number GY24-5087.

Volume 3: Sequential and Direct Access DASD Files, Order Number GY24-5088.

Volume 4: Indexed Sequential File Management System, Order Number GY24-5089.

Effective use of this publication requires an understanding of IBM System/360 operation and the Disk Operating System Assembler language and its associated macro definition language. Reference publications for this information are listed in the Preface.

For the titles and abstracts of other related publications, refer to the *IBM System/360 Bibliography*, Order Number GA22-6822.

GY24-5096 IBM System/360 Basic 32
Programming Support Modular File Maintenance Program Program Logic Manual

Program Number: 360P-UT-219

“See PLM Note.” (32 pages)

GY24-5151 IBM System/360 Disk 36
Operating System Supervisor and Physical Transients

This reference publication describes the internal logic of the IBM System/360 Disk Operating System, Supervisor and Physical Transients Programs. It is for persons involved in program maintenance and system programmers who are altering the program design. Program logic information is not needed for normal operation of these programs. This publication is a supplement to the program listing.

Effective use of this manual requires an understanding of IBM System/360 operation and of IBM System/360 Disk Operating System control and service programs, macro instructions, and operating procedures. Reference publications for this information are listed in the *Preface* of this manual. (336 pages)

GY24-5152 IBM System/360 Disk 36
Operating System Logical Transient Programs

This reference publication describes the internal logic of the IBM System/360 Disk Operating System, Logical Transient Programs. It is for

PLM Note

Program Logic Manuals describe the internal design or logic of the subject programs. These manuals are intended for persons involved in program maintenance and system programmers who are altering the program design. Program logic information is not necessary for the operation of the program; therefore, distribution of these publications is limited to persons with maintenance and alteration requirements.

persons involved in program maintenance and by system programmers who are altering the program design. Program logic information is not needed for normal operation of these programs. This publication is a supplement to the program listing.

Effective use of this manual requires an understanding of IBM System/360 operation and of IBM System/360 Disk Operating System control and service programs, macro instructions, and operating procedures. Reference publications for this information are listed in the *Preface* of this manual. (228 pages)

GY24-5153: IBM System/360 Disk Operating System, System Service Programs 36

This reference publication describes the internal logic of supervisor-interrelated service programs of the IBM System/360 Disk Operating System.

This manual is intended for persons involved in program maintenance and for system programmers altering the program design. Program logic information is not needed for normal use or operation of the system control program. It is designed as a supplement to the program listing.

Its effective use requires an understanding of IBM System/360 operation and of IBM System/360 Disk Operating System control and service programs, macro instructions, and operating procedures. Reference publications for this information are listed in the *Preface* of this manual. (196 pages)

GY26-3598 IBM System/360 Operating System Assembler (32K)—Program Logic Manual 21

“See PLM Note.” (123 pages)

GY26-3642 IBM System/360 Disk and Tape Operating Systems Assembler 21

*Program Numbers: 360N-AS-465-DOS
360M-AS-465-TOS*

This publication describes the internal logic of the D Assembler for the IBM System/360 Disk and Tape Operating Systems. It is intended for use by persons involved in program maintenance, and by systems programmers who are altering the program design. (138 pages)

GY26-3700 IBM System/360 Operating System Assembler (F) Program Logic Manual 21

Program Number: 360S-AS-037

This publication describes the internal logic of the F Assembler for the IBM System/360 Operating System. It is intended for use by persons involved in program maintenance and by system programmers who are altering the program design. (120 pages)

GY26-3701 IBM System/360 Disk and Tape Operating Systems—Report Program Generator—Program Logic Manual 28

*Program Numbers:
360N-RG-460 (Disk)
360M-RG-408 (Tape)*

“See PLM Note.” (130 pages)

GY26-3704 IBM System/360 Operating System Report Program Generator—Program Logic Manual 28

Program Number: 360S-RG-038

“See PLM Note.” (129 pages)

GY26-3716 IBM System/360 Disk Operating System Assembler (F) Program Logic Manual 21

Program Number: 360N-AS-466

This publication describes the internal logic of the F (64K) Assembler for the IBM System/360 Disk Operating System. It is intended for use by persons involved in program maintenance and by system programmers who are altering the program design. Since program logic information is not necessary for the use and operation of the Assembler, distribution of this publication is limited to these people. (118 pages)

LY26-3760 IBM System/360 Operating System Assembler H Program Logic Manual 21

This publication describes the internal logic and operation of Assembler H running under the IBM System/360 Operating System. In addition to descriptive text, this publication contains detailed flowcharts, figures showing the formats of internal tables and data areas, a microfiche directory, and a number of appendixes containing related reference information.

Program Logic Manuals are intended for IBM customer engineers concerned with program maintenance or alteration, and system programmers concerned with system design.

The reader should be familiar with the IBM System/360 Operating System and with the functions of an assembler. (320 pages)

SY26-3766 IBM 2740/2968 Audio-Visual Control Program Logic Manual RPQ Number F30209 36

This publication describes the program logic necessary to maintain the au (audio) and fp (visual) functions. The au and fp functions support the attachment of a 2968, Model 11, audio-visual control unit to a 2740, Model 1, remote terminal. The 2968 controls a non-IBM tape recorder and slide projector used with the 2740 terminal.

The manual is for customer engineers, field engineers, or others maintaining the au and fp programs. Program logic information pertaining to the 2968 control unit is in *IBM Model 11 Audio/Visual Control, Component Description and Operating Procedures*, Order Number GA26-1593. (46 pages)

GY27-7103 IBM System/360 Conversion Aids: The 1401/1460 Emulator Program for IBM System/360 Model 40—Program Logic Manual 35

Program Number: 360C-EU-074

“See PLM Note.” (51 pages)

The relationship of the program logic to that of the IBM 1401/1460 Compatibility Feature (#4457) is included.

GY27-7108 IBM System/360 Transition Aids: COBOL Language Conversion Program (1401-CB-701) for the IBM 1401 Program Logic Manual 24

This publication describes the internal logic of the COBOL Language Conversion Program for the IBM 1401, which is used as a transition aid to IBM System/360. It is intended for use by persons involved in program maintenance and system programmers who are altering the program design. Program logic information is not necessary for the use and operation of the program; therefore, distribution of this publication is limited to those with the aforementioned requirements. (92 pages)

GY27-7110 IBM System/360 Operating System Graphics Problem Oriented Routines Program Logic Manual 30

Program Number: 360S-IO-523

“See PLM Note.” (39 pages)

This manual covers routines intended for use with the IBM 2250 Display Unit. Its primary purpose is to serve as a guide to the program listings with which it is used.

PLM Note

Program Logic Manuals describe the internal design or logic of the subject programs. These manuals are intended for persons involved in program maintenance and system programmers who are altering the program design. Program logic information is not necessary for the operation of the program; therefore, distribution of these publications is limited to persons with maintenance and alteration requirements.

GY27-7111 IBM System/360 35
Conversion Aids: The 7074 Emulator Program for IBM System/360 Models 50 and 65—Program Logic Manual

Program Number: 360C-EU-725

“See PLM Note.” (74 pages)

This publication describes the internal logic of the IBM 7074 Emulator Program in conjunction with the IBM 7074 Compatibility Feature and is primarily a guide to the program listing.

GY27-7112 IBM System/360 35
Conversion Aids: The 7080 Emulator Program for IBM System/360 Model 65—Program Logic Manual

Program Number: 360C-EU-727

“See PLM Note.” (73 pages)

This publication is intended to be used with the program assembly listing and is primarily a guide to that listing.

GY27-7113 IBM System/360 30
Operating System Graphics Access Method—Program Logic Manual

Program Number: 360S-IO-523

“See PLM Note.” (92 pages)

This publication describes the operation of the Graphics Access Method (GAM) for the IBM 2250 Display Unit Models 1, 2, and 3, the IBM 2260 Display Station (Local Attachment); and the IBM 2280/82 Film Units. The Graphics Access Method functions in both express and basic environments, and both types of routines are described herein.

GY27-7115 IBM System/360 35
Conversion Aids: The 1410/7010 Simulator for IBM System/360—Program Logic Manual

Program Number: 360C-SI-754

“See PLM Note.” (98 pages)

GY27-7116 IBM System/360 35
Conversion Aids: The 1620 Simulator for IBM System/360 Program Logic Manual

Program Number: 360C-SI-752

“See PLM Note.” (85 pages)

GY27-7117 IBM System/360 35
Conversion Aids: The 7070/7074 Simulator for IBM System/360—Program Logic Manual

Program Number: 360C-SI-753

“See PLM Note.” (103 pages)

GY27-7118 IBM System/360 35
Conversion Aids: The 7080 Simulator for IBM System/360 Program Logic Manual

Program Number: 360C-SI-751

“See PLM Note.” (102 pages)

GY27-7119 IBM System/360 35
Conversion Aids: The 7090/7094 Simulator for IBM System/360—Program Logic Manual

Program Number: 360C-SI-750

“See PLM Note.” (95 pages)

GY27-7126 IBM System/360 35
Model 30—1620 Emulator Program—Program Logic Manual

Program Number: 360C-EU-731

“See PLM Note.” (79 pages)

GY27-7128 IBM System/360 36
Operating System Control Program with MFT—Program Logic Manual

Program Numbers:

360S-CI-505

360S-DM-508

“See PLM Note.” (88 pages)

This publication describes the internal logic of the control program to the extent that it is modified for MFT. These modifications affect the job management, task management, and data management routines of the control program.

GY27-7152 IBM System/360 25
Operating System Graphic Programming Services for FORTRAN IV—Program Logic Manual

Program Number: 360S-LM-537

“See PLM Note.” (132 pages)

GSP is a program that enables a FORTRAN programmer to write graphic programs for use with the IBM 2250 Display Unit in association with the IBM System/360 Operating System. It is not an extension of FORTRAN IV, but does extend graphic capabilities via subroutines and functions to the FORTRAN programmer. GSP may also be used in an assembler language program.

GY27-7155 IBM System/360 Operating 31
System Machine Check Handler for IBM System/360 Model 65 Program Logic Manual

The Machine-Check Handler reduces the number and minimizes the impact of unscheduled system interruptions resulting from machine-check interruptions in multiprogramming environments of the IBM System/360 Operating System. The program is designed for use with the uniprocessing and multiprocessing (partitioned or multisystem modes) systems of the IBM System/360 Model 65 only. This publication describes the program logic associated with the Machine-Check Handler error recovery operations. (77 pages)

GY27-7159 IBM System/360 36
Operating System Graphic Job Processor Support—Program Logic Manual

Program Number: 360S-RC-541

“See PLM Note.” (190 pages)

This publication describes the internal logic of the Graphic Job Processor (GJP) and the Graphics Interface Task (GFX), which are features of the IBM System/360 Operating System that permit jobs to be defined and initiated by responding to frames displayed on an IBM 2250 Display Unit.

GY27-7161 IBM System/360 25
Operating System and 1130 Disk Monitor System—System/360-1130 Data Transmission for FORTRAN Program Logic Manual

Program Numbers:

360S-LM-542

1130-LM-011

“See PLM Note.” (132 pages)

The PTOP subroutines enable a FORTRAN programmer to transmit data between a program being processed in the IBM System/360 Operating System and a program being processed in the IBM 1130 Disk Monitor System Version 2. The telecommunication capabilities provided are similar to those available to an Assembler Language programmer using the binary synchronous communications services of the Basic Telecommunications Access Method in the System/360 and the Synchronous Communications Adapter subroutine for point-to-point operations in the 1130. Although designed specifically for FORTRAN IV, the PTOP routines can also be used in an Assembler Language program.

GY27-7164 IBM System/360 Disk 35
Operating System 1401/1440/1460 Emulator Program Compatibility Support/30 Program Logic Manual

Program Number: 360N-EU-484

“See PLM Note.” (132 pages)

Compatibility Support/30 comprises the IBM 1401/1440/1460 Emulator Program for the Model 30, the IBM 1401/1440/1460 Basic Compatibility

PLM Note

Program Logic Manuals describe the internal design or logic of the subject programs. These manuals are intended for persons involved in program maintenance and system programmers who are altering the program design. Program logic information is not necessary for the operation of the program; therefore, distribution of these publications is limited to persons with maintenance and alteration requirements.

Feature, and the IBM Programmed Mode Switch Subfeature. The relationship of the program logic to that of the Basic Compatibility Feature and the Programmed Mode Switch is discussed, and the interface with the Disk Operating System, described. This publication is written as a guide to and for use with the program listing.

GY27-7165 IBM System/360 Disk 35
Operating System 1401/1440/1460
Emulator Program Compatibility
Support/40 Program Logic Manual

Program Number: 360N-EU-485

“See PLM Note.” (160 pages)

This publication describes the internal logic of the IBM 1401/1440/1460 Emulator Program under the Disk Operating System. The relationship of Compatibility Support/40 to the IBM 1401/1460 Compatibility Feature (#4457), the IBM 1311 Disk Compatibility Feature (#9710), and the IBM 1401/1440/1460 DOS Compatibility Feature (#4460) for the IBM System/360 Model 40 is discussed. The interface of the program with the Disk Operating System is described.

GY27-7166 IBM System/360 36
Operating System and 1130
Disk Monitor System—System/
360 Job Processing from a
Remote 1130/2250 Subsystem—
Program Logic Manual

Program Numbers:
360S-RC-543
1130-CQ-012

“See PLM Note.” (200 pages)

This publication describes the internal logic of the System/360 and 1130 Satellite Graphic Job Processor (SGJP) programs that permit an IBM 2250 Display Unit attached to an IBM 1130 Computing System (referred to as an 1130/2250 subsystem) to be used to define jobs for processing in a remote IBM System/360 Operating System. The jobs are defined and started in response to frames displayed on the 2250 Display Unit by the 1130 program. The information entered at the 2250 is transmitted via a telecommunication line to the System/360 program which converts the information into Job Control Language statements and starts execution of the job.

GY27-7187 IBM System/360 65
Operating System Emulator
Program to Emulate the IBM 709,
7090, 7094 and 7094 II on the
IBM System/360 Model 85

Program Number: 360C-EU-734

This publication describes the internal logic of the IBM/360 709/7090/7094/7094 II Emulator Program for IBM System/360 Model 85. The emulator program is a problem program that executes under the System/360 Operating System MFT or MVT control programs. The emulator program, together with the compatibility feature (#7119), allows programs written for the 709, 7090, 7094, and 7094 II Data Processing systems to be executed on an IBM System/360 Model 85.

The major topics covered are:

- Logic of the emulator program.
- Relationship between the emulator program, the compatibility feature, and the operating system.
- Logic of the tape formatting programs. The tape formatting programs convert 7094 tapes to a record format used by the emulator program and convert emulator program output back to 7094 record format.

This program logic manual is directed to the IBM customer engineer who is responsible for program maintenance.

GY28-2009 IBM System/360 Time 36
Sharing System, System Logic Summary
Program Logic Manual

Program Number: 360G-CL-627

This publication describes the logic of the IBM System/360 Time Sharing System (TSS/360). The emphasis is on describing the interrelationship of system components in performing system functions. Where an individual component is described, only the highest level of logic is discussed.

This program logic manual is directed to the IBM customer engineer who is responsible for program maintenance. It can be used to determine the interrelationship among the various areas of the system, and it enables the reader to relate these areas to the corresponding program logic manuals. (328 pages)

GY28-2011 IBM System/360 Time 36
Sharing System—System Control
Blocks Program Logic Manual

“See PLM Note.” (296 pages)

This publication documents all control blocks which are a part of the Time Sharing System (TSS/360) System. Each control block is described in terms of its function, size, residence, and use by the rest of the system. A diagram gives a graphic picture of each block, and a DSECT listing shows all fields and includes comments on individual fields.

GY28-2012 IBM System/360 Time 36
Sharing System Resident
Supervisor—Program Logic Manual

“See PLM Note.” (216 pages)

GY28-2013 IBM System/360 Time 36
Sharing System Command Lan-
guage Program Logic Manual

“See PLM Note.” (358 pages)

The modules described in this manual process the commands available to the user, manager, administrator, and operator of the time sharing system.

GY28-2014 IBM System/360 Time 37
Sharing System Program Control
System Program Logic Manual

“See PLM Note.” (212 pages)

GY28-2015 IBM System/360 Time 31
Sharing System—System Generation
and Maintenance—Program Logic
Manual

“See PLM Note.” (92 pages)

This manual includes a high level flow of logic from the SYSBLD Prelude, through System Build, Startup Prelude, and Startup to the point where a working system is generated.

GY28-2016 IBM System/360 Time 30
Sharing System Access Methods Program
Logic Manual

Program Number: 360G-CL-627

This publication describes the internal logic of the queued, basic, multiple, virtual, and terminal access methods programs. These programs provide the processing required to perform Input/Output operations for the user. Also discussed are: general data set handling such as OPEN and CLOSE functions, and specific GET/PUT and READ/WRITE operations on data sets of sequential, indexed sequential, and partitioned organization.

This program logic manual is directed to the IBM customer engineer who is responsible for program maintenance. It can be used to locate specific areas of the program, and it enables the reader to relate these areas to the corresponding program listings. Program logic information is not necessary for program operation and use. (116 pages)

GY28-2018 IBM System/360 Time 31
Sharing System—System Service
Routines Program Logic Manual

“See PLM Note.” (156 pages)

PLM Note

Program Logic Manuals describe the internal design or logic of the subject programs. These manuals are intended for persons involved in program maintenance and system programmers who are altering the program design. Program logic information is not necessary for the operation of the program; therefore, distribution of these publications is limited to persons with maintenance and alteration requirements.

GY28-2019 IBM System/360 Time Sharing System FORTRAN IV—Program Logic Manual 25

“See PLM Note.” (664 pages)

GY28-2021 IBM System/360 Time Sharing System Assembler—Program Logic Manual 21

“See PLM Note.” (376 pages)

GY28-2022 IBM System/360 Time Sharing System Time Sharing Support System Program Logic Manual 48

Program Number: 360G-CL-627

This publication describes the internal logic of the IBM System/360 Time Sharing Support System. This program logic manual is directed to the IBM customer engineers involved in program maintenance, and to the system programmers involved in altering the program design. It can be used to locate specific areas of the program, and it enables the reader to relate these areas to the corresponding program listings. Program logic information is not necessary for program operation and use. (20 pages)

GY28-2030 IBM System/360 Time Sharing System Linkage Editor—Program Logic Manual 31

“See PLM Note.” (104 pages)

GY28-2031 IBM System/360 Time Sharing System Dynamic Loader—Program Logic Manual 31

“See PLM Note.” (162 pages)

The dynamic loader assigns virtual storage for a task's program modules and resolves address constants for those pages referenced at execution time. In addition, the dynamic loader deletes modules from the task and performs several housekeeping functions. Library maintenance, a housekeeping function not part of the dynamic loader proper, is also discussed in this manual.

GY28-2039 IBM System/360 Time Sharing System Independent Utilities—Program Logic Manual 32

“See PLM Note.” (66 pages)

GY28-2041 IBM System/360 Time Sharing System Task Monitor Program Logic Manual 36

Program Number: 360G-CL-627

This program logic manual is directed to the IBM customer engineer who is responsible for program maintenance. It can be used to locate specific areas of the program, and it enables the reader to relate these areas to the corresponding program listings. Program logic information is not necessary for program operation and use. (56 pages)

GY28-2042 IBM System/360 Time Sharing System On-Line Test Control Program Program Logic Manual 36

“See PLM Note.” (56 pages)

This publication is intended for use with the appropriate program listings. Its primary purpose is to serve as a guide to those listings.

GY28-6382 IBM System/360 Operating System COBOL (F)—Program Logic Manual 24

*Program Numbers:
360S-CB-524
360S-LM-525*

“See PLM Note.” (187 pages)

GY28-6394 IBM System/360 Disk Operating System FORTRAN IV—Program Logic Manual 25

Program Number: 360N-FO-479

“See PLM Note.” (244 pages)

The FORTRAN IV compiler is a processing program of the IBM System/360 Disk Operating System (DOS). It translates one or more source modules written in the FORTRAN IV language into an object module that can be processed into an executable load module by the linkage editor.

GY28-6564 IBM System/360 Model 40—1410/7010 Emulator Program—Program Logic Manual 35

Program Number: 360C-EU-728

“See PLM Note.” (79 pages)

GY28-6566 IBM System/360 Model 65 709/7090/7094/7094 II Emulator Program—Program Logic Manual 35

Program Number: 360C-EU-729

“See PLM Note.” (128 pages)

This publication describes the internal logic of the 709/7090/7094/7094 II Emulator Program used with Compatibility Feature #7119 to execute 709/7090/7094/7094 II programs on a System/360 Model 65.

GY28-6569 IBM System/360 Model 50 1410/7010 Emulator Program—Program Logic Manual 35

Program Number: 360C-EU-726

“See PLM Note.” (78 pages)

This publication describes the internal logic of the 1410/7010 Emulator Program used with Compatibility Feature #4478 to execute 1410/7010 programs on a System/360 Model 50.

GY28-6597 IBM System/360 Operating System—Sort/Merge—Program Logic Manual 33

Program Number: 360S-SM-023

“See PLM Note.” (112 pages)

This manual can be used to locate specific areas of the program, and it enables the reader to relate these areas to the corresponding program listings.

This version of the sort/merge program is designed to:

1. Sort a data set using as intermediate storage the IBM 2400-Series (7- or 9-track) Magnetic Tape Unit, or the IBM 2311 Disk Storage Drive, or the IBM 2314 Direct-Access Storage Facility, or the IBM 2301 Drum Storage.
2. Merge up to 16 previously sorted data sets.

GY28-6599 IBM System/360 Conversion Aids: The 7040/7044 Emulator Program for IBM System/360 Model 65—Program Logic Manual 35

Program Number: 360C-EU-733

“See PLM Note.” (139 pages)

This publication describes the internal logic of the 7040/7044 Emulator Program used with the Compatibility Feature #7119 to execute 7040/7044 programs on an IBM System/360 Model 65.

GY28-6601 IBM System/360 Operating System FORTRAN IV (E)—Program Logic Manual 25

Program Number: 360S-FO-092

“See PLM Note.” (158 pages)

PLM Note

Program Logic Manuals describe the internal design or logic of the subject programs. These manuals are intended for persons involved in program maintenance and system programmers who are altering the program design. Program logic information is not necessary for the operation of the program; therefore, distribution of these publications is limited to persons with maintenance and alteration requirements.

GY28-6604 IBM System/360 Operating 30
System Sequential Access Methods—
Program Logic Manual

Program Number: 360S-DM-508

"See PLM Note." (57 pages)

This publication describes the internal logic of the routines of the queued sequential access method, the basic sequential access method, and the basic partitioned access method of IBM System/360 Operating System.

GY28-6605 IBM System/360 Operating 36
System Introduction to Control
Program Logic
Program Logic Manual

Program Numbers:
360S-CI-505
360S-DM-508

"See PLM Note." (32 pages)

This publication discusses the components of the primary control program of IBM System/360 Operating System and indicates the program logic manuals that describe these components.

GY28-6606 IBM System/360 Operating 30
System Catalog Management—Program
Logic Manual

Program Number: 360S-DM-508

"See PLM Note." (20 pages)

This manual provides detailed information on catalog management routines. These routines record identification of volumes used by data sets by maintaining information in logical records called indexes. The functions and structures of the routines are described, as are their relationships to other portions of IBM System/360 Operating System. This manual also describes the structure of catalog data sets that contain the indexes processed by catalog management routines.

GY28-6607 IBM System/360 Operating 30
System Direct Access Device Space
Management Program Logic Manual

Program Number: 360S-DM-508

"See PLM Note." (36 pages)

This manual provides detailed information on direct-access device space management (DADSM) routines. These routines control the use of external direct-access storage by maintaining the information in data set control blocks. The functions and

structures of the routines are described, as are their relationships to other portions of IBM System/360 Operating System. This manual also describes the structure of volume tables of contents which are processed by DADSM routines.

GY28-6609 IBM System/360 Operating 30
System Input/Output Support (OPEN/
CLOSE/EOV) Program Logic Manual

Program Number: 360S-DM-508

"See PLM Note." (44 pages)

This manual discusses the relation of I/O support routines to other portions of the control program. Detailed descriptions of the open, close, and EOV routines provide the basis for the discussions of the other I/O support routines openJ, RDJFCB, Tclose, and FEOV.

GY28-6610 IBM System/360 Operating 31
System Linkage Editor—Program
Logic Manual

Program Number: S360-ED-510 (Level E)

"See PLM Note." (148 pages)

This publication describes the internal logic of the 15K, 18K, and 44K versions of the level E linkage editor. The linkage editor combines and edits modules to produce a single load module that can be loaded into main storage by the control program. The linkage editor operates as a processing program rather than as a part of the control program.

GY28-6611 IBM System/360 Operating 37
System TESTRAN—Program Logic
Manual

Program Number: 360S-PT-516

"See PLM Note." (126 pages)

TESTRAN is divided into three parts: the TESTRAN macro-instructions, the TESTRAN interpreter, and the TESTRAN editor. The operation of each of these parts is discussed in detail.

GY28-6612 IBM System/360 Operating 36
System Fixed-Task Supervisor—
Program Logic Manual

Program Number: 360S-CI-505

"See PLM Note." (77 pages)

This publication describes the fixed-task supervisor, which performs task management as a major part of the primary control program of IBM System/360 Operating System. In addition, this manual describes the initial program loader (IPL) and the nucleus initialization program (NIP).

GY28-6613 IBM System/360 Operating 38
System Job Management—Program
Logic Manual

Program Number: 360S-CI-505

"See PLM Note." (128 pages)

Job management prepares jobs for execution, and directs the disposition of data sets created during job execution. It also handles all communication between the operator and the primary control program. Included in the publication are descriptions of tables and work areas used by the Job management routines and a directory of names and purposes of control sections, assembly modules, and load modules. The information contained in this publication applies only to the primary control program.

GY28-6614 IBM System/360 Operating 32
System Utilities—Program Logic Manual

Program Number: 360S-UT-506

"See PLM Note." (83 pages)

System, data set, and independent utility programs are included in this publication.

GY28-6616 IBM System/360 Operating 30
System Input/Output Supervisor—
Program Logic Manual

Program Number: 360S-CI-505

"See PLM Note." (110 pages)

The I/O supervisor's components, the EXCP supervisor, and the I/O interruption supervisor are discussed in detail to show the internal structure and logic involved in the control of I/O devices and channels.

GY28-6617 IBM System/360 Operating 30
System Basic Direct Access Method—
Program Logic Manual

Program Number: 360S-DM-509

"See PLM Note." (72 pages)

The functions and structures of the routines are described, as are their relationships to other portions of the operating system.

GY28-6618 IBM System/360 Operating 30
System Indexed Sequential Access
Methods Program Logic Manual

Program Number: 360S-IO-526

"See PLM Note." (88 pages)

This publication describes the program logic of the two indexed sequential access methods: the queued indexed sequential access method (QISAM) and the basic indexed sequential access method (BISAM). It also discusses the relationship of indexed sequential access method routines to other parts of the control program.

PLM Note

Program Logic Manuals describe the internal design or logic of the subject programs. These manuals are intended for persons involved in program maintenance and system programmers who are altering the program design. Program logic information is not necessary for the operation of the program; therefore, distribution of these publications is limited to persons with maintenance and alteration requirements.

GY28-6638 IBM System/360 Operating 25 **System FORTRAN IV (G) Compiler—** **Program Logic Manual**

Program Number: 360S-FO-520

"See PLM Note." (248 pages)

The FORTRAN IV (G) compiler is a processing program of the IBM System/360 Operating System. It translates one or more source modules written in the FORTRAN language into an object module that can be processed into an executable load module by the Linkage Editor.

GY28-6642 IBM System/360 Operating 25 **System FORTRAN IV (H) Compiler—** **Program Logic Manual**

Program Number: 360S-FO-500

"See PLM Note." (232 pages)

The FORTRAN IV (H) compiler program transforms source modules written in the FORTRAN IV language into object modules that are suitable for input to the linkage editor for subsequent execution on System/360. At the user's option, the compiler produces optimized object modules (modules that can be executed with improved efficiency).

This revision reflects the 5.1 version of the FORTRAN IV (H) compiler program. A number of table formats and intermediate text formats have been changed. The overall operation of the compiler has not changed significantly, but some routines within the program have been changed, new routines have been added, and some routines have been deleted or combined with other routines.

GY28-6645 IBM System/360 Disk 33 **Operating Tape and Disk Sort/Merge—** **Program Logic Manual**

Program Number: 360N-SM-483

"See PLM Note." (128 pages)

This program sorts input records into a single output file having a pre-determined order; it also merges presorted input files into an ordered output file. The sort/merge program:

1. Analyzes control statements and system information provided by the DOS Supervisor and IOCS routines, defines constants, and determines an optimum sort. (Assignment Phase)
2. Sorts logical input records into sequential strings that are distributed onto either tape or direct access intermediate storage devices. (Internal Sort Phase)

3. Merges the strings created during the Internal Sort phase into longer strings. (External Sort Phase)

4. Performs a final merge on either the strings from the intermediate storage devices (for a sort application), or on the pre-sorted input files (for a merge application). (Final Sort/Merge Only Phase)

GY28-6651 IBM System/360 Operating 37 **System On-Line Test Executive** **Program—Program Logic Manual**

Program Number: 360S-DN-533

"See PLM Note." (68 pages)

The On-Line Test Executive Program handles on-line testing of input/output devices under control of the IBM System/360 Operating System.

GY28-6658 IBM System/360 Operating 36 **System MVT Control Program Logic** **Summary Program Logic Manual**

Program Numbers:

360S-CI-535

360S-DM-508

"See PLM Note." (64 pages)

This publication introduces the internal logic of the MVT control program of System/360 Operating System. It contains general descriptions of the operating environment of the control program, the initial program loading procedure, and the job management, task management, data management, and recovery management functions. Detailed descriptions of the implementation of these functions are in the program logic manuals listed in Appendix B.

The MVT configuration of the control program is designed for use with System/360 Models 40, 50, 65, 75, and 91 having 262,144 (256K) bytes or more main storage.

GY28-6659 IBM System/360 Operating 36 **System MVT Supervisor—Program** **Logic Manual**

Program Number: 360S-CI-535

"See PLM Note." (500 pages)

The MVT supervisor is one part of the control program of the IBM System/360 Operating System. The supervisor controls the basic computing system and programming resources needed to perform several data processing tasks concurrently. Specifically, it was designed to:

1. Handle interruptions.
2. Supervise tasks.
3. Control programs in main storage.
4. Control main storage itself.
5. Supervise the timer.
6. Supervise console communications and the system log.
7. Handle checkpoint restarts.
8. Supervise exiting procedures.
9. Supervise termination procedures.

The information in this publication applies only to systems capable of multiprogramming with a variable number of tasks (MVT). It reflects the status of the system at Release 12.

GY28-6660 IBM System/360 Operating 36 **System MVT Job Management—** **Program Logic Manual**

Program Number: 360S-CI-535

"See PLM Note." (188 pages)

This publication describes the internal logic of the job management routines for the MVT control program of the IBM System/360 Operating System. Included are discussions of input stream processing, work queue management, job initiation and termination, I/O device allocation, system output processing, and the scheduling and execution of operator commands.

GY28-6661 IBM System/360 Operating 36 **System Initial Program Loader and** **Nucleus Initialization Program—Program** **Logic Manual**

Program Number: 360S-CI-535

"See PLM Note." (32 pages)

The Initial Program Loader prepares main storage to receive the nucleus and then loads the nucleus. The Nucleus Initialization Program initializes the resident part of the control program and prepares main storage for control program operation. The information in this publication applies only to systems capable of multiprogramming with a variable number of tasks. (MVT).

This publication provides information concerning the ways in which the internal logic of certain routines have been expanded or modified to support the IBM System/360 Model 91.

GY28-6667 IBM System/360 Operating 31 **System Linkage Editor (F)—** **Program Logic Manual**

Program Number: S360-ED-521

"See PLM Note." (184 pages)

This publication describes the internal logic of the IBM System/360 Operating System Linkage Editor (F), Version 2, with design points of 44K, 88K, and 128K. It identifies areas of the program that perform specific functions and relates those areas to the program listing.

The linkage editor, a processing program, combines and edits modules to produce a load module that can be loaded into main storage by the control program. The linkage editor:

1. Allocates storage, analyzes attributes and options, and initializes tables and buffers. (Initialization)
2. Transforms input into an internal format for subsequent processing. (Input Processing)
3. Assigns relative storage addresses to external symbols, writes records on the output data set, and produces an optional module map and/or cross-reference table. (Intermediate Processing)
4. Relocates address constants found in the input text, and writes the remaining records on the output data set. (Second Pass Processing)
5. Completes the partitioned data set directory for the output data set, produces an error diagnostic directory, and releases storage allocated to the linkage editor. (Final Processing)

PLM Note

Program Logic Manuals describe the internal design or logic of the subject programs. These manuals are intended for persons involved in program maintenance and system programmers who are altering the program design. Program logic information is not necessary for the operation of the program; therefore, distribution of these publications is limited to persons with maintenance and alteration requirements.

GY28-6681 IBM System/360 Operating System Release 15/16 36

"See PLM Note." (340 pages)

This document outlines the current status, new features/functions, and incremental improvements to System/360 Operating System. A list of all modules added, deleted, or altered for this release is also included. System Prose and Maintenance Prose in the form APARS, PSI entries, and PTFS inform the user of the current maintenance status of the system.

LY28-6696 IBM System/360 Disk Operating System: Tape and Disk Sort/Merge Program, Program Logic Manual 33

Program Number: 5736-SM1

This publication describes the internal logic of the IBM System/360 Disk Operating System Tape and Disk Sort/Merge Program. It describes the functions performed by specific areas of the program and is intended to be used by persons involved in program maintenance or by systems programmers who are altering the program design. It is not needed for normal use or for operation of the program. In addition to the functional descriptions, this publication contains flowcharts, a microfiche directory, table layouts, and diagnostic aids. (140 pages)

GY28-6800 IBM System/360 Operating System PL/I (F) Compiler—Program Logic Manual 29

Program Number: 360S-NL-511

"See PLM Note." (238 pages)

This manual is aimed at personnel responsible for analyzing program operations, diagnosing mal-function, and changing the program format for special or national language usage. The information provides a guide for effective use of the program listings.

GY28-6801 IBM System/360 Operating System PL/I Subroutine Library—Program Logic Manual 29

Program Number: 360S-LM-512

"See PLM Note." (117 pages)

This publication describes the internal specifications of the PL/I Subroutine Library as a system component of IBM Operating System/360. The

relationships between the code produced by the PL/I(F) compiler, the PL/I Library modules and the control program are described, and summaries of the properties of individual modules are provided.

GY28-6811 IBM System/360 Model 44 Programming System Assembler Program Logic Manual 21

Program Number: 360F-AS-616

"See PLM Note." (139 pages)

GY28-6812 IBM System/360 Model 44 Programming System Supervisor and Job Control—Program Logic Manual 36

Program Numbers:

360F-IO-613

360F-CL-614

"See PLM Note." (228 pages)

GY28-6813 IBM System/360 Model 44 Programming System Linkage Editor Program Logic Manual 31

Program Number: 360F-ED-615

"See PLM Note." (131 pages)

The linkage editor combines and edits modules to produce a single load phase that can be loaded into main storage by the control program. The linkage editor operates as a processing program rather than as a part of the control program.

GY28-6814 IBM System/360 Model 44 Programming System Utilities and Stand-alone Programs—Program Logic Manual 32

Program Numbers:

360F-UT-606

360F-UT-607

360F-UT-608

360F-UT-609

360F-UT-610

360F-UT-611

360F-UT-612

360F-UT-617

360F-UT-620

"See PLM Note." (172 pages)

GY28-6815 IBM System/360 Model 44 Programming System FORTRAN IV Compiler—Program Logic Manual 25

Program Number: 360F-FO-618

"See PLM Note." (231 pages)

The FORTRAN IV compiler is a processing program of the IBM System/360 Model 44 Programming System. It translates a source module written in the FORTRAN IV language into an object module that can be processed into an executable load module by the Model 44 linkage editor.

GY28-6816 IBM System/360 Conversion Aids: 1620 Simulator for IBM System/360 Model 44—Program Logic Manual 35

Program Number: 360C-SI-755

"See PLM Note." (112 pages)

The 1620 simulator is a conversion aid that executes object programs written for an IBM 1620 Model 1 or Model 2 Data Processing System on an IBM System/360 Model 44. The purpose of the simulator is to aid the user during the period of transition from a 1620 installation to a System/360 Model 44.

GY28-6831 IBM System/360 Operating System FORTRAN IV Syntax Checker 25

Program Number: 360S-FO-550

This publication describes the internal logic of the FORTRAN IV Syntax Checker, which is a component of the IBM System/360 Operating System Conversational Remote Job Entry (CRJE). Thus, the reader is required to have a knowledge of FORTRAN IV and an understanding of the concepts and facilities of CRJE. The publication identifies areas of the syntax checker that perform specific functions and relates those areas to the program listings.

The FORTRAN IV Syntax Checker, a processing program called via the terminal command language of CRJE, scans input written for the E, G, or H levels of the FORTRAN IV language for syntactical errors. The input is checked on a single-statement basis, i.e., no cross-checking between statements is performed. The syntax checker:

- receives FORTRAN source statements in a chain of buffers from CRJE.
- Scans these statements for errors; multiple errors in one statement are diagnosed whenever possible.
- sends appropriate error messages to CRJE for printing at the user's terminal.

This program logic manual is directed to the IBM customer engineer who is responsible for program maintenance. Because program logic information is not necessary for program operation and use, distribution of this manual is restricted to persons with program maintenance responsibilities. (128 pages)

LY28-6832 IBM System/360 OS/DOS ITF Program Logic Introduction and Method of Operation 31

Program Numbers: 5734-RC1

5734-RC3

5736-RC1

5736-RC2

This publication describes the internal logic of the Interactive Terminal Facility (ITF) that operates under System/360 Operating System (OS) or System/360 Disk Operating System (DOS). It is intended for use by persons involved in program maintenance. Program logic information is not necessary for the use and operation of the ITF; therefore, distribution of this publication is limited to licensees who have the aforementioned requirement.

PLM Note

Program Logic Manuals describe the internal design or logic of the subject programs. These manuals are intended for persons involved in program maintenance and system programmers who are altering the program design. Program logic information is not necessary for the operation of the program; therefore, distribution of these publications is limited to persons with maintenance and alteration requirements.

This publication is one section of the ITF program logic manual. Please refer to the Preface for a list of other sections that, together with this one, form the ITF program logic manual. (66 pages)

LY28-6833 IBM System/360 OS/DOS 31
**ITF Program Logic Initialization,
System Control, and System Support**

*Program Numbers: 5734-RC1
5734-RC3
5736-RC1
5736-RC2*

This publication describes the internal logic of the Interactive Terminal Facility (ITF) that operates under System/360 Operating System (OS) or System/360 Disk Operating System (DOS). It is intended for use by persons involved in program maintenance. Program logic information is not necessary for the use and operation of the ITF; therefore, distribution of this publication is limited to licensees who have the aforementioned requirement.

This publication is one section of the ITF program logic manual. Please refer to the Preface for a list of other sections that, together with this one, form the ITF program logic manual. (270 pages)

LY28-6834 IBM System/360 OS/DOS 29
**ITF Program Logic Manual, Language
Component: Contoller**

*Program Numbers: 5734-RC1
5734-RC3
5736-RC1
5736-RC2*

(10 pages) No abstract available.

LY28-6835 IBM System/360 OS/DOS 29
**ITF Program Logic Language
Component: PL/I Routines**

*Program Numbers: 5734-RC1
5734-RC3
5736-RC1
5736-RC2*

This publication describes the internal logic of the Interactive Terminal Facility (ITF) that operates under System/360 Operating System (OS) or System/360 Disk Operating System (DOS). It is intended for use by persons involved in program maintenance. Program logic information is not necessary for the use and operation of the ITF;

therefore, distribution of this publication is limited to licensees who have the aforementioned requirement.

This publication is one section of the ITF program logic manual. Please refer to the Preface for a list of other sections that, together with this one, form the ITF program logic manual. (102 pages)

LY28-6836 IBM System/360 OS/DOS 23
**ITF Program Logic Language Component:
Basic Routines**

*Program Numbers: 5734-RC1
5734-RC3
5736-RC1
5736-RC2*

This program describes the internal logic of the Interactive Terminal Facility (ITF) that operates under System/360 Operating System (OS) or System/360 Disk Operating System (DOS). It is intended for use by persons involved in program maintenance. Program logic information is not necessary for the use and operation of the ITF; therefore, distribution of this publication is limited to licensees who have the aforementioned requirement.

This publication is one section of the ITF program logic manual. Please refer to the Preface for a list of other sections that, together with this one, form the ITF program logic manual. (170 pages)

LY28-6837 IBM System/360 OS/DOS 31
**ITF Program Logic Language Component:
Common Routines and Reference Data**

*Program Numbers: 5734-RC1
5734-RC3
5736-RC1
5736-RC2*

This publication describes the internal logic of the Interactive Terminal Facility (ITF) that operates under System/360 Operating System (OS) or System/360 Disk Operating System (DOS). It is intended for use by persons involved in program maintenance. Program logic information is not necessary for the use and operation of the ITF; therefore, distribution of this publication is limited to licensees who have the aforementioned requirement.

This publication is one section of the ITF program logic manual. Please refer to the Preface for a list of other sections that, together with this one, form the ITF program logic manual. (138 pages)

LY28-6840 IBM System/360 OS/DOS 20
ITF Program Logic Index

*Program Numbers: 5734-RC1
5734-RC3
5736-RC1
5736-RC2*

This publication describes the internal logic of the Interactive Terminal Facility (ITF) that operates under System/360 Operating System (OS) or System/360 Disk Operating System (DOS). It is intended for use by persons involved in program maintenance. Program logic information is not

necessary for the use and operation of the ITF; therefore, distribution of this publication is limited to licensees who have the aforementioned requirement.

This publication is one section of the ITF program logic manual. Please refer to the Preface for a list of other sections that, together with this one, form the ITF program logic manual. (60 pages)

GY28-7106 IBM System/360 Operating 32
**System Update Analysis Program
Program Logic Manual**

This publication describes the internal logic of the Update Analysis Program, a component of the IBM System/360 Operating System. The publication is intended for use by persons involved in program maintenance, and system programmers who are altering the program design. Program logic information is not necessary for use and operation of the program; therefore, distribution of this publication is limited to those with the aforementioned requirements. (21 pages)

GY30-2001 IBM System/360 Operating 30
**System Basic Telecommunications
Access Method—Program Logic Manual**

Program Number: 360S-CQ-513

"See PLM Note." (184 pages)

GY30-2002 IBM System/360 Operating 30
**System Queued Telecommunications
Access Method Program Logic Manual**

Program Number: 360S-CQ-519

"See PLM Note." (For Option 2) (188 pages)

GY30-2005 IBM System/360 Operating 36
**System Remote Job Entry—
Program Logic Manual**

Program Number: 360S-RC-536

"See PLM Note." (256 pages)

GY30-2006 IBM System/360 Basic 36
**Operating System, Basic Programming
Support Remote Job Entry Work
Station Program, Program Logic Manual**

*Program Numbers: 360B-CQ-311 (BOS)
360P-CQ-218 (BPS)*

This Program Logic Manual describes the internal logic of the Remote Job Entry Work Station Program under the IBM System/360 Basic Operating System or IBM System/360 Basic Programming support. This publication is directed to the IBM

PLM Note

Program Logic Manuals describe the internal design or logic of the subject programs. These manuals are intended for persons involved in program maintenance and system programmers who are altering the program design. Program logic information is not necessary for the operation of the program; therefore, distribution of these publications is limited to persons with maintenance and alteration requirements.

customer engineer who is responsible for program maintenance. It can be used to locate specific areas of the program, and it enables the reader to relate these areas to the program listings. Because program logic information is not necessary for program operation and use, distribution of this manual is restricted to persons with program maintenance responsibilities. (47 pages)

GY30-2011 IBM System/360 Operating System Conversation Remote Job Entry Program Logic Manual 36

Program Number: 360S-RC-551

This publication describes the internal logic of the Conversational Remote Job Entry (CRJE) facility of the IBM System/360 Operating System (OS). CRJE provides Remote Job Entry capability for users at remote keyboard terminals that are connected to an IBM System/360 via communication lines.

This program logic manual is intended for use by personnel involved in program maintenance and by system programmers who are altering the system design. (424 pages)

GY30-5001 IBM System/360 Disk Operating System—Basic Telecommunications Access Method—Program Logic Manual 30

Program Number: 360N-CQ-469

"See PLM Note." (296 pages)

GY30-5002 IBM System/360 Disk Operating System Queued Telecommunications Access Method—Program Logic Manual 30

Program Number: 360N-CQ-470

"See PLM Note." (200 pages)

Y33-6003 IBM System/360 PL/I Language Specifications 99

This publication is a description of the PL/I language. It does not describe any implementation; nor can it be construed that the publication implies any commitment that the features are implemented or will be implemented by IBM. The publication is intended for the use of implementers and programming language designers concerned with language development and the study of languages. (216 pages)

GY33-6020 IBM System/360 Operating System: PL/I (F) Version 5 Independent Component Release 36

This publication consolidates documents outlining the status and use of the independent release of PL/I (F) Version 5. New features are noted, and information is provided on the system generation requirements and techniques. A list of all modules added, deleted or altered for this release is included. System Prose informs the user of the current maintenance status of PL/I (F).

IBM provides an operating system that can be used for the system generation. The procedures required to initialize the starter system are also described in this publication. (112 pages)

GY33-7000 IBM System/360 Conversion Aids: FORTRAN IV-to-PL/I Language Conversion Program for IBM System/360 Operating System—Program Logic Manual 29

Program Number: 360C-CV-710

"See PLM Note." (96 pages)

GY33-7006 IBM System/360 Conversion Aids: ALGOL-to-PL/I Language Conversion Program for IBM System/360 Operating System—Program Logic Manual 29

Program Number: 360C-CV-711

"See PLM Note." (92 pages)

GY33-8000 IBM System/360 Operating System ALGOL (F) Compiler—Program Logic Manual 26

*Program Numbers:
360S-AL-531 (ALGOL Compiler)
360S-LM-532 (ALGOL Library)*

"See PLM Note." (318 pages)

The ALGOL (F) Compiler is a processing program of the IBM System/360 Operating System. It translates a source module written in the ALGOL language into an executable load module by the Linkage Editor.

GY33-9010 IBM System/360 Disk and Tape Operating Systems PL/I Subset Language (Volume 1 of 3)—Program Logic Manual 29

*Program Numbers:
360N-PL-464 (DOS)
360N-PL-410 (TOS)*

"See PLM Note." (422 pages)

This publication is divided into three volumes. Volume 1 contains the description of the compiler phases; volumes 2 and 3 contain the corresponding flow charts. The form numbers of the three volumes are:

Volume 1: GY33-9010
Volume 2: GY33-9011
Volume 3: GY33-9012

All information regarding the library subroutines of the DOS/TOS PL/I compiler is contained in the publication *IBM System/360 Disk and Tape Operating Systems, PL/I Subset-Library Routines, Program Logic Manual*, Order Number GY33-9013.

The reader must be thoroughly familiar with the IBM System/360 Disk and Tape Operating Systems and with the PL/I Subset language. A list of all publications that provide pertinent information is contained in the introduction to volume 1 of this PLM.

GY33-9011 IBM System/360 Disk and Tape Operating Systems PL/I Subset Language (Volume 2 of 3)—Program Logic Manual 29

*Program Numbers:
360N-PL-464 (DOS)
360N-PL-410 (TOS)*

"See PLM Note." (516 pages)

The publication is divided into three volumes. Volume 1 contains the description of the compiler phases; volumes 2 and 3 contain the corresponding flow charts. The form numbers of the three volumes are:

Volume 1: GY33-9010
Volume 2: GY33-9011
Volume 3: GY33-9012

All information regarding the library subroutines of the DOS/TOS PL/I compiler is contained in the publication *IBM System/360 Disk and Tape Operating Systems, PL/I Subset-Library Routines, Program Logic Manual*, Order Number GY33-9013.

The reader must be thoroughly familiar with the IBM System/360 Disk and Tape Operating Systems and with the PL/I Subset language. A list of all publications that provide pertinent information is contained in the introduction to volume 1 of this PLM.

GY33-9012 IBM System/360 Disk and Tape Operating Systems PL/I Subset Language (Volume 3 of 3)—Program Logic Manual 29

*Program Numbers:
360N-PL-464 (DOS)
360N-PL-410 (TOS)*

"See PLM Note." (448 pages)

The publication is divided into three volumes. Volume 1 contains the description of the compiler phases; volumes 2 and 3 contain the corresponding flow charts. The form numbers of the three volumes are:

Volume 1: GY33-9010
Volume 2: GY33-9011
Volume 3: GY33-9012

All information regarding the library subroutines of the DOS/TOS PL/I compiler is contained in the publication *IBM System/360 Disk and Tape Operating Systems, PL/I Subset-Library Routines, Program Logic Manual*, Order Number GY33-9013.

The reader must be thoroughly familiar with the IBM System/360 Disk and Tape Operating Systems and with the PL/I Subset language. A list of all publications that provide pertinent information is contained in the introduction to volume 1 of this PLM.

PLM Note

Program Logic Manuals describe the internal design or logic of the subject programs. These manuals are intended for persons involved in program maintenance and system programmers who are altering the program design. Program logic information is not necessary for the operation of the program; therefore, distribution of these publications is limited to persons with maintenance and alteration requirements.

GY33-9013 IBM System/360 Disk and Tape Operating Systems—PL/I Subset—Library Routines—Program Logic Manual 29

Program Numbers:

360N-PL-464 (DOS)

360N-PL-410 (TOS)

"See PLM Note." (168 pages)

This publication contains information on (1) the characteristics of the library and the calling conventions used and (2) the structure and functions of the various routines.

The reader of this publication should be familiar with the SRL publications:

IBM System/360 Disk and Tape Operating Systems, PL/I Subset Language Specifications, Order Number GC28-6809

IBM System/360 Disk and Tape Operating Systems, Assembler Specifications, Order Number GC24-3414

For a list of further related publications, refer to *IBM System/360 Bibliography*, Order Number GA22-6822.

READER'S COMMENT FORM

IBM S/360 and S/370

GA22-6822-16

Bibliography

Please comment on the usefulness and readability of this publication, suggest additions and deletions, and list specific errors and omissions (give page numbers). All comments and suggestions become the property of IBM. If you wish a reply, be sure to include your name and address.

COMMENTS

—
fold

—
fold

—
fold

—
fold

- Thank you for your cooperation. No postage necessary if mailed in the U.S.A.
FOLD ON TWO LINES, STAPLE AND MAIL.

YOUR COMMENTS PLEASE...

Your comments on the other side of this form will help us improve future editions of this publication. Each reply will be carefully reviewed by the persons responsible for writing and publishing this material.

Please note that requests for copies of publications and for assistance in utilizing your IBM system should be directed to your IBM representative or the IBM branch office serving your locality.

fold

fold

FIRST CLASS
PERMIT NO. 1359
WHITE PLAINS, N. Y.

BUSINESS REPLY MAIL
NO POSTAGE NECESSARY IF MAILED IN THE UNITED STATES

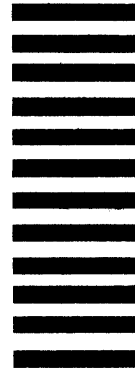

POSTAGE WILL BE PAID BY ...

IBM Corporation
112 East Post Road
White Plains, N. Y. 10601

Attention: Technical Publications

fold

fold



International Business Machines Corporation
Data Processing Division
112 East Post Road, White Plains, N.Y. 10601
[USA Only]

IBM World Trade Corporation
821 United Nations Plaza, New York, New York 10017
[International]



**International Business Machines Corporation
Data Processing Division
112 East Post Road, White Plains, New York 10601
(USA only)**

**IBM World Trade Corporation
821 United Nations Plaza, New York, New York 10017
(International)**